



20

20

Jakobs®

EN



Jakobs®

Being a wholesale we offer tricycles, bikes and trikes for children, movement play equipment, toys, products for motor activity, didactics, therapy, sports and fitness. Our product range includes exclusive brand products and company-owned products for kindergarten, nursery, after-school and school, products for hobby, school and club sports as well as for fitness and therapy and the elderly sector. Our product range stands for quality, sustainability and safety, play value and fun, movement and social interaction, functionality and innovation.

The year 2020 is - graphically speaking - something special. We tried to fill this special feature with content and present new, interesting products with innovative and/or environmentally friendly aspects and high learning content.

With our steel tongue drums "TONGO-GO" we are addressing a completely new learning area. Early musical education with beautiful melodic tones that do not require any special technique.

The issue of sustainability has become increasingly important. Fortunately, there are now more and more manufacturers and producers who manufacture products from ecologically harmless materials that meet with great attention and demand. In particular the Danish company dantoy has extended its product portfolio of bio-plastic products. They developed an environmentally friendly, safe toy line in beautiful, matt pastel colours for the little ones. The topic of sustainability also includes recycling: Stapelstein and Kreiselstein "PHOENIX" are made of 100% recycled material. The bucket stilts "NATURE" by Jakobs are made from 50% renewable raw materials.

In the field of magnetic games we have newly developed and designed our classic EasyTip as a magnetic variant: EasyTip MAGNET is a challenge that is fun!

You will find an overview with further novelties on the next two pages.

Yours Jakobs GmbH

Ludolf Jakobs, Leo Jakobs



didacta
Verband der Bildungswirtschaft

With effect from December 7th, 2012 Jakobs GmbH has been granted by the main customs office of Aachen the status of an "Authorized Economic Operator Full" (AEOF).

Jakobs is official sponsor of Fortuna Köln: The special football club from South-Cologne with one of the largest children and youth section in Germany.



Our latest WINTHER Catalogue 2019/2020 with trikes, bikes and more for children and the Turtle Kiddy Bus collection is available separately.



In our current LEGO® Education Brochure you will find selected sets especially for the kindergarten area for the age group 1½ - 5 years

Elementary sector • Kindergarten • School

Children's Vehicles for crèches, kindergartens und schools

- WINTHER • 4-41
 - Turtle Kiddy Bus Collection 4-9
 - **Jakobs** • CABORunner® 10-11
 - MINI VIKING 12-17
 - VIKING 18-24
 - VIKING CHALLENGE 25-27
 - VIKING EXPLORER 28-31
 - Bike Trailer Dolphin & Donkey 32
 - Jaalinus Children's Vehicles 33-35
Jakobs own brand in well-known WINTHER quality
 - **Jakobs aktiv** Children's Vehicles 36-41
The well-priced alternative in well-known WINTHER quality

Active Play equipment • Motor activity • Stimulants

- GONGE • 42-55
 - Motor activity • Movement • Play
- Jakobs** • 56-74
 - Motor activity • Movement • Play
 - Rolleppo 66 • Stapelsteine & Kreiselstein 68-69 • Bucket stilts NATURE 72*
- SPORDAS • 75-85
 - Motor activity • Movement • Play
 - Sensoric & Stimulants • 85-87
Sensorics products • Water columns • Fumbling Blankets

Didactic • Games, Learning materials, Dolls

- *Rubens Barn* • Therapy dolls 88-93
- DORON • Wooden Puzzle & Games 94-97
- 3D Puzzle und Baseplates for LEGO® and DUPLO® Elements 98-99
- *Apitor SuperBot Robotik System 99 • LIGHT StAX products 100-101*
- *Playtable for LEGO® und DUPLO® • LEGO® Education products 102-103*
- TOLO Education products 104
- Speech and language therapy 105-107
- Jakobs** • 108-131
 - Didactic Games & Materials 108-123 • *EasyTip Magnet 109*
 - Magnetic Games 111-121 • *DOKUMAG® 115 • Ball Run 119*
 - *Magnetic Play Table Mouse 120 • tegu Magnetic Wooden Blocks 121*
 - *Steel Tongue Drums TONGO-GO 122-123*
 - Wall Units 124-129 • Making & Painting 130-131

Sandpit Toys • Garden Tools for children für Kinder • 'treford

- *Dantoy* • Sandpit Toys • Kitchen Sets 132-141
- *First Tools* • Garden Tools for children 142-144
- **Jakobs** • Sandpit Toys • Willow Cabins 145
- *treford* • Broadloom • Carpets with overlock 146-149

Sport • Therapy • Fitness

Sport • Gymnastics • Fitness • Therapy

- Jakobs**
 - Sport • Gymnastics • Fitness • Therapy 150-157 *Gym mats 152*
 - *Hovoboard® - Standing and Balance Board 158-159*
 - Products for Therapy, Physiotherapy, Occupational Therapy and Rehabilitation 158-165 • *TheraBeans 161*
 - *Thera-Band* Products 166-169

Gymnastic Balls • Sport Balls • Play Balls

- GYMNIC 170-179 • *Rody 179*
- TOGU 180-189 • *Play Balls 189*

- WINTHER • *Bike Trailer Marlin • Cargo Bicycle C29 190*

- Index 191-192



Bucket Stilts NATURE page 72



Rubens Mini EcoBuds page 91



BIOBUDDI® Special Set page 103



Dantoy® tiny page 132

New Products 2020

winther
LEARNING BY MOVING



Walkabout vehicles
page 27



new GONGE products
page 50 / 51



Boxing Base 140
page 61



ROLLEPPO®
page 66

joboo®



Stapelstein SAFARI & PHOENIX
page 68

Buba Bloon



BubaBloon
page 84

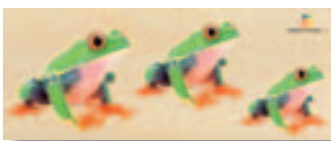

Puzzles Size & Depth Set of 3
page 97

Apitor



Apitor SuperBot Robotic System
page 99



EasyTip MAGNET
page 109



MagniRoll®
page 119



**TONGO-GO
Stahlzungenrömmel**
page 122 / 123

Sales and distribution:

+49 (0) 2426 904 66 0
+49 (0) 2426 904 66 12-15
Fax +49 (0) 2426 904 66 22
Email: info@jakobs.de

- On request all orders are delivered by drop-shipment without extra charge

Turtle Kinderbus



Kinderbus E-Turtle • Winther



Turtle Kiddy Bus Models



8900801
Kiddy Bus 6-seater



8900802
Turtle Kiddy Bus 4-seater



8900800
Turtle Kiddy Bus 4-seater de luxe

E-Turtle Models (with motor)

- 8901801
E-Turtle 6-seater
- 8901802
E-Turtle 4-seater



VIDEO



8901801

E-Turtle 6-seater

The Turtle Kiddy Bus is now available with electric motor! Easily to steer, thus it is more comfortable to negotiate gradients. The control panel is placed directly at the steering and is easy in handling. Smooth control of velocity enables driving forwards and backwards. The Kiddy Bus brakes automatically, if the steering is released. The E-Turtle is constructed with the result that only adults can control it. It only drives after the parking brake is released. After stops of five minutes or more, the motor switches off. There is a display of the batteries state of charge. The motor is not visible from the outside and runs about six hours in flat terrains. Delivered completely mounted.

In addition to these features the E-Turtle complies with the same safety features and the same equipment as the non-electric Turtle Kiddy Busses. The storage tray is included in the delivery of the E-Turtle (volume 35 l). According accessories will be offered as separate items.

For children aged 6 months up to 4 years (max. 15 kg).

- Engine performance: 24 V, 380 watt (2 x 12 V batteries, capacitance 22 Ah)
- Charge time: 6-8 hours for fully charged battery
- Velocity: 6 km/h forwards, 2 km/h backwards
- L.: 175 cm , W.: 75 cm, H.: 100 cm
- Roll bar L.: 93, W.:65, H.: 46 cm
- Load up to 100 kg
- Own weight: 74,5 kg

Identically constructed available as:

8901802

E-Turtle 4-seater

(own weight 61,5 kg; 155 x 75 x 100 cm, load up to 70 kg).

- Technical modifications/ detailed modifications reserved

8901802

E-Turtle 4-seater



VIDEO



E-Turtle (with motor)

8901801
E-Turtle 6-seater



Accessories



8819054 Babyseat

(max. 2 can be mounted)

Can be placed in 2 positions. If the baby is less than 6 months, the seat can be placed in flat position (takes up 2 seats). If more than 6 months place the seat as shown. Coat covered with cotton blended fabric.



8919082 Rain cover

The rain cover is simply laid over the roll bar and fixed to the roll bar with Velcro tape. It provides protection for light rain as well as driving rain from the sides, however, it is not waterproof as such, as it is necessary with openings in certain places to ensure ventilation.



8819131 Canopy

The sun protection consists of two parts and is attached to the rollover bar with Velcro tape. The sun protection can be pulled apart and pulled together again, so that no new installation is necessary.



Footmuff for 2 children
for Turtle Kiddybus 8900801, 802, 800



8816000
Footmuff for 2 small children
for Turtle Kiddybus 8900801, 802, 800

To keep little children warm when going out with the Turtle Kiddybus in the cold season, we offer this protecting footmuff for 2 small children and 2 side-by-side seats in a Turtle Kiddybus as a useful accessory. The footmuff provides warmth and security, the inner-lining is made of cuddly fur fabric, that keeps nice and warm. The outside is made of resistant, wind and water proof nylon fabric. The special openings in the footmuff allow to led and to fasten the seat belts of the Turtle Kiddybus, so that all children can sit not only warm but also safe. The footmuff is machine washable in a gentle cycle of 40 degree. Material have been checked on harmless. Length: 90 cm, width: 74 cm, weight: 1,3 kg
Age: for small children until the age of 3

8900975
Buggy 4 Kids ST 4

The frame is made from sturdy aluminium. The fabric panels, seats and storage compartment are made from washable polyester. The stroller is approved according to the EN 1888 safety standard. It is equipped with lightweight swivel wheels in front and a parking brake in the back. The seats are comfortable, each fitted with a 5-point seatbelt. The rear seat is adjustable and can be reclined into sleeping position. The stroller is delivered with adjustable and detachable canopies. It has a large storage compartment underneath the seat. The stroller is easy to fold for storage or to take with you in the car. 2 years warranty on the stroller in general, and 1 year on wearing parts. User instruction is included with the stroller.

- Room for 4 children aged 6-36 month
- Comply with EN1888.
- Dimensions (LW/H): 114 x 78 x 110 cm
- Dimensions folded (LW/H): 130 x 86.5 x 51.5 cm
- Carrying capacity: 18 kg each seat
- Front wheel 8" and rear wheel 10"
- Product weight 22.4 kg
- Shipping weight 30.5 kg
- Shipping dimensions: 75 x 28.5 x 126.5 cm
- Shipping volume: 0,27 cbm

Well-thought-out details

1. Easy to fold and doesn't take up much space
 2. Rear seat can recline into sleeping position
 3. Fits through most doorways
 4. Large full-length storage compartment
 5. Pocket for each child at the back
- ! The front bench seat is rigid

8900976
Rain cover for Buggy 4 Kids ST 4
Rain cover for usage during the ride.



Buggy 4 Kids ST 4



Rain cover



Turtle Kiddy Bus

The Turtle Kiddy Bus makes children want to go for lots of outdoor rides. It makes outdoor activities easier and safer for both children and adults. The Kiddy Bus is not only robust, but also features a well-thought-out design that focuses on safety, durability and ergonomics, combined with a number of practical details. The Kiddy Bus is a great advantage in day care centres, crèches and kindergartens. It is also a boost to places like fun parks, theme parks and zoological gardens. The Kiddy Bus is only 75 cm wide, so it easily fits through normal doorways, checkouts and into lifts. Suitable for paved streets and paths.

The Kiddy Bus is made of plastic and aluminium, which keeps it extremely light and makes the vehicle very easy to push. The front wheels swivel, which makes it easy to manoeuvre and change direction. This also means there is no need to lift the Kiddy Bus to turn corners. The children sit in pairs opposite each other. The Turtle Kiddy Bus brakes automatically if someone loses the grip.

8900801

Kiddy Bus 6-seater

- Room for 6 children aged 0-4
- Delivered fully assembled
- Fits through doorways
- Room for storage
- Made of hard-wearing UV-resistant polyethylene and hardened aluminium
- Puncture-proof rubber tyres. Front wheels pivot 360°
- Rear wheels with drum brakes and automatic brakes for parking
- Wheels with industrial ball bearings
- Mechanical brake shoe working on the rear wheels. Automatic brakes for parking
- Easy to fasten safety belts
- Seat belts and seats cushions can be taken off and washed at max. 30°C/86°F
- Warranty: 2 years on chassis, body and wheels
- Safety reflectors for added visibility in the dark
- Dimensions: L 175 cm x W 75 cm x H 105 cm
- Height of step : 22 cm
- Carrying capacity : 100 kg
- Product weight: 41 kg
- Shipping weight: 56 kg
- Shipping volume: 1.638 cbm



Turtle Kiddy Bus 6-seater

VIDEO



Accessories



8819092 Rain cover

The bus must be equipped with 2 canopies at least, as the raincover is to be mounted on top of these. It provides protection for light rain as well as driving rain from the sides, however, it is not waterproof as such, as it is necessary with openings in certain places to ensure ventilation.



8815624 Storage tray

Packed lunches, clothes and other items are secure in the storage tray. L 52 cm, W 35 cm, H 31 cm, weight 2,2 kg. Has room for 35 lts. Max. 10 kg.



8819054 Babyseat

(max. 2 can be mounted)
Can be placed in 2 positions. If the baby is less than 6 months, the seat can be placed in flat position (takes up 2 seats). If more than 6 months place the seat as shown. Coat covered with cotton blended fabric.



8831324 Canopy

Made of sun reflecting fabric. One canopy shades two seats. 67 x 30 cm, inclusive bar 40 cm high.



8819091 Storage cover

Practical rainhood that provides extra protection and keeps the Kiddy Bus dry and clean.



The brake loop helps you keep a firm grip on the Kiddy Bus. If you let go of the handle the loop disengages automatically.



The foot rail makes it easier to manoeuvre the Kiddy Bus around kerbs and rough surfaces.



The **Turtle Kiddy Bus 4-seater de luxe** features more comfortable equipment components in addition: It is fitted with hoods that protect children from wind, shower and the sun. An extra hood in the centre makes the Kiddy Bus closed off. Children can sit with their lunches or toys placed between them on a table. The table can easily be stored under the front seats. The 35-litre capacity storage tray has room for luggage. The Kiddy Bus is fitted with straps on the sides, so children can hold on when walking alongside. Suitable for paved streets and paths.

8900800

Turtle Kiddy Bus 4-seater de luxe

- Room for four children aged 6 months up to 4 years (max. 15 kg)
- Delivered fully assembled with hood, tabel and storage tray
- Fits through doorways
- Room for storage
- Made of hard-wearing, UV-resistant polyethylene and hardened aluminium
- Puncture-proof rubber tyres. Front wheels pivot 360°
- Wheels with industrial ball bearings
- Drum brakes on the rear wheels with and automatic brakes for parking
- Easy to fasten safe belts
- Seat belts and seat cushions can be taken off and washed at 30°C/86°F
- Warranty 2 years on chassis, body and wheels
- Safety reflectors for added visibility in the dark
- Dimensions: L 155 x W 75 x H 100 cm
- Height of step 22 cm
- Carrying capacity: 70 kg
- Product weight 40 kg,
- Shipping weight 55, shipping volume 1.393 cbm

**Turtle Kiddy Bus
4-seater de luxe**



Accessories



8819054 Babyseat

(max. 2 can be mounted)
Can be placed in 2 positions. If the baby is less than 6 months, the seat can be placed in flat position (takes up 2 seats). If more than 6 months place the seat as shown. Coat covered (cotton blended fabric).

8819095 Storage cover for 8900800

Practical rainhood that provides extra protection and keeps the Kiddy Bus dry and clean.

Color varies!



35 L

Details



The **Turtle Kiddy Bus 4-seater** has the same features as the 6-seater, but without doors and floor mat. Suitable for paved streets and paths.

8900802

Turtle Kiddy Bus 4-seater

- Room for four children aged 6 months up to 4 years (max. 15 kg)
- Basic version delivered fully assembled
- Fits through doorways
- Room for storage
- Made of hard-wearing UV-resistant polyethylene and hardened aluminium
- Puncture-proof rubber tyres. Front wheels pivot 360°
- Wheels with industrial ball bearings
- Drum brakes on the rear wheels with and automatic brakes for parking
- Easy to fasten safe belts
- All seats (not adjustable) with safety belts
- Seat belts and seats cushions can be taken off and washed at max. 30°C/86°F
- Warranty: 2 years on chassis, body and wheels
- Dimensions: L 155 cm x W 75 cm x H 100 cm
Height of step : 22 cm
- Carrying capacity : 70 kg
- Product weight: 35 kg
- Shipping weight: 50 kg
- Shipping volume: 1.393 cbm



**Turtle Kiddy Bus
4-seater**

Accessories



8819003

Rain cover for Turtle 8900802

The bus must be equipped with 2 canopies at least, as the raincover is to be mounted on top of these. It provides protection for light rain as well as driving rain from the sides, however, it is not waterproof as such, as it is necessary with openings in certain places to ensure ventilation.



8900802
Turtle Kiddy Bus has no floor mat!



8831324 Canopy

Made of sun reflecting fabric. One canopy shades two seats. 67 x 30 cm, with bar 40 cm hoch.



8815624 Storage tray

Packed lunches, clothes and other items are secure in the storage tray. L 52 cm, W 35 cm, H 31 cm, weight 2,2 kg. Has room for 35 lts. Max. 10 kg.



8819095 Storage cover for 8900802

Practical rainhood that provides extra protection and keeps the Kiddy Bus dry and clean. (Only 4-seater).

Color varies!



8819054 Babyseat

(max. 2 can be mounted)
Can be placed in 2 positions. If the baby is less than 6 months, the seat can be placed in flat position (takes up 2 seats). If more than 6 months place the seat as shown. Coat covered (cotton blended fabric).

CABO[®] RUNNER



Caborunner

Driving on 2 wheels like the big ones: with the balance bike, even the youngest children will have a lot of fun! Muscle tension, body control and sense of balance are trained in a playful way and self-confidence, perception and self-assessment are promoted.

The ultralight Cabo Runner made of high-quality carbon meets all quality and safety requirements:

- Ultralight carbon balance bike 1.9 kg
- Precision material 3 mm with high corrosion resistance
- Modern and beautifully designed
- Stable sandwich construction
- Running wheels with ball bearings
- Seat bench and handlebar made of flexible birch plywood
- Handlebar stop 45 degree
- Support structure made of high-strength aluminium
- 4 different colour editions
- TÜV-certified
- For children from 2 years

- 7300500 Caborunner Black Edition
- 7300501 Caborunner Standard Custom Red
- 7300502 Caborunner Race Edition
- 7300503 Caborunner Pretty Pink Edition

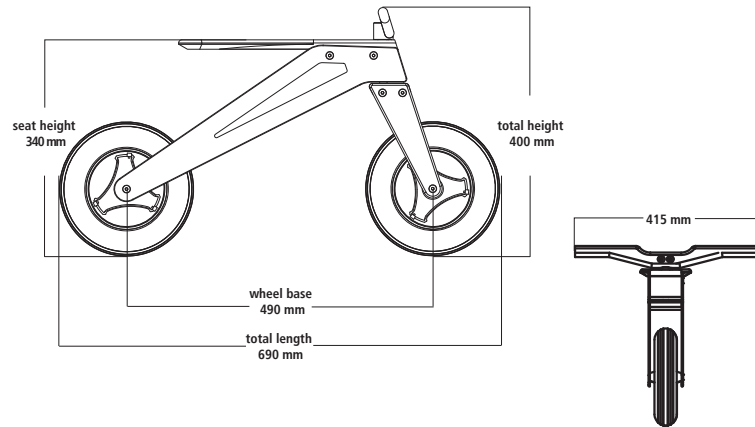

Seat bench and handlebar
made of flexible birch plywood

Frame made of ultra
light 3 mm carbon

Fork made of
ultra light
3 mm carbon

Smooth running wheels
with ball bearings

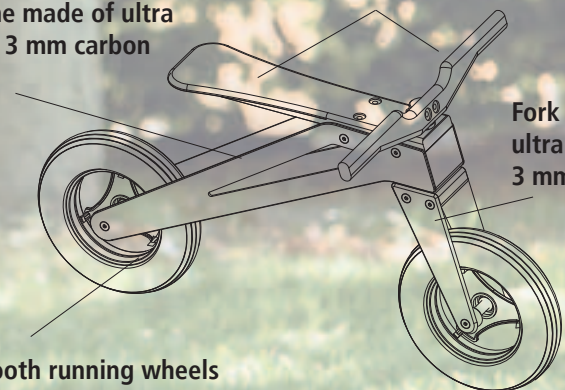



7300501 Caborunner Standard Custom Red



7300502 Caborunner Race Edition



7300503 Caborunner Pretty Pink Edition



7300500 Caborunner Black Edition



MINI VIKING

For day care facilities and crèches, families and other institutions for children, suitable for ages 1-4

CE • EN 71 • ASTM F 963

Safe design featuring rounded-off shapes and no sharp edges

anatomical seat

three tricycles with coupling to add further play value

spokeless wheels with solid rubber tyres

strong nylon bearings for both front and rear wheels

safety handlebar grips



effective rust protection and impact resistant powder coating that will last for many years

strong, non-slip pedals, solid one-piece steel crankshaft



VIDEO



- The MINI VIKING design corresponds to the age-related and motorskills of small children and promotes their development!
- safe and durable
- complies with all current safety standards

- 3 year warranty on frame and fork
- Easy to assemble
- Complete spare parts service
- Detailed spare part drawings are all available at www.jakobs.de



8600431

MINI PushBike for one

Age 1-3 years,
saddle height 24 cm, handlebar height 41 cm.
PushBike with double front wheels that provide extra support during the development and training of children's balance skills. Suitable for the very young. Propelled forward using the feet.

88600418

MINI Push car with steering wheel

Age 1-3 years, saddle height 24 cm, handlebar height 52 cm, with coupling.
New and funny push car aimed at very small children. The unique construction with a steering wheel gives good stimulation for the children and makes the imagination flourish. Imagine that a child puts himself behind the wheel and drives out into the blue in his own car or that he acts as a racing driver in his own Formula 1 car. Easy to use and accessible in its design, where the steering wheel gives good support for the very young. Like all our other vehicles the push car is characterized by supporting motor abilities, imagination, reflexes and senses of the children.

8600438

MINI Scooter

Age 1-3 years,
saddle height 24 cm, handlebar height 38 cm.
The toddler's first racer. It is not very big, but it is robust and durable. The anatomically correct design makes it comfortable to ride.

8600430

MINI Safety Scooter

Age 1-3 years,
saddle height 22 cm, handlebar height 33cm.
The er's first push a long scooter. The design with four wheels makes it stable and attractive to ride for the smallest kids. Robust and durable.



PushBike for one



1-3

43cm 54cm 24 • 41cm

4,9kg

MINI Push car with steering wheel

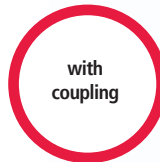

1-3

43cm 65cm 24 • 46cm

4,9kg

MINI Scooter



1-3

36cm 59cm 24 • 38cm

4,5kg

MINI Safety Scooter



1-3

36cm 55cm 22 • 33cm

4,8kg

MINI Tricycle, low

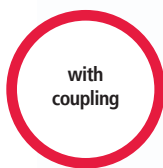

8600414

MINI Tricycle, low

Age 1-4 years, saddle height 24 cm, handlebar height 52 cm, with coupling. The development and training of children's motor skills is an aim in itself - but it should also be fun. This is a good-quality tricycle that provides children as young as 1-year-olds with lots of fun.

8600442

MINI Tricycle with foot plate

Age 2-4 years, saddle height 31 cm, handlebar height 53 cm, with coupling. This is the classic children's tricycle. This model has a foot plate and an adjustable seat. Many hours of playing await the child. The play value is great, but the possibilities increase even further if a trailer is attached.

8600447

MINI Tricycle with tray

Age 2-4 years, saddle height 33 cm, handlebar height 53 cm. It is time for the teddy bear to get out and see the world. Or the favourite doll to explore the Sahara. A very popular Winther classic with fixed-load platform.

8600436

MINI Wheelbarrow

Age 2-4 years, 5,5 kg, reinforced frame, max. load 25 kg, tray height 30 cm, L 81 cm. A wheelbarrow with two wheels so even small children can balance it. Reinforced frame and supporting feet for greater durability. Provides many opportunities for fun games.

8600437

MINI Trailer

3,6 kg, tray height 16 cm, L 60 cm, B 40 cm. It is easy to attach this trailer to models 8600413, 8600414, 8600418 and 8600442. It is ideal for transporting sand and toys as well as all kinds of other interesting things children love to cart around all over the place.

MINI Tricycle with foot plate

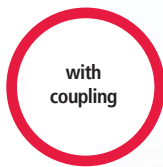

MINI Tricycle with tray



MINI Wheelbarrow

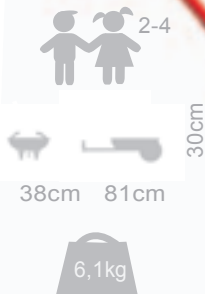

MINI Trailer



- Many different vehicles in this range help develop children's motor skills at an age when they are busy experimenting with using their bodies and finding new ways to move their bodies:
- Traditional tricycles
- Pushbikes, without pedals
- Vehicles for more children at once designed to stimulate role playing activities
- Scooters that help develop balance and coordination
- Specialized vehicles

8600413

MINI Taxi

Age 1-4, W 42 cm, L 88 cm, saddle height 25 cm, handlebar height 53 cm, weight 6,8 kg.

A trike for two children. The passenger seat encourages the driver to take his best friend for a ride on the playground.

8600411

MINI Ben Hur with pedals

Age 1-4, W 42 cm, L 74 cm, saddle height 23 cm, handlebar height 54 cm, weight 7,2 kg.

This tricycle makes it easy for more children to play together at once. Roman soldiers fighting a mighty battle with the emperor's soldiers is only one of virtually countless possibilities, stimulating their imaginations without compromising safety. Passengers standing up can hold on to the safety bar.

8600432

MINI PushBike for two

Age 1-3 years, saddle height 24 cm, handlebar height 41 cm. A push bike without pedals and with a passenger seat that encourages children's role-playing. The double front wheels make it easy to maintain balance. Equipped with a bar so the passenger can hold on during the ride.

8600439

MINI PushBike for three

Age 1-3 years, vehicle length 100 cm saddle height 24 cm, handlebar height 41 cm. Push bike with double front wheels that seat three children for role-playing.



MINI Taxi

1-4

42cm 88cm 25 • 53,5 cm

6,4 kg

MINI Ben Hur with Pedals

1-4

42cm 74cm 23 • 54 cm

7,0 kg

MINI PushBike for two

1-3

53cm 77cm 24 • 41 cm

6,5kg

MINI PushBike for three

1-3

53cm 100cm 24 • 41 cm

8,3kg

**MINI
Easy Rider**

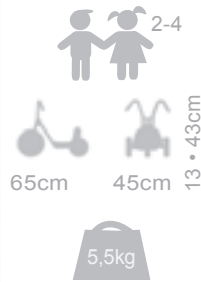

8600409

MINI Easy Rider

Age 2-4 years

Now even the youngest drivers can cruise the playground on their very own Harley Davidson. It helps the kids role play, gain independence and an "I-can-do-it" spirit.

8600433

MINI Scooter with 2 rear wheels

Age 2-4 years

handlebar height 69 cm. Black plastic platform.

A challenging scooter that helps develop children's motor skills and sense of balance. The two rear wheels provide added stability and make the scooter suitable for beginners.

8600434

MINI Scooter with 1 rear wheel

Age 3-4 years

handlebar height 69 cm. Black plastic platform.

A classic scooter that provides a good challenge for children's motor skills and sense of balance.

**MINI Twin-Wheel
Scooter**

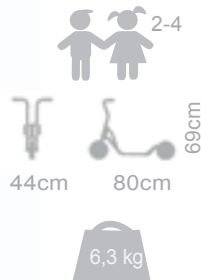

MINI Scooter

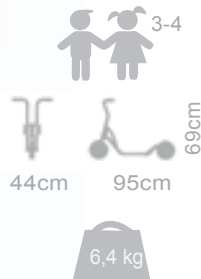

**MINI Wide-Base
Scooter**

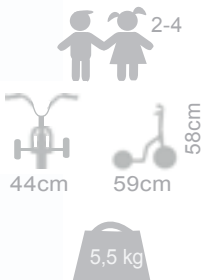

• Important!
Please use all vehicles with sturdy footwaer only!

8600412
MINI VIKING BikeRunner

Age 2,4 years, vehicle lenght 75 cm
saddle height 31 cm, handlebar height 42 cm.
The mini BikeRunner is a great opportunity for children who haven't quite got the hang of riding a bike or a scooter. This new model with its low step-through design makes it easy to get on for even very small kids. Now they can go for a ride on their own bike like the big kids. Ideal to develop their sense of balance at an early stage.

8600448
MINI Rickshaw

Age 2-4 years
saddle height 19 cm, handlebar height 45 cm,
L 98 cm, H 45 cm, weight 6,7 kg.
A rickshaw provides lots of fun for two children - with one child as a passenger, the other pulling. Comfortable seat, armrest and back support to prevent the child from falling out. A small support at the back to avoid tipping. Carrying capacity 25 kg.

8600416
MINI Sack barrow

Age 2-4 years, height 73 cm, width 41 cm, weight 5,6 kg.
The sack barrow is interesting for children. They love to move and transport things and hereby associate with adult behavior. For role-playing games the sackbarrow is also well suited.



MINI BikeRunner™



2-4
41cm 75cm 31 • 43cm

4,5kg

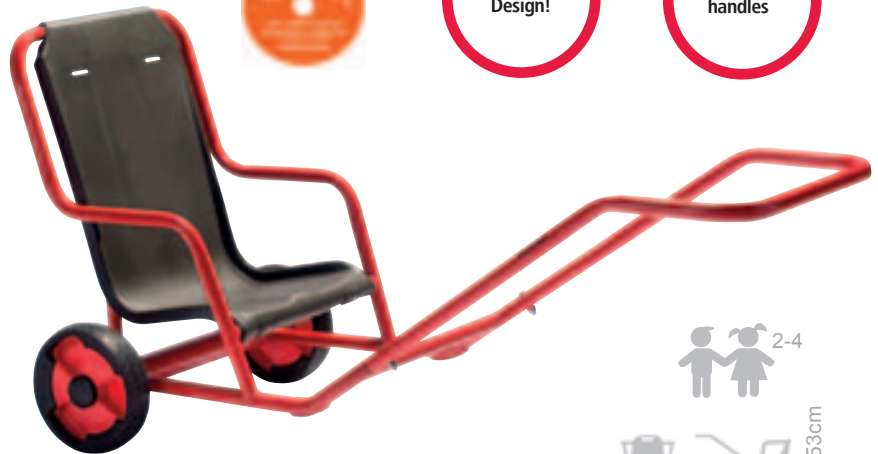

New Design!

closed handles

2-4
43cm 101cm 14 • 53cm

6,2kg

MINI Rickshaw

MINI Sack barrow



2-4
31cm 41cm 73cm

5,6kg





VIKING

For kindergartens, schools, after-school clubs and playgrounds, suitable for ages 2-12

Komplot Design



EN 71 • ASTM F963
TÜV SÜD

weather-resistant rubber seat

harmonious, safe design with no sharp edges. Strong, oval-shaped tubes ensure maximum strength

coupling to add further play value

spokeless wheels with solid rubber tyres

rubber stops to ensure children do not get fingers caught

solid rubber handlebar grips

effective rust protection and impact-resistant powder coating that will last for many years

Front and rear wheels are fitted with long-lasting industrial ball bearings

strong, non-slip pedals, solid one-piece steel crankshaft



- VIKING vehicles provide high quality, safety and long durability
- VIKING vehicles are TÜV-checked and CE and EN 71 certificated
- 5-year warranty on frame and fork
- There are many different products in this range, each designed for children with different levels of motor skills and aimed at helping them in their play and development. The wide product range gives children the best access to play activities on a scale that suits their different builds.
- Traditional tricycles

Complies with all current safety standards

- Full spare parts service
- Exploded spare part drawings are all available at www.jakobs.de
- Taxi vehicles for several children, to stimulating role-playing activities
- Scooters and bicycles developing balance and coordination
- Specialized challenging vehicles including vehicles suitable for children with disabilities
- Important! Please use all vehicles with sturdy footwear

Tricycle, small

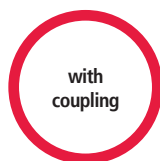
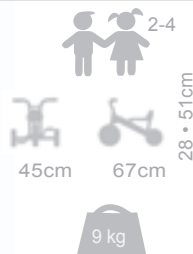

8900450

Tricycle, small

Age 2-4 years

saddle height 28 cm, handlebar height 51 cm.

To an adult it looks very simple, to a child it is a great challenge but also love at first sight. The tricycle animates children of all ages and - in the process - trains body control, coordination and develops sense of space.

8900451

Tricycle, medium

Age 3-6 years

saddle height 35 cm, handlebar height 62 cm.

This tricycle is a WINther classic. Million of children have proved its worth. All tricycles can be used with a trailer, which makes them even more fun to play with.

Tricycle, medium

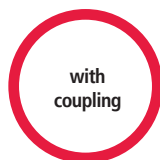

8900452

Tricycle, large

Age 4-8 years

saddle height 43cm, handlebar height 69 cm.

This tricycle is equipped with a large front wheel, which allows slightly older children to really use their strength. With a trailer attached it immediately becomes an amazing team for imaginative play.

8900469

Tricart

Age 4-12 years

saddle height 26cm, handlebar height 70 cm.

An exciting alternative to the classic tricycle. The adjustable seat means the Tricart can be used by children of many different ages.

8900479

Easy Rider

Age 4-7 years

saddle height 15 cm, handlebar height 63 cm.

It is red and it is very cool! It has a low seat and a Harley-type handlebar. The large front wheel lets children work up a good speed and maintain momentum.

Tricycle, large

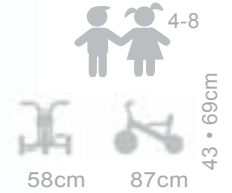

13,0kg

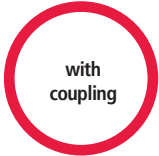

Tricart

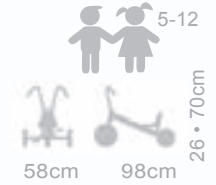

12,5kg

Easy Rider

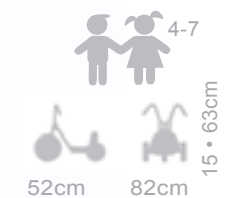

10,2kg

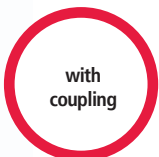

Taxi

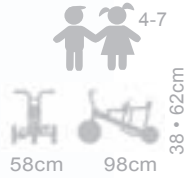

8900462

Taxi

Age 4-7 years
saddle height 38 cm, handlebar height 62 cm.
Extremely popular, strong taxi is ideal for use in all kinds of role-playing games. A safety bar is good for children to hold on to, and makes children feel secure. Attaching a trailer provides even more possibilities for playing advanced games.

8900468

Twin Taxi

Age 4-7 years
saddle height 38 cm, handlebar height 62 cm.
Children often use play to imitate adults or situations they have experienced in their day-to-day lives. This kind of play activity is often called role-playing. The Twin Taxi stimulates the imagination - the possibilities are endless. Has room for three children.

8900465

Ben Hur Tricycle

Age 4-7 years
saddle height 38 cm, handlebar height 62 cm.
This tricycle makes it easy for more children to play together at once. Passengers standing up can hold on to the safety bar. This results in countless possibilities and imaginations. As always, attaching a trailer can make even more fun play with.

8900466

Ben Hur Trailer

L 84 cm, W 58 cm.
Versatile trailer for all VIKING tricycles and taxis with coupling. Equipped with safety bar and slip-proof foot plate. Ideal for childrens' games that take place in the past, the present and the future. Has Ben Hur ever been to the Moon? No doubt - in a play universe near you.

Twin Taxi

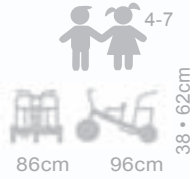

Ben Hur tricycle



Ben Hur trailer

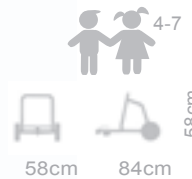
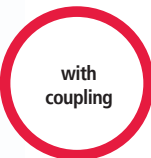

8900496
VIKING Kangaroo

Age 4-7 years
saddle height 52 cm, handlebar height 66 cm.
With this fun trike the child can bring out deliveries in the form of sand, toys, - anything really - to friends all over the playground. The trike has a striking resemblance with a cargo bike and unlike the traditional delivery bike it has a real box in front.

8900493
VIKING Truck

Age 4-7 years
saddle height 37 cm, handlebar height 68 cm.
New and funny truck which strengthens the social play and gives vent to the childrens' imagination. The cargo enables the children to do transport of sand or playground equipment in general. Imagine the child in the role as a truck driver or «Bob the Builder» on his way to the building site. In this way the truck becomes an important element in the mutual play among the children. The truck is constructed in a beautiful and harmonious design in which all safety aspects have been observed.

8900497
VIKING RowKart

Age 4-8 years
saddle height 29 cm, handlebar height 58 cm.
This fun inspection trolley will be the star of the playground. To really get things going, children need a good sense of rhythm as they pull and push the handles for forward motion and steer with their feet. It is excellent fun and excellent for strengthening motor and coordination skills.

8900498
VIKING FunCart

Age 3-6 years
saddle height 21 cm, handlebar height 48 cm.
Cool driving characteristics making it exciting to ride. Gives lots of fun with thrills and stimulation of the FunCart goes very smooth by using the two handle pins making the rear wheels move. Improves children's coordination skills as the child uses the entire body when driving.



VIKING Kangaroo



4-7
58cm 105cm 52 • 66cm
18,5kg

VIKING Truck

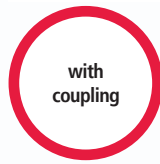

4-7
52cm 103cm 37 • 62cm
17 kg

VIKING RowKart™



4-8
61cm 91cm 29 • 58cm
17,3kg



VIKING FunCart™



4-7
55cm 70cm 21 • 48cm
11,4kg





Bicycle

Bicycle, large



4-7
45cm 82cm 42 • 65cm
10,5 kg

6-10
45cm 96cm 48 • 77cm
13 kg

8900474

Bicycle

Age 4-7 years, saddle height 42 cm, handlebar height 65 cm. Once children have mastered the two-wheeler they have reached another milestone in the development of their motor skills. Their legs, arms, eyes and brain have to work together to keep their balance. This may sound difficult, but it's actually child's play. As long as they have the right things to play with.

8900491

Bicycle, large

Age 4-8 years, saddle height 48 cm, handlebar height 77 cm. This speedy two-wheeler is similar to model 8900474. It is just as fun, just a stimulating only slightly bigger.

8919255

Winther Bike Helmet

Children's safety helmet with size adjustment and adjustable chin strap with safety closure. Children must not use this helmet when climbing or during other activities where there is a danger of strangulation.

8900463

Rickshaw

Age 4-12 years saddle height 34 cm, L 136 cm, W 57 cm. Lots of fun for two - with one child as passenger, the other pulling. Seat with back support and safety bar, slip-proof aluminium foot plate and a small wheel that ensures that the rickshaw does not tip up.



Bike Helmet



Rickshaw



4-12
57cm 136cm 34cm
15,1kg

8900477

Wheelbarrow

Age 3-7 years L 82 cm, width 39 cm, height 44 cm, max. load 50 kg. Sturdy frame standing in its own base. The body is reinforced and protected by the frame to withstand rough treatment. Even the legs are reinforced to avoid wear. Solid wheel with industrial ball bearing. The adult way of handling the wheelbarrow trains children's sense of equilibrium.

8900476

Trailer

Carrying capacity 75 kg, L 87 cm, W 52 cm. Robust, stable multi-functional trailer that can be used with all Winther heavy duty tricycles and taxis. Slip-proof bottom, and easy and simple to attach. Provides lots of different play opportunities, including transport sand, toys, passengers and much more.





Wheelbarrow



3-7
82cm 39cm 44cm
7,8kg

Trailer





11,5kg 52cm 87cm 27cm

8900495

Scooter, maxi

Age 8-12 years, footbrake, handlebar height 93 cm, extra reinforced platform.

A challenging and fun scooter, which is similar to model 8900460 and 8900467 but, aimed at slightly bigger children. Rest assure the wheels of this scooter will never stop turning as long as there are children on the playground.

8900460

Scooter, small

Age 4-5 years, footbrake, handlebar height 76 cm, extra reinforced platform.

Mastering a scooter gives children a tremendous sense of achievement. First it was the tricycle. «Now I have grown up. I can balance.» It gives heaps of confidence and trains efficiently balance and coordination

8900467

Scooter, large

Age 6-10 years, footbrake, handlebar height 86cm, extra reinforced platform. Well-suited for older and slightly bigger children.

8900475

Safety Scooter™

Age 4-7 years, handlebar height 76 cm, scooter with 3 wheels.

Well-suited for children, who need to strenghten their balance and motor skills as well as for children with reduced capabilities. The Safety Roller provides maximum stability.

8900490

BikeRunner™ small

Age 2-4 years, saddle height 35 cm, handlebar height 52 cm. BikeRunner is a small runnerbike with optimal dimensions for small children. This helps children develop their sense of balance before they start riding a proper scooter or bicycle.

8900486

BikeRunner™ large

Age 4-7 years, saddle height 42 cm, handlebar height 65 cm. The ideal play vehicle for children not yet ready for a scooter or bicycle. Provides a fun way of developing a good sense of balance. Children's feet can always have contact to the ground - for propelling and supporting.

8900487

Tandem BikeRunner™

Age 4-7 years, saddle height 42 cm, handlebar height 65 cm. Now children's games become even more exciting and fun. In addition to coordinating their own movements, children also have to work to coordinate these with those of their passenger. It's lots of fun and gives them plenty of opportunities to practise their balance and coordination.



Scooter, small

Age 4-6 / 6-10

47cm | 100cm

76cm | 86cm

8,6kg | 8,8kg

Scooter, maxi

Age 8-12

47cm | 123cm

93cm

10,6kg

Safety Roller™

Age 4-7

50cm | 88cm

76cm

8,6kg

BikeRunner™ small

Age 4-7

45cm | 71cm

42 • 65cm

10 kg

7,3kg

BikeRunner™ large

Age 3-5

44cm | 71cm

35 • 52cm

Tandem BikeRunner™

Age 4-7

47cm | 105cm

42 • 65cm

11,9kg

Swingcart™ small

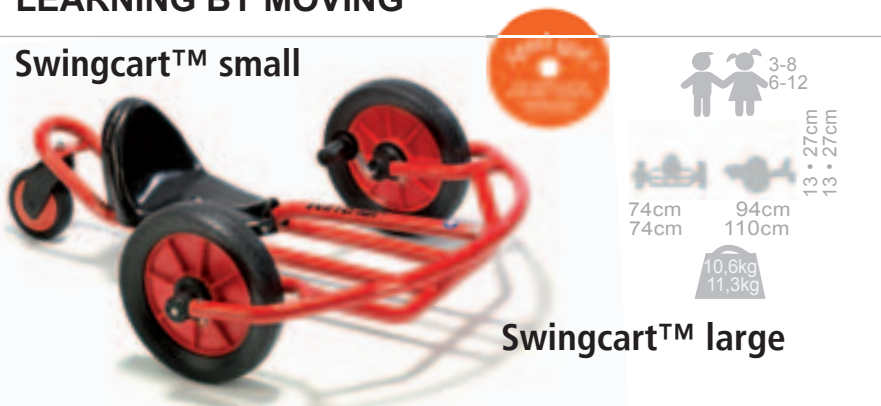

Swingcart™ large



Larger swivel wheel for better driving performance



8900464

Swingcart™ small

Age 3-8 years, saddle height 13 cm, W 74 cm, L 94 cm. An unconventional way to develop children's coordination skills. Children can turn the pedals using their arms, which makes this Swingcart ideal for those unable to turn the pedals on a conventional bicycle or tricycle. The larger swivel wheel improves high driving performance. Strengthens arms and chest.

8900470

Swingcart™ large

Age 6-12 years, saddle height 13 cm, W 74 cm, L 110 cm. All children need challenges to help develop their motor skills. Children with different motor skills problems require special attention. The Swingcart is fun for everyone. Children turn the pedals using their arms, which makes it ideal for children with reduced capabilities in their legs.

8939138

Wall Rack

Wall-mounted rack for Winther vehicles L 23 cm, D 8 cm, rackholder L 30 cm The wall-mounted rack is of the usual high Winther quality and for Winther scooter and bikes. This special rack saves lots of floor space. The front wheel is placed in the rack. It's easy to use and helps make sure that two-wheelers are kept well out of the way.

8939139

Cycle Rack

Cycle rack for 3 scooters or two-wheelers L 66 cm, D 20/33 cm, H 23 cm. Versatile rack for 3 scooters and two-wheelers that keeps them tidy and well-ordered, in addition to saving space. Should not be mounted anywhere near children's play areas.

8900951

Original PlasmaCar

Age 3+. For maximum load of 55 kg outside and 100 kg inside, saddle height 21cm, handlebar height 41cm, L 79cm, B 35cm. PlasmaCar is a unique vehicle that provides a lot of fun, due to the surprising different way it moves. To propel PlasmaCar forward just turn the steering wheel back and forth continuously, to go in reserve, rotate the steering wheel 180 degrees. Children put their feet on the footrest, lean slightly forward, grip the steering wheel and use their seemingly limitless energy as driving power. To stop the PlasmaCar just put the feet on the ground. To be used on even, smooth surfaces, inside or outside - not to be used on wooden floors. For kindergartens, day care facilities and creches. PlasmaCar meets European and American toy safety standards. Stable, high-quality ABS-plastic, 6 wheels, delivery not assembled, incl. assembly instructions. Comes unassembled.

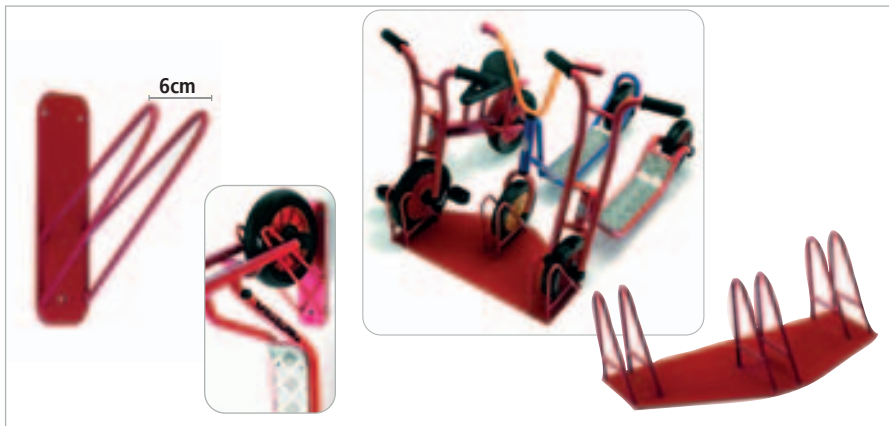

Original PlasmaCar

for self-assembly

3+
35cm 79cm 21 • 41cm

4,9kg

VIDEO



VIKING CHALLENGE

For kindergartens, schools and playgrounds, suitable for ages 2 and up



Strong powder coated steel tubes

Anatomically correct shaped seat

Strong ball bearing

for the best ride possible use only on hard surfaces, avoid grass or gravel

reinforced front tube to avoid wear



double front wheels -long term durability



- Challenge is Winther's range of special vehicles, which provide particular challenge, excited play and serious amounts of play value.
- Suitable for ages 4 and up.
- 3-year warranty on frame
- complies with current safety standards
- fully assembled on delivery
- full spare part service
- exploded spare part drawings are all available at www.jakobs.de



8500620

CHALLENGE Foot Twister

Age 4-6 years,
W 45 cm, L 72 cm, H 32 cm, weight 6,5 kg.
Foot Twister is a fun, challenging, and innovative vehicle that is propelled forward by the zigzag motion of eager children's feet. To get a smooth ride it takes equal amounts of rhythm, technique and upper-body coordination. It is a challenge but most of all it is great fun.

8500621

CHALLENGE Foot Twister Large

Age 6-10 years,
W 46 cm, L 80 cm, H 33 cm, weight 7 kg.
The successful vehicle-model Foot Twister is also available in the version «Large» for older and bigger children. The large model has the same features as the small model (see above).

Foot Twister™

72cm
80cm

45cm
46cm

6.5kg
7 kg

32cm
33cm

Foot Twister Large™



Hand Twister™



8500622

CHALLENGE Hand Twister

Age 4-6 years,
W 45 cm, L 72 cm, H 44 cm.
This model is suitable for younger and smaller children.
The features are the same as Hand Twister Large.

8500623

CHALLENGE Hand Twister Large

Age 6-10 years,
W 46 cm, L 88 cm, H 44 cm.
The large Hand Twister is suitable for older and bigger children and has the same features as the more smaller model. Children use their hands not their legs for forward motion. Equal amounts of rhythm, technique and upper-body coordination are required for a smooth ride, and it is still heaps of fun.

8500626

CHALLENGE CircleBike

Age 4-6 years,
W 100 cm, H 52 cm, seat height 34 cm, diameter holding ring 37 cm, weight 6,5 kg.
A funny carousel that challenges the children's ability to coordinate, as the wheels can take them in any direction. The vehicle provides for numerous plays of social character, as the children can chat and interact in many ways, while being seated face to face. Designed by Tukan Design. Load capacity 75 kg.

8500625

CHALLENGE Digger

Age 4-10 years
Saddle high 38 cm, W 70 cm, L 150 cm, weight 11,9 kg.
This fun digger is a true classic. It moves bucket loads of sand in no time and turns every sandbox into a construction site. At the same time it encourages role-play, stimulates the imagination, and strengthens right-left hand coordination.

Hand Twister Large™



available again



CircleBike

Comes fully assembled

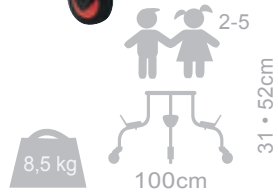

Digger

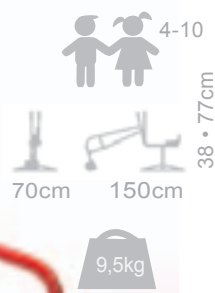



CHALLENGE Walkabout

The Winther Walkabout is a brilliant walking/push trike for toddlers, who haven't been on a bike before. It is easy to access and to get started, without any pedals that require training skills for the child. With a steer that is easy to manoeuvre, the children start off walking or pushing themselves forward instantly and smoothly. This makes it ideal for the transition phase between walking and pedaling. A perfect way for the children to gain balancing ability and confidence at the same time, when they learn to master their first riding technique.

Comfortable seat and nice and unique design, which is sturdy and safe at the same time. Non-toxic finishes and child safe materials. Perfect to use with a friend who is pushing the trike.

8500631
CHALLENGE Walkabout

8500632
CHALLENGE Walkabout Duo

8500629
CHALLENGE WheelyRider

Age 4-10 years, saddle height 40 cm, height 63,5 cm, length 89cm, width 89cm, Weight 19,9 kg.
An unconventional new vehicle that can rotate and move back and forth. Develops children's coordination skills and broadens their understanding for others with disabilities.

8500630
CHALLENGE Petrol Station

Age 3+, height 71cm, length 50cm, width 32cm, Weight 14,4kg.
Anyone in need of petrol, water or oil? The petrol station invites the kids to use their imagination, helps them role play and lets everyone feel part of a community.

Material: sheet steel powder coated

2-4
47cm 57cm 26cm 43cm
4,4 kg

Comes fully assembled

2-4
47cm 77cm 26cm 43cm
5,7 kg

WheelyRider

Comes fully assembled

19,9kg

4-10
89cm 89cm 40 • 63,5cm

Indoor & Outdoor

14,4kg

3+
50cm 32cm 71cm



Specialized wheeled toys for after school clubs and playground. Suitable for ages 3-12.

Effective rust protection and impact-resistant powder coating, that will last for many years.

anatomically shaped seat.

Solid rubber handlebar grips.

Pelikan Design



EN 71
TÜV SÜD



Strong front wheel fitted with long-lasting industrial ball bearings and rubber tyre.

Steering rod between front fork and rear axle gives excellent driving characteristics. Small turning radius

Strong non-slip pedal



5-12

54 • 91cm

44cm 101cm

10,5kg

Penny Farthing

solid
puncture free
front tire

8900481

EXPLORER Penny Farthing

Age 5-12 years, 9 kg, solid puncture free front tyre, PE saddle height 54 cm, handlebar height 91 cm.

Amusing special cycle that is a major challenge for balance and coordination skills. Solid front tyre made of PE and solid rear wheel. Long seat that makes this special design fun for children of many ages.

8400482

EXPLORER Penny Farthing Small

Age 4-7 years, solid puncture free front tyre, saddle height 45 cm, handlebar height 75 cm, weight 8,7 kg.

Amusing special cycle that is a major challenge for balance and coordination skills. Solid front tyre. Long seat that makes this special design fun for children of many ages.

4-7

45 • 75cm

48cm 90cm

8,7kg

Penny Farthing Small

solid
puncture free
front tire



8900480

EXPLORER FunRacer

Age 4-12 years, saddle height 26 cm, height 62 cm, length 98cm, width 68cm.

Lots of fun for children with speed, thrills and stimulation. Also helps develop both their coordination and their ability to manoeuvre. Now with puncture resistance PU tires at the front and at the back.

8900484

EXPLORER U-Rider

Age 6-10 years, weight 17,4 kg, puncture resistance PU wheels, seat height 27cm, W 58cm, L 125cm.

A great item for after school facilities.

Any child's dream is to drive such a cool vehicle, built in a futuristic design Stimulates brain activity - in both the right and the left hemispheres. Steering is done by a combination of handles and body weight. Cool driving characteristics enabling the child to go both forwards and backwards.

8400488

EXPLORER BobKart

Viking BobKart is a true classic on the playground.

With a function like a soapbox car it invites the children to social games like a Go-Kart race.

Pedals are footrest only. Both small and large kids find this trike very funny and challenging.

8900487

EXPLORER FunCart Large

Age 6-10 years, saddle height 32 cm, handlebar height 67 cm.

Cool driving characteristics making it exciting to ride. Gives lots of fun with thrills and stimulation of the FunCart goes very smooth by using the two handle pins making the rear wheels move. Improves children's coordination skills as the child uses the entire body when driving.



FunRacer™

- adjustable seat
- solid puncture free front and back tires
- with coupling

4-12
68cm • 98cm
26 • 62cm
20,8kg



U-Rider

- improved with closed rear wheels
- Comes fully assembled

6-10
76cm • 125cm
27 • 58cm
18,8kg



BobKart

67cm • 121cm • 18 • 67 cm
4-10
20 kg

Pedals are fixed and serve as footrests.



FunCart™ Large

- Comes fully assembled
- with coupling

6-10
64,5cm • 90cm
32 • 67cm
20,6kg



Zlalom Tricycle™

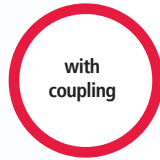

8400661

EXPLORER Zlalom Tricycle

Age 4-7 years, seat height 23cm, W 58,5cm, L 86cm.
The model for younger and smaller children has the same features as the larger model.

8400662

EXPLORER Zlalom Tricycle Large

Age 6-10 years, seat height 24cm, W 58cm, L 95cm.
Cool slalom driving characteristics which makes it exciting to ride. Requires only very little space to make a turn and may even be able to make sharp curves without tipping over. With its broad and rough tires it may appeal to especially boys who like challenges. Unique steering capabilities that have been patented.

8445174

VIKING OFF-Road Tricycle, medium

Age 3-6 years
saddle height 35 cm, handlebar height 62 cm.
Cool looking Viking Off-Road Tricycle, Medium, with broad and rough tyres that are ideal for uneven surfaces. This trike have a special appeal to children who like challenges and want to set their imagination free

Zlalom Tricycle Large™

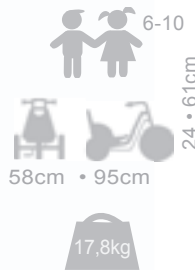
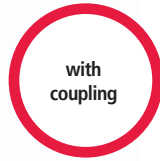

8445274

VIKING OFF-ROAD Tricycle, large

Age 4-8 years
saddle height 43 cm, handlebar height 69 cm.
Cool looking Viking Off-Road Tricycle, Large, with broad and rough tyres that are ideal for uneven surfaces. This trike may inspire older children to play a little longer.

OFF-ROAD Tricycle, medium

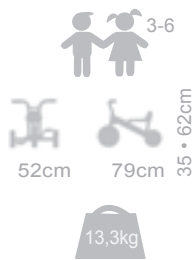
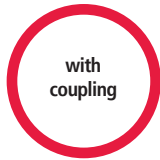

OFF-ROAD Tricycle, large

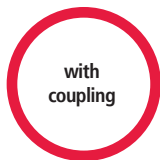

8446974

VIKING OFF-ROAD Tricycle, maxi

Age 5 -12 years

saddle height 31 cm, handlebar height 74 cm.

An exciting alternative to the classic tricycle. Built for off-road adventures and uneven surfaces. The adjustable seat makes it suitable for children of many different ages.

8447974

VIKING OFF-ROAD Easy Rider

Age 4 -7 years

saddle height 15 cm, handlebar height 63 cm.

Viking Off-Road Easy Rider with broad and rough tyres that are ideal also for uneven surfaces. This trike may have a special appeal to children who like challenges, e.g. by playing that they are in a rally or a desert race.

8900598

VIKING EXPLORER StarScooter maxi Chrom

Age 4-12 years, footbreak and puncture resistance PU tyres, handlebar height 93cm, W 47, L 123cm, weight 10,6 kg.

A true classic on the playground now appearing in a new streamlined design. A fun scooter which is loved by all children. Challenges every child's sense of coordination and balance.

OFF-ROAD Tricycle, maxi



31 • 74cm

OFF-ROAD Easy Rider

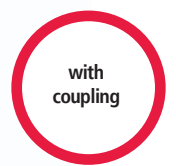

15 • 63cm



StarScooter™ maxi chrom





Dolphin



WINTHER Dolphin bike trailer

Enhancing well-known Dolphin bike trailer and baby buggy by Winther offers optimized safety, additional comfort and improved riding conditions. Small on the outside, big on the inside.

A headroom of 70cm means there is enough room for larger children as well. Despite its generous internal space the Dolphin is the narrowest 2-seater child cycle trailer in its class with a total width of less than 80cm. This narrow width is a big advantage especially when the trailer is used as a buggy, for instance in a lift or an elevator.

Further benefits:

- side windows can be opened and thus internal space is ventilated optimally
- yellow rear can easily be seen in traffic
- adjustable, stable backrest
- spacious stowage space behind backrest
- seats and belts have a soft padding and are hand-washable
- the new, flexible 5-point safety harness allows strapping easily one child in the center or children beside each other
- converting the cycle trailer to a buggy is made very fast and easily

8985180 Dolphin New Edition- red

8985184 Dolphin New Edition- black

Weight 13,3 kg, max. load 50 kg, extensions 162 cm x 79 cm x 103 cm, folded 101cm x79 cm x 39 cm, headroom 70 cm.

8985170 Dolphin XL-red

8985174 Dolphin XL-black

Weight 13,3 kg, max. load 50 kg, extensions 162 cm x 79 cm x 103 cm, folded 101cm x79 cm x 39 cm, headroom 75 cm.

The Dolphin comes with a safety flag, tow bar and Weber adapter.

For further information please visit www.jakobs.de/Dolphin-und-Donkey/

Donkey



WINTHER Donkey Cargo-trailer

The small and practical trailer!

If you need a trunk for your bicycle, the Donkey is what you are looking for. It can easily be trailed to your bicycle and can be taken for shopping along. The Donkey is delivered without clutch - optionally available are a Winther universal clutch, a Pletscher clutch and a Weber M-coupling for E-bikes.

8985000 Donkey Classic (schwarzer Rahmen, rote Plane)

8985015 Donkey Classic (schwarzer Rahmen, schwarze Plane)

Weight: 10.50 kg, max.load 40 kg, capacity box: 65 litres, dimensions: 61x100 cm.

For further information please visit www.jakobs.de/Dolphin-und-Donkey/

The Jaalinus line is a proprietary Jakobs brand and has been developed in partnership with Winther. Jaalinus is designed for the worldwide sales - it is a good alternative, produced in solid, stable quality and modern design.

- Our range of vehicles JAALINUS® is designed for children between the age of 2 and 8 years: in kindergartens, in crèches, for daycare facilities and on playgrounds
- Solid-founded quality features
- Well-balanced design
- Tricycles, Taxi, BikeRunner, Scooter and Firetruck have been developed especially for use in the range of motion and activity
- Each model meets all current safety standards
- JAALINUS vehicles are TÜV-checked, EN71- and CE-certificated
- 3-year warranty on frame and fork, 1 year warranty on spare parts.
- Complete spare parts service
- Detailed spare part drawings available at www.jakobs.de or at www.jaalinus.de (360° degree view)



www.jaalinus.com



CE • EN 71 • TÜV • ASTM F 963

modern, rounded design without sharp edges

seat made of weather resistant polyethylene

strong heavy duty tubes for high demands

spokeless wheels made of durable polypropylene-material



solid rubber handlebar grips

built-in steering limiter - no pinch points

pedals made of durable polypropylene-material

strong nylon bearings for all wheels

**7400645
JAALINUS Firetruck**

It's burning and the fire service is informed! There is a close arrival with the Firetruck and two «firemen» can help immediately. All children will love this attractive vehicle! The Firetruck will rapidly become the centre of many exciting roleplays and the focus of fancy and imaginative play-situations.

JAALINUS® Firetruck



4-8
34 • 61cm
59cm • 101cm
14,8kg

JAALINUS® Pushbike



2-4
27 • 51cm
45cm • 68cm
6,5kg

**7400650
JAALINUS Pushbike**

This pushbike for the very small ones is the first invitation and demand to ride and steer a vehicle autonomously and gives small children the feeling of success when moving and riding. With both feet always on the ground each child - according to its capabilities - can try first successful test drives in a safe and stable way while motor skills, balance and coordination can be developed in a playful way.



JAALINUS® Tricycle small



2-4
28 • 54cm
45cm • 68cm
6,9kg

**7400640
JAALINUS Tricycle small**

Riding a tricycle is an unique experience and great challenge for small children. Complex movement processes, motor skills and coordination are being trained in a playful way. Movement is being actively implemented and provides new space perception. Children learn to determine speed and direction, they have to decide either to drive ahead or round bends.

JAALINUS® Tricycle medium



3-6
35 • 60cm
52cm • 79cm
8,1kg

**7400641
JAALINUS Tricycle medium**

The classic tricycle for bigger and/or older children. To drive a tricycle is not only a basic experience in the field of motor skills and active games, but the tricycle is also the great love of all children – over many years! In many attractive games and roleplays children learn and develop a lot of important social and emotional aspects and structures.



**7400649
JAALINUS Bike Runner**

By «cycling» a bike runner a further step in the development of motor skills is being tested and trained. It is a special challenge and perhaps a kind of wobbly experience at the beginning. But children learn quickly how to keep balance and to control their movements and then rush round corners, slow down, break and go on – almost like the grown-ups on bikes.

**7400646
JAALINUS Scooter**

After riding a tricycle riding a scooter is a new experience and challenge for children. Balance capabilities, reaction and coordination are being trained and developed in a playful way. With the scooter children explore their environment from a new perspective: they ride fast or even slow, they steer, they circle, they slow down, they stop.



3-6
45cm • 81cm
34 • 60cm
5,7kg

JAALINUS® BikeRunner™

3-5
45cm • 101cm
76cm
6,3kg

JAALINUS® Scooter

**7400644
JAALINUS Taxi**

To drive with this great taxi provides lots of fun for all children and encourages interactive and communicative play and cooperation in a group. Playing figures and scenes based on real-world or to create and play own imaginations – together with other children and friends – is always exciting, fascinating and funny.



3-7
63cm • 110cm
36 • 60cm
10,7kg

JAALINUS® Taxi

Jakobs aktiv

For Kindergartens, Nurseries, Daycare Facilities and Playgrounds.
Suitable for Ages 2 - 8.

The Jakobs aktiv line is part of the Winther program - it is a good alternative and combines stable, solid quality with an appealing design and comes with a wide variety of models in attractive colour.

CE • EN 71 • ASTM F 963

anatomic seat made of weather-resistant polyethylene

strong heavy duty tubes ensure maximum strength



pedals and spokeless wheels made of polypropylen with solid rubber

solid rubber handlebar grips

no pinch point built-in steering limiter

industrial ball bearings for all wheels

attractive new design with no sharp edges



VIDEO



Easy Rider aktiv

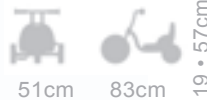

with coupling

- Jakobs aktiv - attractive, modern design and heavy duty quality complying all current safety standards on the market.
- Line of trikes, bicycles and scooters and specialized vehicles
- 3 year warranty on frame and fork
- 1 year warranty on components
- sturdy nylon bearing
- complete spare parts service

7500553

Easy Rider aktiv

age 4-7 • saddle height 19 cm, handelbar heighth 57 cm

This is a cool vehicle! Who will be the first on the playground to capture this great trike? You can easily imagine driving a Harley-Davidson or a Formula 1 racing car.



7500550

Tricycle aktiv «S»

age 2-4 • saddle height 24 cm, handlebar height 51 cm
The classic tricycle in a brand new design. Every child loves the freedom to get around on this trike. It is easy to move forward, trains the muscles and develops motor skills.

7500551

Tricycle aktiv «M»

age 3-6 • saddle height 27 cm, handlebar height 60 cm
A very popular, robust tricycle, suitable for most children. A tricycle is a must on every playground. It stimulates the play of children and develops children's motor skills.

7500552

Tricycle aktiv «L»

age 4-8 • saddle height 41 cm, handlebar height 71 cm
This tricycle is designed with a large front wheel enabling children up to 8 years of age to have fun on the playground. The keen children will love to drive around on this trike!

7500570

Trailer aktiv

W 58 cm, L 72 cm, weight 9 kg.
Cool and stable trailer designed to serve many purposes: Invites the children to participate in roleplaying by transporting sand to the construction site or toys from the sandbox. Easy and simple to attach.

Tricycle aktiv «S»

with coupling



2-4

45cm 68cm 27 • 51cm

8,0kg

Tricycle aktiv «M»

with coupling



3-6

52cm 79cm 34 • 60cm

9,5kg

Tricycle aktiv «L»

with coupling



4-8

58cm 92cm 41 • 71cm

10,5kg

Trailer aktiv

with coupling



58cm 72cm 22cm

9.0kg



Pushbike aktiv

2-4

45cm 68cm 27 • 51cm

7,0kg

with coupling



BikeRunner™ aktiv

3-5

45cm 81cm 34 • 60cm

7,0kg

BikeRunner™ large aktiv

4-7

45cm 98cm 42 • 71cm

8,5kg

Bicycle aktiv

3-6

45cm 81cm 34 • 60cm

7,5kg



7500560

Pushbike aktiv

age 2-4 • saddle height 27 cm, handlebar height 51 cm
Two rear wheels and pedals make the Pushbike very stable and easy for children to maintain their balance while moving. A good start before driving a tricycle or bicycle.

7500559

BikeRunner™ aktiv

age 3-6 • saddle height 34 cm, handlebar height 60 cm
The BikeRunner is the perfect choice when learning the children to develop their sense of balance. The bike is pushed forward by using the feet.

7500566

BikeRunner™ large aktiv

age 4-7 • saddle height 42 cm, handlebar height 72 cm
This cool BikeRunner is similar to model 7500559 only slightly bigger. But it is still the perfect choice when helping children develop their sense of balance. And it is still lots of fun.

7500558

Bicycle aktiv

age 3-6 • saddle height 34 cm, handlebar height 60 cm
When riding the bicycle the children have reached the ultimate freedom to explore the world. They can easily get around and use their motor skills like an adult.



7500573

Scooter large aktiv

age 4-6 • handelbar heighth 86 cm • with brake
Scooter large aktiv in a larger size for lots of fun for older and bigger children.

7500556

Scooter aktiv

age 3-5 • handelbar heighth 76 cm
The scooter challenges the children's sense of coordination and balance. After driving on a tricycle it is a new world to scoot around on two wheels! Lots of fun for everyone!

7500557

Safety Scooter aktiv

age 3-7 • handelbar heighth 76 cm
This fun Safety Roller provides maximum stability. This makes it ideal for children, who need to develop their balance and motor skills, as well as for children with reduced capabilities.

7500571

Push Wagon aktiv

W 50 cm • L 64 cm • handlebar height 62 cm
This wagon with its sturdy box will give the children a lot of play value. The child may bring out deliveries in the form of sand or toys to their friends all over the playground. It encourages imagination and roleplay, as more children can take part in the game.

Push Wagon aktiv



Scooter large aktiv

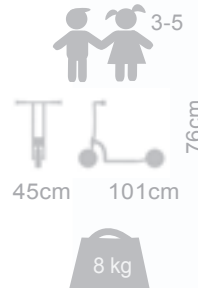
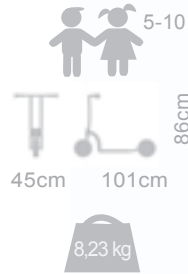

Scooter aktiv



Safety Scooter aktiv





Taxi aktiv



7500554

Taxi aktiv

age 3-7 • saddle height 35 cm, handlebar height 60 cm
A taxi is lots of fun and provides many great play ideas. The children love the role-playing games bringing extra features and imagination into their play with their friends

7500561

Truck aktiv

age 4-7 • saddle height 34 cm, handlebar height 61 cm
Let's get some work done or how a about taking one's best friend for a ride. No matter what the children are guaranteed lots of fun and social play on the playground.

7500572

Rickshaw aktiv

age 2-12 Jahre • saddle height 22 cm • height 59 cm
A Rickshaw provides a lots of fun for two children – with one child as passenger, the other pulling. Security bar at the back to provide kipping.

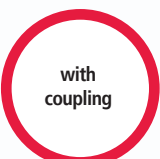
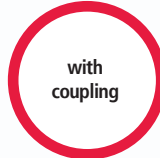

Truck aktiv



Rickshaw aktiv

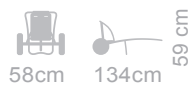

NEU

7501555

Twin Taxi aktiv

age 4-7 • saddle height 35 cm, handlebar height 63,5 cm
A taxi for three children that opens up for many social games and role playing activities. The child may take his best friends for a ride, acting as a driver, while his friends are chatting in the back. Cool and sturdy design!

7501562

Tricycle Police aktiv

age 4-7 • saddle height 34 cm, handlebar height 61 cm
All bad guys better watch out! The police is here. This cool trike quickly becomes the natural centre for social activities on the playground. The extra colour «Blue» increases the special play value of this trike.

7500571

Push Wagon aktiv

W 50 cm • L 64 cm • handlebar height 62 cm
This wagon with its sturdy box will give the children a lot of play value. The child may bring out deliveries in the form of sand or toys to their friends all over the playground. It encourages imagination and roleplay, as more children can take part in the game.

Twin Taxi aktiv

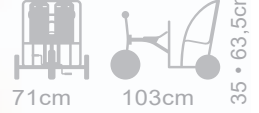

NEU

New spokeless wheels made of polypropylene with solid rubber

Tricycle Police aktiv



Stroller aktiv

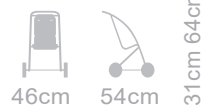

Since 1966, GONGE products have inspired and motivated children to be physically active, while helping them learn and develop in creative ways. GONGE is committed to "play as the mechanism for learning", and continue to develop products that stimulate children's physical, cognitive, social and emotional development without compromising on fun.

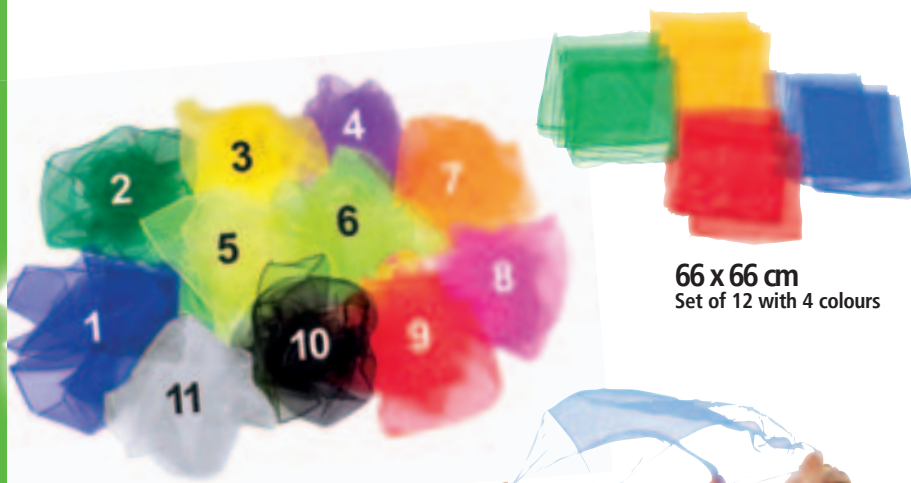

66 x 66 cm
Set of 12 with 4 colours

65 x 65 cm
Pack of 12 in one colour



Magic Scarves



Set of 4
138 x 138 cm



Parachutes



Magic Scarves

Colour-intensive Magic scarves made of lightweight nylon that fall extra slowly and beautifully - for swinging, throwing, catching, playing and shaping. Universal and versatile for all play and movement areas, (children's) gymnastics, senior gymnastics, rehabilitation, therapy and of course for balance and juggling training.

1911500

Set of 12 Magic Scarves 66 x 66, chiffon
Set of 12, in 4 colours.

Magic Scarves 65 x 65

Set of 12, one colour, Chiffon

1911501 Magic Scarf blue

1911502 Magic Scarf green

1911503 Magic Scarf yellow

1911504 Magic Scarf purple

1911507 Magic Scarf orange

1911508 Magic Scarf pink

1911509 Magic Scarf red

1911510 Magic Scarf black

1911511 Magic Scarf white

1911505 Magic Scarf neon yellow

1911506 Magic Scarf neon green

1911555 Magic Scarf 138 x 138 set of 4

Special sized Magic Scarves in a set of 4 in assorted colors, 138 x 138 cm, chiffon, red, yellow, green, blue.

Parachute

Parachutes are the ideal play- and therapy-device for numerous activities of children as well as adults, smaller or bigger groups. An instructional brochure can be ordered separately.

Light nylon in bright colors featuring good swing-characteristics, for in- or outside play, in different sizes. Each parachute features a cord-fastened cut in the middle, steady handles on the edges and a stitched in rope.

1502301 Parachute 1,75 m Ø • 8 handles

1502302 Parachute 3,5 m Ø • 8 handles

1502303 Parachute 5 m Ø • 12 handles

1502304 Parachute 6 m Ø • 12 handles

1502305 Parachute 7 m Ø • 16 handles

1502914 Encouraging exercise with the parachute

1502915 Das Schwungtuch als Bewegungsinstrument

1502916 Il paracadute giochi in movimento



Tactile Discs

An inviting tactile material which challenges the children's sense of touch on both hands and feet. At the same time, it develops the ability to describe sense impressions verbally. The tactile discs, made of nice-to-touch sythetic rubber, contain different tactile structures, each with its own colour. Each of the tactile structure can be found on a large disc for positioning on the floor, as well as on a small disc that the child will be able to hold in his/her hands. In terms of playing, the discs offer innumerable possibilities ranging from a fundamental sensing of the tactile structures to blindfold games based on memory and recognition. The games can be adjusted, so that they fit the child's age and level of functionality. Maximum load 100 kg. Large disc 27cm, small disc 11cm. Age 2-8.

1502116 Tactile Discs – complete set

A set of 10 different tactile structures in a range of colours. 10 large and 10 small discs, a blindfold and a large cloth bag.

1502117 Tactile Discs set 1

Contains 5 large and 5 small discs, a blindfold and a cloth bag.

1502118 Tactile Discs set 2

Contains 5 large and 5 small discs, a blindfold and a cloth bag.

1502908

Ring Toss

A traditional game in unique quality and design. The popular tossing game is challenging both physically and mentally as it requires concentration and body control to asses the distance and throw the rings with precision. At the same time, the game is fun as it can be used in many kind of competition. The game includes two supports so that it can be placed at an angle to make the game easier for very small children. The game is made of metal and the rings of soft artificial rubber. Length 50cm, height 18cm, from 3 years.

1502907

Throwing Game

Four differently colored polyester bags are mounted on the large stand. Even young children of 2 years and up can practice throwing and play exciting games with the included 6 soft juggling balls. Players can assign different point-levels to the separate colored catching bags, counting accordant amounts of points. Height 67 cm, 70 cm diameter, suitable for small children 2 years and up.

1502169 Seesaw

Classic play equipment in a unique new design. Pliable synthetic rubber domes on the underside of the seesaw provide a softer, more dynamic movement. The seesaw has a non-slip surface. The base of the pivot is covered with sythetic rubber to reduce the risk of crushing and to prevent damage to the floor. Maximum load: 75 kg. Made in plastic with sythetic rubber cushioning. Age: 2 years and older.



Complete Set

Tactile Discs



Set 1



Set 2

VIDEO



Seesaw



VIDEO



Ring Toss



VIDEO



Throwing Game



Build N' Balance®

VIDEO



Large Set 1502239



Medium Set 1502238

Starter Set 1502229

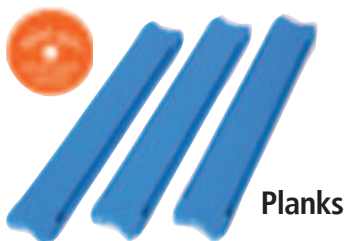

Planks

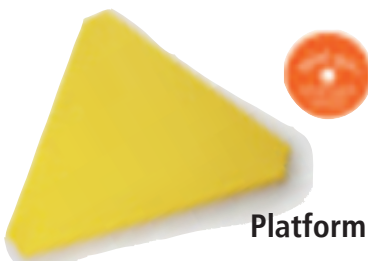

Platform



Top 10



Top 24



Rocking Plank



Log Plank



Bridge Pier

VIDEO



Build N' Balance

Exciting and challenging balancing system. The elements can be combined in countless ways, so use your imagination to set up all the balance courses and landscapes you can build. With the great flexibility of Build N' Balance the level of difficulty can be varied to suit the development levels of the children and can be built at height ranging from 10 to 24 cm. For children between the age of 2 and 10 years. Max. load 100kg.

1502229

Build N' Balance Starter Set

The set includes 2 Top 10, 3 Top 24 and 5 planks. Age 2-10.

1502238

Build N' Balance Medium Set

The set includes 3 Top23, 3 Top10, 3 Planks, 2 Log Planks, 1 Rocking Plank, 1 Tilting Disc. Age 2-10.

1502239

Build N' Balance Large Set

The set includes 2 Top 24, 6 Top10, 3 Planks, 3 Log Planks, 1 Slack Line, 1 Rocking Plank, 1 Bridge Pier, 3 Sticks, 1 Pair of Joints and 1 Tilting Disc. Age 2-10.

1502222

Build N' Balance Planks - Set of 3

Made of plastic and strengthened with steel bars. Length 72 cm, width 13 cm, height 3 cm, 3 pcs. in carton. Age 2-10.

1502223

Build N' Balance Triangular Platform

Made of plastic. Side length 59 cm, height 2 cm. Age 2-10.

Build N' Balance Tops

Made of plastic with artificial rubber edges to avoid slipping. Stackable for easy storage. Age 2-10.

1502226

Build N' Balance Top 10

High 10cm, Ø 27cm, yellow, 1 piece.

1502221

Build N' Balance Top 24

High 24cm, Ø 40cm, red, 1 piece.

1502225

Build N' Balance Rocking Plank

Element with integrated rocking function - the children have to transfer their weight as they move from top to top. The plank moves 6 cm as it rocks. Made in plastic. Length 72 cm, width 13 cm, height 10 cm. Age 3-10.

1502228

Build N' Balance Log Plank

Log Plant has a curved surface which requires the child's complete attention and body control to keep his/her balance. Length 73 cm, width 13 cm, height 6 cm. Age 4-10.

1502231

Build N' Balance Bridge Pier

This element allows children to build long, straight «bridges» which increase requirements of stimulation and balance. Made from plastic with non slip edge of artificial rubber. Requires purchase of blue Planks for the «bridges». Age:3+ , size 36 x 30 cm, h 24 cm, max. load 100 kg.



1502232

Build N' Balance Tilting Disc

The Tilting Disc is designed to strengthen children's proprioceptive sense and balance. The Tilting Disc consists of two hard plastic parts combined around a thick and moveable rubber connector, which gives way when children shift their centre of gravity. Must be placed in Top10 or Top24. Maximum load 75 kg. H 13 cm, Ø 22 cm. Age: 3+.

1502233

Build N' Balance Tilting Disc Set

Set contains of 1 Tilting Disc und 1 Top 10. Age: 3+.

1502224

Build N' Balance Slack Line

An element with a 5 cm wide and 68 cm long belt to cross on the way to the next top. A really great balancing challenge! The Slack Line can be tightened as required. Made of steel-reinforced plastic, polyester line and metal tightening mechanism. Length 73 cm, width 10,5 cm, height 8 cm. Age 4-10.

11502235

Build N' Balance Wobbling Plank

The Wobbling Plank is a challenging new element for Build N' Balance. The plastic plank is mounted on a metal axle and rocks gently sideward when the child is balancing on it. The degree of rocking is restricted to enable small children to safely balance on the Wobbling Plank. Made from plastic mounted on a 12 mm steel rod and has nylon bearings with rubber shock absorbers. Age 4+

1502255

Joints - set of 2

This versatile joints provide even more options for building play landscapes to challenge motor skills. Children can use the bars to build a tent by spreading a blanket over the bars. For safety reasons, the joints have been designed to allow the crossbars either to be mounted through the hole or placed loosely on top. 2 joints made of artificial rubber. Age: 2-10.

1502128

Balance Plastic Hemispheres, set of 6

Challenge anybody's balancing skills. For indoors and outdoors, heavy format, filled with sand. Children can balance on the flat or on the round side. Colourful set of 6 Hemispheres in red, blue and yellow, 15 cm diameter, height 7 cm. Maximum load 100kg. Age 2-8.

1502219

Hemisphere Stilts with cord, 1 set of 1 pair in box

1 pair of hemisphere stilts in colour red, 15 cm Ø, height 7cm. Maximum load 100kg. Age 5-8, packed in carton box.



Tilting Disc



Tilting Disc Set

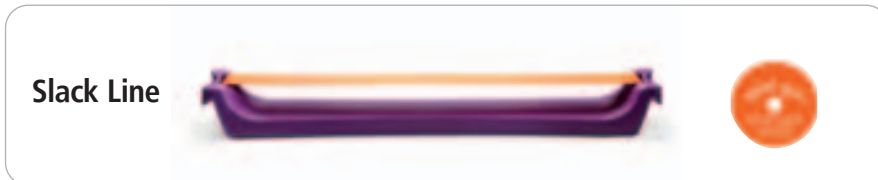

Slack Line



Wobbling Plank

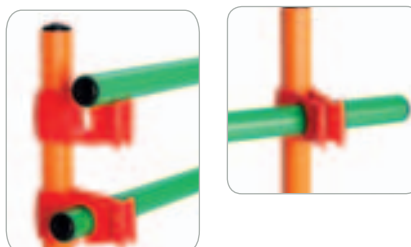

Joints

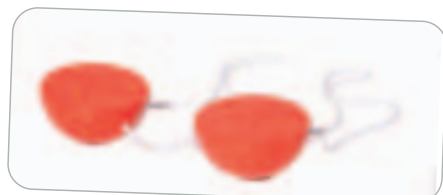
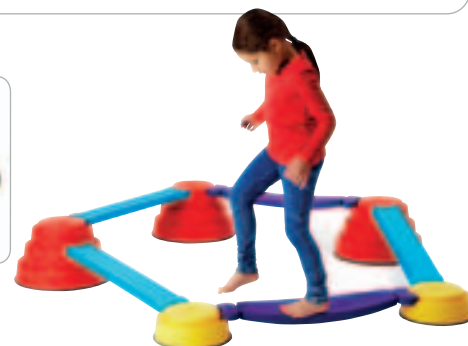

Hemisphere Stilts with cord



Balance Plastic Hemispheres





Floor Surfer®



VIDEO



15002168 Floor Surfer

Roller board for play and therapy. The Floor Surfer has been developed in partnership with children's physiotherapist to ensure safe use by any child irrespective of motor skills level. The Floor Surfer combines function, safety and design. The quality wheels with double ball bearing and non-smudging wheels in clear PU are screened to minimise the risk of running over the child's fingers (2). The Floor Surfer is slightly tapered at the front to give increase freedom of movement for the child's arm (1). The raised front part of the Floor Surfer supports the coccyx when the child is sitting (3) and the sternum when the child is lying down. The narrow sides act as handles where the child's hand are protected by the protruding corners. Made of plastic with inserts of EVA foam. Age: ½ - 10. L: 56 cm / W: 37 cm / H: 14 cm. Maximum load: 100 kg.

1502104 Rock Around

A spherical rocking toy for indoors and outdoors. Children can sit in it and rock from side to side, or spin around. There is even room for two smaller children to sit together. Users can hold on to the rim without getting their hands jammed between the rim and the floor. Develop physical coordination skills. 75 cm diam., 14cm high, from 1 ½ - 5 years.

1502102 Balancing Board

The Balancing Board is suitable for indoor or outdoor use, and is perfect for spinning around and rocking from side to side, whether sitting or standing. Equipped with a non-slip profile and four integrated handles, the board helps develop balancing skills and motor controls. Max. load 60 kg, 76 cm Ø. Age 3-10 years.

Bouncing River Stone

This adaption of the River Stone features a soft base and a hard top platform supported by three strong steel springs to enable bouncing, which requires adjustment through the child's ankles and legs, making it a more challenging activity than simply stepping. The Bouncing River Stone can be used on its own for special motor training activities, or together with River Stones to provide even more play possibilities. L 37 cm, W 37 cm, H 10 cm. Max. load 50 kg. Age 2+.

1502126 Bouncing River Stone

1502130 Bouncing River Stone Set
Set includes 1 Bouncing River Stone and 4 River Stones.

1502122 Mountain

A large high Mountain with broad steps, challenging children to climb. Smaller children climb step by step while bigger children can use the steps like stairs. Younger children can try to jump off the mountain – depending on age, height and abilities in relation to the 4 different step-levels. The Mountain also fits as a seat for one or several children. Made of durable blue plastic with skidproof rubber feet. Can be used for motor-skill-games and is an excellent addition to River Stones and Hilltops. Height 32 cm, length 65,5 cm, width 49 cm. Maximum load 100kg. Age 2-8.

Rock Around

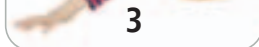

Balancing Board



Bouncing River Stone

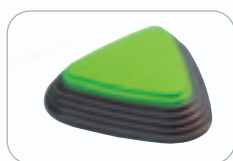
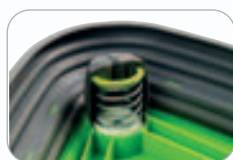

Mountain



1502120
River Stones, set of 6

Jump from stone to stone without touching the ground! The stones can be placed in any order to create challenging paths. Coaches sense of balance, body perception, coordination and motor skills. Set includes 3 large stones (36 x 36 cm, h 8,5 cm), 3 small stones (25 x 25 x 25 cm, h 4,5 cm) in 6 different colors. Each side of the triangle is varying in stepness and difficulties. Each stone has a rubber rim on the base which prevent them from slipping and also protect indoor floor areas. Maximum load 100kg. Age 2+.



River Stones



VIDEO



1502121
Hilltops, set of 5

Climb or jump from hill to hill while keeping balance! Children will learn to judge distances and will become familiar with altering heights. Trains sense of balance, body perception, motor skills and coordination. The set includes 5 differently colored Hilltops made of durable plastic in three different extents: 8,5 cm, 17 cm and 25,5 cm. Floor space of each Hilltop: 36 x 36 x 36 cm. Each tilt-proof Hilltop is provided with a rubber rim which prevent them from slipping and also protect the floor. Maximum load 100kg. Age 2+.

1502123
The River

River provides unlimited possibilities for building balance paths! The elements are easy to join and flexible at the same time so that only imagination defines the River's course. The element's size qualifies smaller children to build their «River». The elements are stackable for easy storage. Can be combined with the «Island» and the «Bridge». Age: 2-8. 6 elements in 6 colors L: 35,5 cm, W:11,5 cm, H: 4,5 cm. One closing element, L 15,5 cm, W 8,5 cm, H 4,5 cm.

Island and Bridge

Combining with River these elements provide totally new and stimulating play- and balance-parcours. The island will be a place to refuge, Bridge can be crossed over or be used in a cross format to represent a river running under a bridge. Made of durable plastic with non slip edge of artificial rubber. Max. load 100 kg. Age 2-8.

1502124
The Island

Set of two Islands in two different colors. L 43 cm, W 43 cm, H 7 cm.

1502165
The Bridge

Set of 2 elements in two different colors. L 50 cm, W 14 cm, H 7 cm.

1502166
River Landscape

An exciting balance landscape with no less than 25 elements: 21 river parts, 2 Islands, 2 Bridges. This set provides numerous options for exciting and challenging balance games, balance routes and balance activities.

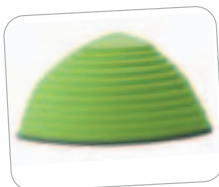

Hilltops



River Landscape



The Island



The Bridge



The River

VIDEO





Balancing Board



GymTop® Therapy Top



WippSider®



WippWalker®

1502110 Balancing Board wood black

Very suitable for balancing exercises and rehabilitation of both children and adults. Ideal for children as the balancing boards are completely smooth all the way round. Material: wood - the board is provided with a rubber cover. Maximum load 100 kg. Wooden hemisphere, h 8 cm, with a wooden disc, 35 cm diameter. Age: 4 years and older.

1010600 GymTop Therapy Top

Traditional therapy top for advancement of motor function, sense of balance, movement-coordination, body perception, perfect for rehabilitation and therapy. Durable red plastic-material made in one pour, 40 cm diameter, h 9 cm. With ski-proof, ripped surface. For children (3+), teens and adults. Maximum load 120 kg.

1013981 WippSider

The WippSider is a highly motivating sensomotoric trainings device. Its simple handling is convincing - by moving bodyweight from one side to the other controlled rocking movements are induced - and thus balance and posture can be improved.

52 x 13 cm, 9,5 cm high, blue high-quality molded plastic, produced in blow-technique, maximum weight 120 kg, for indoors and outdoors, to be used barefooted or with non-ski shoes, not suitable for children under 3 years, instructions for use.

1013980 WippWalker

By shifting his/her weight, the child will be able to «walk» with the WippWalker - but it is not easy, and small children will find it challenging. 52 x 13 cm, 9,5 cm high, maximum load 120kg, for children from the age of 3 years.

1502163

Arches set of 3

Multipurpose Arches designed to allow children to invent new ways of playing and create motor challenges; the possibilities are endless. An Arch can be placed either with the curved side up - forming a bridge - or down, turning it into a seesaw. Several Arches may be combined to form long extended pathways, or even placed on top of each other to amuse the more adventurous children. Arches will inspire children to find new ways of challenging themselves, limited only by their imaginations. Pleasant to touch, the Arches consist of a stable plastic core with a soft rim made from artificial rubber, providing anti-slep edges. A set of three sturdy Arches. Age 2 +. Maximum load: 75 kg. L 59 x B 21,5 x H 10,5 cm.

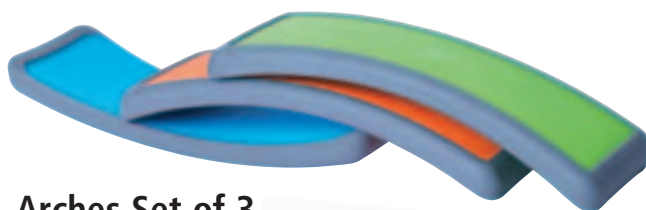

Arches Set of 3



1502260 Robo-Board

The Robo-Board trains weight transfer, dynamic balance and provides proprioceptive stimulation for children from 4 years. The Robo-Board moves easily by means of the child's weight transfer from side to side. When the child's weight is shifted to one side using muscular force and rotation around the spinal column, the child can rotate in a circular movement of up to 360 degrees.

The Robo-Board can be used to help children from four years to improve their muscle coordination, body consciousness, quality of movement and sense of flow, rhythm and regulation of force in their legs. The experienced user can get Robo-Board spinning and dancing – and can do tricks with it. Its cool visual design and multiple uses help to make Robo-Board challenging and inspiring for children of all ages – including teenagers.

Robo-Board has eight wheels. These are positioned so that the Robo-Board rotates when the child's weight is tipped onto four wheels on one side, whereas the board locks when the load is centred over the four wheels in the middle. Max load 75 kg. L 50 x W 16,5 x H 8,5 cm



Robo-Board

VIDEO



Roller

The Roller is a beautiful new conceptualisation of a fundamentally challenging motor activity object. Leave it out, and you will see both children and grown-ups tempted to test their skills by stepping up and trying to set the Roller in motion. It offers a progressive motor skills challenge, from small kids just managing to keep their balance with the support of a friend or a hand rail, to older children pushing the boundaries of what they can do without falling off. Whether it is used for play or in therapy, the Roller will stimulate the primary proprioceptive sense, as well as the vestibular and tactile senses.

The Roller is safe to use, as the compression of its rubber tyres naturally reduces the speed while making play virtually silent and protecting the ground surface from damage. This is combined with a rubber tread which provides a safe grip and offers additional tactile stimulation when rolling with bare feet. For younger children, the green version of the Roller contains 2,5 kg of sand, further reducing the speed and enabling even small children to master balancing and rolling. 35,5 cm, Ø 29,5 cm. Max. load 100 kg. Recommended for indoor, not recommended for outside use.



VIDEO



1502266 Roller with Sand

Alter: from 4 years

1502267 Roller without Sand

Age: from 7 years

1502138 Go Go

The Go Go encourages exciting and challenging motor activity developing body control. The Go Go - 3rd generation - has a modern design reflecting the ambition to manufacture strong and beautiful toys that are safe, stimulating and fun to play with. On the basis of years of experience, we have created Go Go to fulfill the quality requirements set forth by child care centers. Plastic wheels and pedals, steel axle 14 mm Ø and rubber tyres. For 1 child, 4 to 15 years, maximum load 50 kg. Without handles.

Roller without Sand

Roller with Sand

1502131 Handles for Go Go (in pairs)

One pair of handles, height 45cm. Made of steel (Ø 12mm) covered with surface-reinforced foam. Age 4-7.

1502139 Go Go Bus

When two or three children „board“ the Go Go Bus, they have to coordinate their movements, which children find both challenging and fun. Based on our many years of experience, we have designed the Go Go Bus to meet the quality demands made by child care institutions. L 53 cm, overall width 48 cm, h 16 cm. For 2 or 3 children of 4 to 15 years, maximum load 90 kg. Delivery without handles.

1502136 Handles for Go Go Bus (in pairs)

Handles (h 45 cm) made of steel (Ø 12 mm) covered with surface-reinforced foam. Age 4-7.



Handles optional



Handles optional

Go Go Bus

Go Go



Air Board 3er Set



VIDEO



Giant Air Board



These unique balancing board with a hard surface on a soft inflatable base are ideal for exercising motor control and strengthening muscles in the ankles, legs and upper body. The hard surface offers a safe grip for the feet while the inflatable base ensures smooth and gentle movements. Manufactured using a newly developed, patent-pending production method, the multifunctional balancing board offers an elegant design and extra thick, hard-wearing surface.

1502179

Air Board

The Gonge Air Board may be adapted to the functional level of the user by adjusting the pressure of the inflated air; increasing the pressure will speed up movements and make the balancing board more challenging. Suitable for play, training and rehabilitation at all ages from 3+ years up. Maximum load: 100 kg. H 12 cm, Ø 39 cm.

1502182

Air Board Set of 3

Three Air Boards in three different colours.

1502185

Giant Air Board

The Giant Air Board is an extremely versatile product. It can be used by people of all ages – for training and play. The Giant Air Board's dimensions mean that children can play with it standing, seated and lying down. The inflatable cushion gives the board a bouncy and mobile dimension not found in a regular balance board. The board tips on its inflatable base so that it can be used as a balance board or spring rider toy. This feature helps to make activities using the product more fun and unpredictable. The Giant Air Board can be used for play and training with the coloured side up or down. A Giant Air Board is ideal for play and building obstacle courses designed to improve motor skills, and as a supplement to many other Gonge products. Maximum load 100 kg. H 17 cm, Ø 58 cm. Suitable for play, training and rehabilitation at all ages from 3 years up.

Body Wheel is play equipment, of which some functions are mobile and unpredictable while others are static and stable. Children love the easily recognisable drum and soon become absorbed in making the Body Wheel roll. The width of the small and large versions of the Body Wheel respectively inspire children of all ages to crawl inside and explore the Body Wheel's movements while sitting, lying or kneeling inside the wheel. Children soon discover that it is also possible to roll on the outside of the Body Wheel. For compact storage, the small Body Wheel fits inside the large Body Wheel. Body Wheel can be used in play and for training, indoors and out.

Soft artificial rubber rims protecting children from squeezing fingers or toes and from damaging the floor.

**1502268
Body Wheel Small**

Maximum load 100 kg. H 30 cm, Ø 46 cm. Age: 3+
Made from fibreglass-reinforced PP plastic with TPE. Yellow and grey.

1502269 Body Wheel Large

Maximum load 100 kg. H 29 cm, Ø 59 cm. Age: 3+
Made from fibreglass-reinforced PP plastic with TPE. Blue and grey.

**1502270
Body Wheel Set of Small & Large**

Small Body Wheel und das große Body Wheel in einem Set.



Body Wheel Small

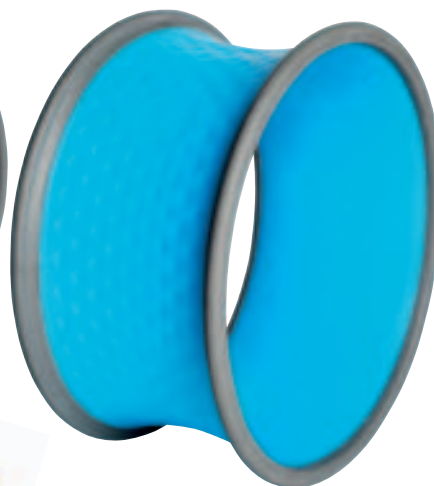

Body Wheel Large



VIDEO





Shoal of Fish



VIDEO



Fishing Rod

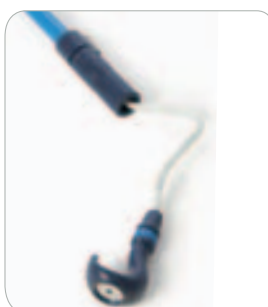

1502176 Shoal of Fish with 5 small fish

The shoal of small fish is ideal for free or teaching situations. Children are able to hide small items in the «belly» of the shoal fish as part of memory, sorting and naming games in linguistic or cognitive learning. The element of surprise in discovering what the fish has «eaten» provides excitement and motivation for children and keeps their attention in a teaching situation. The small orange buttons on the shoal fish make it possible to «catch» them with the fishing rod magnet (Art. 1502175), which offers an additional range of playing ideas. Shoal with 5 small fish, red EVA foam with orange buttons. Not suitable for use in water, magnets can rust. L 15cm, W 9cm, H 5cm. Age: 3-6.

1502175 Fishing Rod

Fishing requires motor skills and mental concentration, and develops children's balance and hand-eye-coordination. The fishing rod is well-suited, although not limited to the Shoal Fish (Art. 1502176), and can be adapted for use in imaginary and role-playing games involving interaction and language. Plastic rod with artificial rubber handles. Strong ceramic magnet on the underside. Overall length 90 cm, length of the cord 25 cm. Age: from 2 years up and older.

1502172 Fish Set of 4

A set of fun and brilliantly coloured fish. The fish have a hard plastic surface with non-skid structures fitted on an inflated base. The hard surface ensures a good footing while the inflated base yields to the child's movements. Playing with Fish is challenging for motor functions as children continually have to adjust their ankles and legs in order to find a way to keep the balance on Fish. The fish can be used as a stepping stone either during free play or as part of structured activities. Maximum load 75 kg.

1502174 Eyes for Fish

Eyes for fitting on the fish. Use fingers to press the loop together after which the eye is pushed up from below through the hole in the fish. The eyes make it possible to catch the fish with a fishing rod (Art.no. 1502175) The eyes are made from artificial rubber and come in a set of 5 colours.

1502127 Clown's Hat

The Clown's Hat encourages small children to perform - because it is not easy to balance with something on your head! Concentration and balance are required to wear the Clown's Hat which develops body consciousness and attention to posture. Playing with the Clown's Hat can be both individually challenging and form part of competitive scenarios. The Clown's Hat is shaped to make it easy for small children to use and the parts are so soft that dropping the rings does not hurt. Contains five parts made of artificial rubber and EVA foam. For children from 3 up to 6 years. Height 18cm, 14,5cm Ø.



Fish Set of 4



Eyes for fish



Clown's Hat

VIDEO



Activity Rings

New, brightly colored Activity Rings that appeal to children of all ages- and to adults. Activity Rings can be used as inspiration for countless activities such as dancing in a circle, walking on tiptoe in the rings, balancing the rings on your head, juggling rings on arms and legs, throwing rings to each other, jumping with rings around your legs, building figures - the combinations are limitless. The rings can be used in both spontaneous and structured activities during play, rhythmic and gymnastics. The rings can be used for individual and social activities.
Set of 6 rings in 6 colors, made of soft artificial rubber, diameter 16,4cm, thickness 1,2cm.

- 1502190 Activity Rings Set of 6
- 1502191 Activity Rings Set of 24

1502195 Mini Stilts

Unique stilts especially developed for younger children. The hard rubber handles provide a good grip that can be adapted to the height of the child. Depending on how brave the child is, the child can adjust the height of the stilts using the loose plateaux (from 3 to 15 cm). Even smaller children are able easily and safely to mount or remove the plateaux. The Mini Stilts are easier for younger children to use than pot stilts or traditional wooden stilts. The handles allow an older child or an adult to help younger children who have not yet mastered the stilts on their own. Made of plastic base with sole and handle of artificial rubber. The plateaux are made of plastic. Maximum load 100 kg. H: 71 cm, W: 17 cm, L: 27 cm. Age: 3-7.

1502106 Round Seesaw

The Round Seesaw amuses and excites children as it can move in all directions. Particularly suited for smaller children (age 3-5) and can be used even by two children at the same time. Height 60 cm, 76 cm diameter, maximum load 60 kg. with two soft foam-coated handles.

1502108 Summer Skis

Summer skis look easy to use, but it can be difficult to keep in step. The skis train the basic motoric functions, as the children must coordinate their movements. Made of wood with anti-skid rubber pieces which protects the floor when used indoors. Length 88 cm, maximum load 150kg. Age 5+.



VIDEO



Activity Rings



Mini Stilts

Round Seesaw



Summer Skis

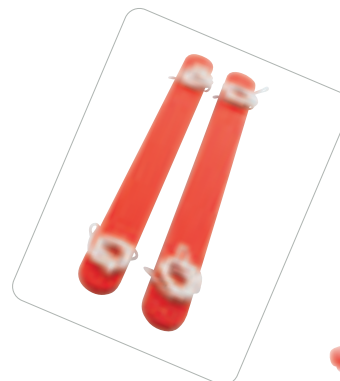



Koala

VIDEO



1502097 Koala

Decorative toy with a wealth of possibilities. When children sit inside the Koala, they are able to rock or rotate like a carousel. If the Koala is turned upside down, it becomes a small den. Several Koalas can even be combined into a play tunnel. Playing with the Koala stimulates children's vestibular sense and develops their balance. Can be used by one or more children. The Koala is made from thick (8mm) plastic. The exterior has a circular moulding that prevents the Koala from rolling around and children falling out or jamming their fingers. Max. load: 50 kg, diameter: 58 cm, height: 44 cm, weight: 3,5 kg. Age 1 - 6 years. Colour blue is darker than shown.

1502095 Shoes for Koala - Set of 3

Non-slip shoes for Koala made from artificial rubber. Set of 3. 18 x 5 x 5 cm

1502167 Carousel

Exciting mini carousel giving children a real spin! The seat is placed at a slight angle to allow the child to propel the Carousel by shifting the body's centre of gravity. Younger children are also able to set the seat in motion by pushing of with their feet. The seat has a thick edge to make it easy for children to get a good grip and hold on when the Carousel is moving. Playing with the Carousel develops muscle integration and strengthens muscles. Children's vestibular sense in combination with sight is also stimulated to help improve balance. The Carousel consists of a solid, moulded plastic seat which is placed on a steel disc mounted with a rotation joint including two ball bearings. A solid and stable metal base with rubber feet ensures safe spinning of the Carousel. Maximum load 75 kg. Weight 6 kg, Ø 56 cm, height 34 cm. Age 3-10.

Shoes for Koala

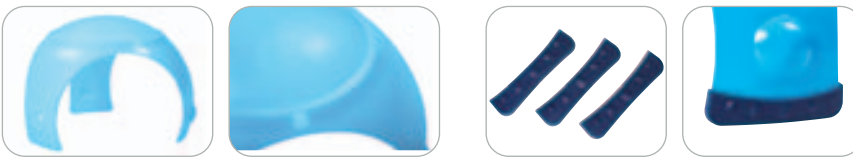

Carousel

VIDEO



1502406 Baby Trampoline

On this trampoline very small children can practise trampoline jumping. The canvas is tensioned such that even small children will experience a springing effect which they would be too light to feel on ordinary trampolines. The spring sheet is only 18cm above the floor. The rubber cover yields protection against the metal frame and the supporting handles are covered with foam to protect face and teeth. Solid construction, Height 20 cm / 65 cm, 70 cm Ø, for children from 1 1/2 to 4 Jyears, up to 20 kgs.

1502400 Trampoline

Beautifully designed and functionally correct trampoline for children. The sloped protective cushion with high rear edge (11 cm) yields utmost protection during play. Even younger children can safely use the trampoline with attached handle. Jumping the trampoline effectively supports the child's advancement in motor skills and balance-feel. Durable design: a welded steel-construction, steel-spring-hanging, tightened jumping sheet (103 cm diameter). The foam-coated handle is included and can be attached in demand (height 80 cm with handle, without 28cm, resilient up to 50 kg). For 1 child of 3 years and up.



Baby Trampolin



Trampolin

1502101

Top

A wonderful giant top for hours of fun. In the original Gonge Top, 1 or 2 children can rock from side to side, spin it, build a dent, hide and small children can even use it as a boat in water (only under adult supervision). Develops children's physical coordination while they play. Made of strong durable red plastic for both indoor and outdoor play. Very suitable for basic physical coordination training with disable people. 80 cm diameter, 44 cm high. For 1 or 2 children, 3 to 10 years. Loading capacity 100 kg.

1502099

Mini Top

The Mini Top was developed with particular focus on the motor-skill development of children aged 0-4. The Mini Top invites young children to teeter, swing and spin around - at first with the help of an adult and subsequently on their own. It encourages motor activities which are important for a child's early development of his/her sense of balance (the vestibular system) and motor control. The shape of the Mioni Top makes it safe for young children. The geometric shape ensures that the tilting motion gradually slows down and prevents the child from tipping over the same time. The Mini Top has been carefully designed to make sure that both the child's head and fingers are protected during play. Age 0 - 4 years, 68 cm Ø, height 26,5 cm, weight 1,6 kg, colour orange. Loading capacity 50 kg.

1502098

Cushion for MiniTop

Soft, grea cushion intended to make infants feel safe and comfortable in the Mini Top. Made from quilted fabric with anti-skid rubber dots at the bottom. 64 cm diam., weight 350 g, Age 0-2. Washable at 30°.

1502090

Weighted Sensory Blanket for Mini Top

The Weighted Sensory Blanket stimulates the body's sensory receptors, providing a flow of input to the brain that increase body awareness. Research and clinical observations offer compelling indications that this improves calmness and wellbeing, and has a therapeutic and soothing effect. The sensory blanket containing hollow plastic chestnuts is comfortable to lie on and applies a gentle pressure of 3kg/m² when a child lies underneath. 75 cm Ø, height 3 cm. Age: 0 - 3 years. Washable up to max. 30 degrees.

Top



VIDEO

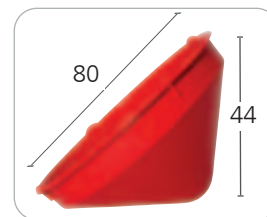

Mini Top



Cushion for Mini Top

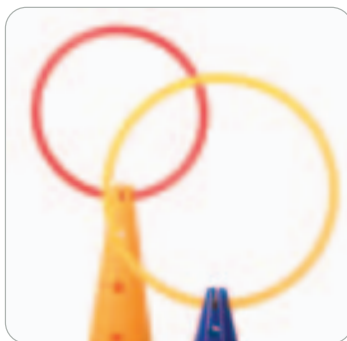

In cooperation with physiotherapists and occupational therapists, Jakobs develops innovative play and movement devices by which children and adolescents can playfully practise and train motor and sensorimotor skills such as balance, coordination, mobility, body control, physical condition, and reactivity, strength and strength dosage. A high demand character and fun factor in combination with the best quality and safety features as well as the manufacturing guarantee Made in Germany characterize for the most part all Jakobs products.

50

Function Cone 30 cm high

Made of a high quality material, available in 4 colours: red, yellow, green and blue, with slots on the top to insert hoops. These cones have symmetrical holes on the sides to connect poles at different heights.

- 5101101 Function Cone 30 cm, red
- 5101102 Function Cone 30 cm, yellow
- 5101103 Function Cone 30 cm, green
- 5101104 Function Cone 30 cm, blue

Function Cone 50 cm high

Made of a high quality material, available in 4 colours: red, yellow, green and blue, with slots on the top to insert hoops. These cones have symmetrical holes on the sides to connect poles at different heights.

- 5101201 Function Cone 50 cm, red
- 5101202 Function Cone 50 cm, yellow
- 5101203 Function Cone 50 cm, green
- 5101204 Function Cone 50 cm, blue

Function Cones

30
Flat Hoops

These nylon hoops with flat section are made of a high quality, flexible, shape-memory material which immediately returns to its original shape. Highly resistant. Available in 4 different colours and 4 diameters: as a set of 4 coloured sorted and in 4 different sizes, hoops per colour and size: delivery in packing units only (4 pcs.).

5101311 Flat Hoops Set of 4

Sorted colours and sizes, 40, 50, 60, 76 cm diameter.

- 5101301 Flat Hoops 40 cm red, 1 unit = 4 pcs.
- 5101302 Flat Hoops 40 cm yellow, 1 unit = 4 pcs.
- 5101303 Flat Hoops 40 cm green, 1 unit = 4 pcs.
- 5101304 Flat Hoops 40 cm blue, 1 unit = 4 pcs.

- 5101341 Flat Hoops 50 cm red, 1 unit = 4 pcs.
- 5101342 Flat Hoops 50 cm yellow, 1 unit = 4 pcs.
- 5101343 Flat Hoops 50 cm green, 1 unit = 4 pcs.
- 5101344 Flat Hoops 50 cm blue, 1 unit = 4 pcs.

- 5101351 Flat Hoops 60 cm red, 1 unit = 4 pcs.
- 5101352 Flat Hoops 60 cm yellow, 1 unit = 4 pcs.
- 5101353 Flat Hoops 60 cm green, 1 unit = 4 pcs.
- 5101354 Flat Hoops 60 cm blue, 1 unit = 4 pcs.

- 5101361 Flat Hoops 76 cm red, 1 unit = 4 pcs.
- 5101362 Flat Hoops 76 cm yellow, 1 unit = 4 pcs.
- 5101363 Flat Hoops 76 cm green, 1 unit = 4 pcs.
- 5101364 Flat Hoops 76 cm blue, 1 unit = 4 pcs.

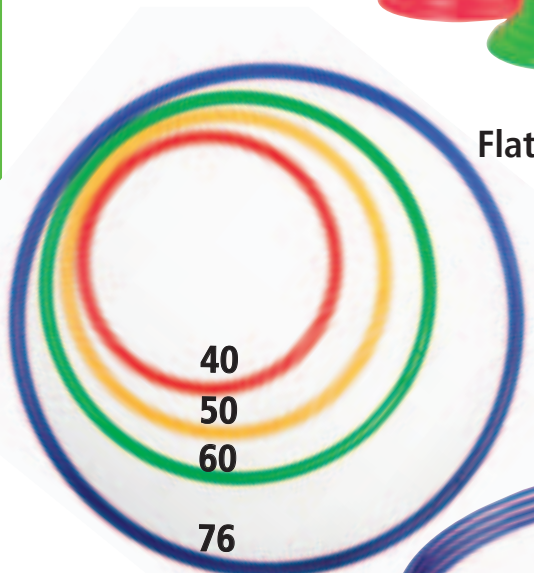
Flat Hoops

40
50
60
76

Poles

Gym poles with Ø 25 mm. In shockproof safety plastic. The ends are sealed with rounded scratchproof caps. Compatible with the base for obstacles (art. 109) and 30 cm (h) and 50 cm (h) cones to create many different courses. Poles are available in 3 different lengths, each length in 4 colours. (Not suitable for use in water)

- 5101401 Pole 80 cm, red
- 5101402 Pole 80 cm, yellow
- 5101403 Pole 80 cm, green
- 5101404 Pole 80 cm, blue

- 5101411 Pole 100 cm, red
- 5101412 Pole 100 cm, yellow
- 5101413 Pole 100 cm, green
- 5101414 Pole 100 cm, blue

- 5101421 Pole 120 cm, red
- 5101422 Pole 120 cm, yellow
- 5101423 Pole 120 cm, green
- 5101424 Pole 120 cm, blue

120 100 80
Poles

5101334 Fixing Clip Pole/Hoop, blue

The blue clip has a turnable centreline and combines poles and hoops.

5101331 Fixing Clip Pole/Pole, red

The red clip has a turnable centreline and combines poles.

5101333 Fixing Clip Jolly Support, green

By using a green clip a pole can be placed loosely between two static poles. By doing so pole can drop down in case of contact and therefore an additional challenge is given.

5101226 Set of 12 Functional Bricks

Large, functional bricks made of tough, safe plastic. They are highly versatile, easy to fit together (like LEGO bricks) and can be used to build obstacle courses for motor skills activities. The slots on the bricks have been specially designed so hoops and gym poles can be easily – but safely and securely – fitted into them to create endless combinations. Available in a set of 12 in 4 colours: yellow, red, green and blue. Dimension of one brick: 26 cm x 13 cm x 7,5 cm.

Motor-Activity-Sets

Coordinated motion sequences and controlled physical activities are pre-conditions for the development of childrens' motor skills. These sets provide a vary of arrangements with consistently new and exciting situations and activities to establish and encourage primary motor skills. Different combinations with the elements of these motor-activity-sets provide the implementation of a lot of motion-activities and challenging obstacle courses with changing requirements: to go slowly, to go fast, to run, to balance, to bounce, to climb beyond and through, to change directions, to rise above or to sidestep obstacles, to run through and much more.

5101501 Multi Action Set

- 2 Function-cones 30 cm high
- 2 Function-cones 50 cm high
- 4 Poles 120 cm long
- 4 Flat hoops 40, 50, 60 und 76 cm diameter

5101502 Multi Motorik Set

- Motor-activity-set with 28 elements and 4 fixing clips:
- 20 Functional bricks in 4 colours
- 4 Poles 80 cm long
- 4 Flat hoops 40, 50, 60 und 76 cm diameter
- 4 Fixing Clips (2 red ones, 2 green ones)

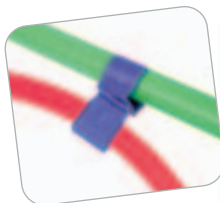

Pole/Hoop

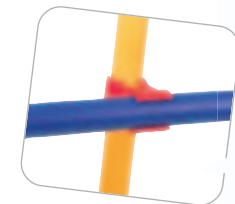

Pole/Pole

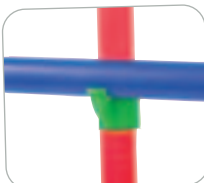

Jolly Support



Clips



Functional-Bricks



Multi Aktion Set



Multi Motorik Set



Megatunnel

1072124
Megatunnel

With 91,4 cm diameter and 3,7 m length the Megatunnel is one of the largest - if not the largest - collapsing-spring crawl tunnels. The combination of its cavernous interior and vivid six-color design makes it one of the most inviting visually exciting tunnels. Megatunnel can be knocked to one another, end to end, to form an infinite variety of expandable and curved pathways.

1072232
See-Through Tunnel

This tunnel provides a safe, non-threatening way to encourage gross-motor exercise and cross-patterning coordination. This durable, transparent mesh tunnel enables kids to see out and helps you provide better supervision. The unique see-through shell of the tunnel reduces feelings of enclosure for kids who may be nervous. Tunnel ends offer the ability to connect multiple tunnels thanks to their Velcro® parts. Folds flat. Includes a carry bag for easy storage and transport. Total length: 2,5 m Diameter: 50 cm

See-Through Tunnel

1010590
Canvas-Tube

Durable tire canvas in orange, boosted edge, 4 meter long, seize of the opening is 65 cm, for indoors. The tube made of durable canvas fabric provides an exceptionally creeping and crawling experience: moving forward and crawling through the long textile tube is always challenging and encourage playideas full of fantasy and creativity. Designed for a lot of age-groups for play and education, sports in schools, for therapeutic exercising and rehabilitation. Enhancement of motor- and psychomotor-skills, coordination, body perception, control of motion, coordination, group- and role-plays.

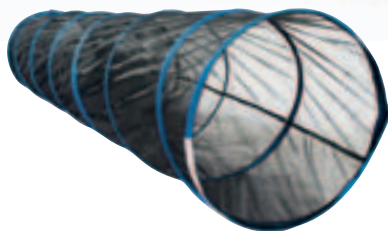
Canvas tube
1010530
Samba Rope Pulling

An active, challenging kind of balancing game for two «Sambadancer», which combines such aspects as equilibrium, strength and cleverness. By means of sensitive and skillfully pulling both players try to unsettle one another and to get off the island-mat. The first who is touching the ground or the «water» around the islands is the loser of this game. «Samba» is practical for children from 7 years up, older children and young adults. The 2,80 m long Samba-belt with a loop on each end is made of tearproof, wear-free belt-strap. The island-mats (4 mats, 34x21 cm, colours may vary) are 2 cm thick and made of non-slippery, certified material with antibacterial finish. Incl. instruction and rules of the game.

- **Learning values:** balance training, coordination, body control, flexibility, reaction, concentration, cleverness
- **Field of application:** play and leisure, schoolsport, gymnastics, therapy, psychomoto, fitness training

1010595 Play-caterpillar

Stable and durable heavy-duty woven fabrique for a never-ending treadmill with 9 meter circumference, 73 cm wide, weight 4,4 kg. Endlessly welded, for indoors and outdoors, color auburn.

Samba Rope Pulling

Play-caterpillar 9 m circumference

1013990

SwingTop

(DE-Patent Nr.: 10257307.7) • (US-Patent No.: 6,874,851)
To rock and swing with ropes in sports halls without danger or risk for injury and to have fun instead - is professionally doable again by the SwingTop. The fact that it is easily installed and taken away again, optimal for sitting and standing, it's perfect size and the stable, high-quality material allows numerous possibilities in sports and playing - rocking, swinging, and turning with the ropes. The loop is automatically pulled tight by the body weight when sitting or standing on the SwingTop and also stays knotted safely whilst using. Still, the device can easily be removed when not in use. Several SwingTops can be stacked on each other or lined up on a bar to save space. It is designed for any age-group or weight-class in sports, in schools and clubs and for therapeutic exercising. Enhancement of motor skills, body perception, training of balance, relaxation, self-confidence. TÜVRheinland-certified.

Stable device of plastic, 22 cm Ø, 7 cm high, blue molded hollow body with stable insert, weight 400 g, made in Germany. The opening in the middle fits for all standard climbing ropes in schools: Simply lead the end of the rope through the opening in the middle from top downwards through the yellow insert, then through the emerging loop and pull fast.

Climbing-Rope for SwingTop

Sleek high-quality climbing-ropes made of long hemp, 33mm diameter, equipped with a sturdy rope-fastener on the upper side and a plastic cover on the other one. The ropes are available in 3 different sizes for combination with the SwingTop; please subtract 50cm from each length due to the installment of the swinging-plate. A shackle can be hinged to the fastener on demand to extend the lug.

- 1013993 Climbing-Rope 250cm
- 1013994 Climbing-Rope 300cm
- 1013995 Climbing-Rope 350cm
- 1013996 Shackle M 10 zincked

1013991

Seat and Impact Protection for SwingTop

Soft seat protector and impact protection is pulled over the SwingTop. It ensures comfortable sitting when swinging and provides additionally more safety, when more than one children is swinging. Made in Germany, from soft, foamed PUR-plastic, PAK-free, in signal grey, Ø 24 cm.

Mera-Floorball

Floorball (Unihockey) is a fascinating team game for girls and boys - also mixed - for active people of any age, from kindergarten to senior care. The rules have a plain structure and are quickly understood by everybody. Together with the play-material (light flexible sticks and a ball of 23 g only) this assures safe playing - hardly without any injuries. Floorball is dynamic and highly motivating for children of any age - even in smaller groups - and develops the ability to play remarkably, actually also for other games like basketball, handball, etc. It is designed for any age-group or weight-class for sports in schools, in clubs, sports for handicapped and for therapeutic exercising. Enhancement of motor skills, coordination, condition, capability, reaction, ability to play in a team, experiencing of team spirit, fun-sport.

1010800 Mera-Floorball-Set Kids L 80

8 staffs (length 80cm), 8 white balls. For 8 players, pre-school- and day-nursery-children up to approx 150 cm body height

1010820 Mera-Floorball-Set Kids L 73

8 staffs (length 73cm), 8 colored balls. For 8 players, here: kindergarten and preschool up to approx 135 cm body height.

1010830 Mera-Floorball-Set Kids L 63

8 staffs (length 63cm), 4 colored balls. For 8 players, this size is perfect for the youngest in kindergarten

1010840 Mera-Floorball Goal

High quality PE material with net (40 x 55 cm). The Floorball-Goal is easily assembled and adds an exciting aspect to teamplay.



Seat and Impact Protection



Climbing-Rope for Swing-Top®

Mera-Floorball



Set Kids L 80

**Set Kids M 73
Set Kids S 63**



Air

Dribbler

Play

Mera-Floorball Goal



Motorik • Bewegung • Spiel • Jakobs

Anti-Aggression-Bats

Necesso® bat PLUS - small
Necesso® bat PLUS-large

Necesso® bat STANDARD large
Necesso® bat STANDARD small

Hopsacks in 4 colours
Necesso™ Bats (Anti-Aggression-bats)

These are bats for aggression relief and are primarily used in family therapy. Being usefull in playful unrestricted rituals to relieve aggesion, frustration and physical tension they are an important therapy tool and technique for working and being guided in many educational and therapeutical fields of activity. The important learning process to deal with problems and conflicts, to help solving problems and to fight out fair is a fundamental important experience for children and adults in all formation of groups (e.g. kindergarten, school, family, partnership, therapy, workplace). (Self-)perception, body language and interaction be sensible and experienced directly by working with Necesso bats under therapeutice supervision. Feelings of aggression are changed into operating power and avoid deleted anger and feelings. Working with Necesso bats should always be under supervision to consider individually risks and to develop regulations within a group.

We offer our Necesso Bats in two sizes (for small children and older children, youths and adults) in two different qualities:

- **Plus-Quality**, covered with hard-wearing and skin-friendly canvas material, all parts manufactured in Germany.
- **Standard-Quality**, covered with durable Nylon material, manufactured in Europe.

Necesso Bat small

The small Necesso bat, available for small children in kindergarten and primaryschool, will help them to recognize their aggressive emotions and vent their rage in a controlling way.

Necesso Bat large

Working with the large Necesso bat provides older children, youths and adults to gradually reduce feelings of aggression, to canalize and to refl ect them within the group.

4370455
Necesso bat PLUS - small

12 cm Ø, 35 cm long, whole length 52 cm, weight 270 g. The small Necesso bat, available for small children (kindergarten, primaryschool), will help them to recognize their aggressive emotions and vent their rage in a controlling way.

4370456
Necesso bat PLUS - large

15 cm Ø, 63 cm long, whole length 78 cm, weight 500 g. Working with the large Necesso bat provides older children, youths and adults to gradually reduce feelings of aggression, to canalize and to reflect them within the group.

4995207
Necesso Bat STANDARD - small

12 cm, whole length 55 cm, weight 480 g, colour red.

4995208
Necesso Bat STANDARD - large

16 cm, whole length 75 cm, weight 820 g, colour blue.

Hopsacks

Our hopsacks are made of durable, long-living cover fabric, tearproof and washable. Ideal for sports- and leisure time, 58 cm x 40 cm. Made in Germany.

1000830 Hopsack green
1000831 Hopsack blue
1000832 Hopsack red
1000833 Hopsack yellow

Boxing Base

A stable punching bag only for children! This Boxing Base will not drop easily and can absorb punches and blows very well. That way aggressions and stress can surface and channel purposefully and without any harm. Strength, flexibility and endurance can be measured up playfully, either in single play or individual training or in many movement activities for two children or for groups. Punching bag made of firm foam with a sandfilled base for stability. The material of the outer cover is washable polyester and PVC (1100 DITEX) with a covered sewed zip.

4995209 Boxing Base 110

110 cm high, cylinder diameter 25 cm, stand diameter 40 cm, weight 15 kg. For children from 4 years.

4995298 Boxing Base 140

140 cm high, cylinder diameter 35 cm, stand diameter 55 cm, weight 31 kg. For children from 8 years.

Sash

Sash for group lessons, team sports and competition are made of durable, comfortable ribbon, 59 cm long, 5 cm wide. Made in Germany.

1000820 Sash blue

1000821 Sash yellow

1000822 Sash green

1000823 Sash red

1072123 Kendo Bat

Kendo, a traditional Japanese martial art, can be imparted in physical education safely and with minimum efforts due to the light bats made of sturdy foam (always under supervisor or professional guidance respectively). Footwork and hitting-practice are the basics of Kendo. Each player tries to touch the combatant with his Kendo Bat, while trying not to get touched himself. Touching once, twice, only touching the arms, only touching the legs etc. The Kendo Bat's handle is separated into two parts by a ring in order to mark the ideal holding position for the hands.

1072123 Kendo Bat

Overall length: 78cm, handle 30cm, 7cm bat-diameter.

1072240 Kendo Bat Junior, set of 2

Overall length: 60cm, handle 20cm, 7cm bat-diameter.



Sashes



Boxing Base 110



Boxing Base 140



140 cm high!
For older and bigger kids

Kendo Bat Junior set of 2



Kendo Bat



Contura® Trail Set of 6
1013985
Contura Trail Set of 6

Each element of this balance trail has a different surface structure with very different tactile and stimulating sensoric sensations and a changing massage effect to add. The beautiful well defined colors provide a great visual impact and can be involved with tasks of perception or other therapeutical activities. Two extra connection-clips fixed to each element on short and longer side are particularly innovativ. This allows an endless number of various configurations connected stadily and securely. An optimal product for the improvement of sensory motorskills, perception, therapy, rehabilitation, children's and adult gymnastic.

The Set includes 6 contoured balance-elements, each 52 cm long, 14 cm wide and 4 cm high, with 4 non-skid rubber basepoints, high quality molded plastic, produced in blow technique. Six different topological outlined surfaces: elements with lengthwise waves and zig zag pattern, with diagonal and transverse groovings, with small rounded bumps which enhance a strong massage feedback and with smooth rounded bumps. For maximum weight up to 120 kilo, not suitable for children under 3 years, to be used barefooted only, easily to clean (for disinfection, too), incl. instruction.

1013720
Pedoball

Putting the rubberball into a smooth run by circular motion while standing on one leg – a challenging variant demanding balance, stability and motor-coordination. To start up small children can operate the Pedoball by hand and try to roll the ball in oval circles or – improving – move several balls at a time. In order to develop a feel for the unstable underside (hemispherical bow), practice can be exercised while sitting down. Challenge and fun will grow when using one Pedoball on each foot. The speed as well as the number of balls (up to 5) are self-affected. Oval, orange-coloured basic form with rut, skid-proof structured surface; hemispherical bow on the underside. Solid high-quality plastic, able to work under pressure of up to 120kg; L 47,5 x B 27,5 x 7,5 cm, weight 710 g, incl. 5 rubberballs. The broad hook-and-loop-fastener is easy to handle and fits for all sizes of feet or shoes. To be used bare-feet or with skid-proof shoes; inside and/or outsides. For children 4yrs & up, teens and adults. Instructionsincluded.

- **Learning values:** motoric motion sequence, balancing, coordination, body-control, posture, condition, one-leg-stand, ankle-prophylaxis, musculature-strengthening

- **Range of use:** kindergarten, pre-school, school, play and leisure, integration facility, gymnastics, sports, therapy, rehabilitation, work with seniors.

Pedoball®

PEDOBALL®

1013983
WippSider® PRO

WippSider PRO is a trainings device for exercising and encouraging balance and sensomotoric abilities playfully. Suitable for children from 4 years and adults. Due to radial run-out at centre user get visual stimulation and additionally feedback of movement performance by moving the rubber ball. By moving bodyweight from one side to other controlled rocking movements are induced and thus hard rubber ball moves all around. The more regular the rocking movements when wide support surfaces at the side facing the ground, the more stable is the ball's radial run-out. Other rubber ball can be used as substitution, or as second ball for a greater challenge. Behind one another, opposing, with stopping, clock-wise or anti-clock-wise...

WippSider PRO offers many game variations for improving the physical feeling and balance combined with a high fun factor.

52 cm x 20cm, 8 cm high, high-quality molded plastic in purple colour. Flawlessly produced in blow-technique, made in Germany. Maximum weight 120 kg. Not suitable for children under 3 years, for indoors and outdoors, to be used with non-skid shoes or barefooted, including instruction.



WippSider® pro

1013980
WippWalker

The WippWalker allows your body to be moved forward or backward and you might wish to keep control over a racing path - perhaps with a slight slope built in - alone or with increasing motivation competing with others playing in groups.

52 x 13 cm, 9,5 cm high, green high-quality molded plastic, produced in blow-technique, maximum weight 120 kg, for indoors and outdoors, to be used barefooted or with non skid shoes, not suitable for children under 3 years, instructions for use.

1013981
WippSider

The WippSider is a highly motivating sensomotoric trainings device. Its simple handling is convincing - by moving bodyweight from one side to the other controlled rocking movements are induced - and thus balance and posture can be improved.

52 x 13 cm, 9,5 cm high, blue high-quality molded plastic, produced in blow-technique, maximum weight 120 kg, for indoors and outdoors, to be used barefooted or with non -kid shoes, not suitable for children under 3 years, instructions for use.

1013982
Set of WippWalker/ WippSider

1 WippWalker and 1 WippSider , including instruction.



WippWalker®

WippSider®

WippSider®



WippSider® PRO



WippWalker®





www.tuv.com
ID 1111217336

Balanco System US-Patent No.: 6,461,285
DE-Patent Nr.: 101 34 577 - TÜV-certified

Balanco is a high-quality product designed to improve psycho-motor/sensorimotor control and coordination, and especially to enhance balance and general fitness.

The scientifically based development and trials with the Balanco allow highly varied training of various types of movement, thus increasing motivation.

The inserts can be changed very easily, every insert has a different challenge and vary the exercises for different requirements and levels of difficulty and thus allows individually modified applications.

Enhancement of training of balance, vestibular perception, control of movements, coordination, mobility, concentration, reaction. Ideal for therapy and self-therapy, rehabilitation, orthopedic applications, sports- and fitness training, psycho- and sensor-motor skills, play and educational, school-sports, work and sport with elderly people.

Base of high-quality durable plastic, color dark grey, 54 x 40 cm, 10 cm high, complete set with 3 alternative inserts plus transparent cover of Plexiglas, for maximum weight up to 120 kg, not suitable for children under 3 years. Packed in a decor sales box, incl. detailed instruction for use in 6 languages. Meets ASTM F963 toy safety standards. TÜVRheinland certified.

Balanco Safety Straps

The straps - available as optional extras in 2 different lengths - are designed to give users better security and control of movements. The straps can easily be hooked into the slits in the sides of the Balanco. Made of high-strength woven fabric with ergonomically molded handles.

1013968

Balanco Safety Straps short

1 pair of safety straps, adjustable from ca. 38 to 60 cm.

1013969

Balanco Safety Straps long

1 pair of safety straps, adjustable from ca. 58 to 72 cm.

VIDEO



Balanco® Safety Straps

Balanco System US-Patent No.: 6,461,285
DE-Patent Nr.: 101 34 577 - TÜV-certified

• **Balanco Sets**

1013505

Balanco Set 1 Mouse Game

Base with 3 alternative inserts: yellow mouse-game with 1 mouse-ball, red labyrinth, blue figure of 8, 1 rubber ball, incl. instruction.

1013506

Balanco Set 2 Basketball Game

Base with 3 alternative inserts: green basketball game with 3 hard rubber balls, red labyrinth, blue figure of 8, incl. instruction.

1013507

Balanco Set 3 ZigZag

Base with 3 alternative inserts: purple Zigzag, orange Taurus-maze with 1 hard rubber ball, yellow mousegame with 1 mouse-ball, incl. instruction.

1013508

Balanco set 4 Obstacle

Base with 3 exchangeable inserts: Obstacle (light blue), YingYang (light green), ZigZag (purple) 2 hard rubber balls, including manual

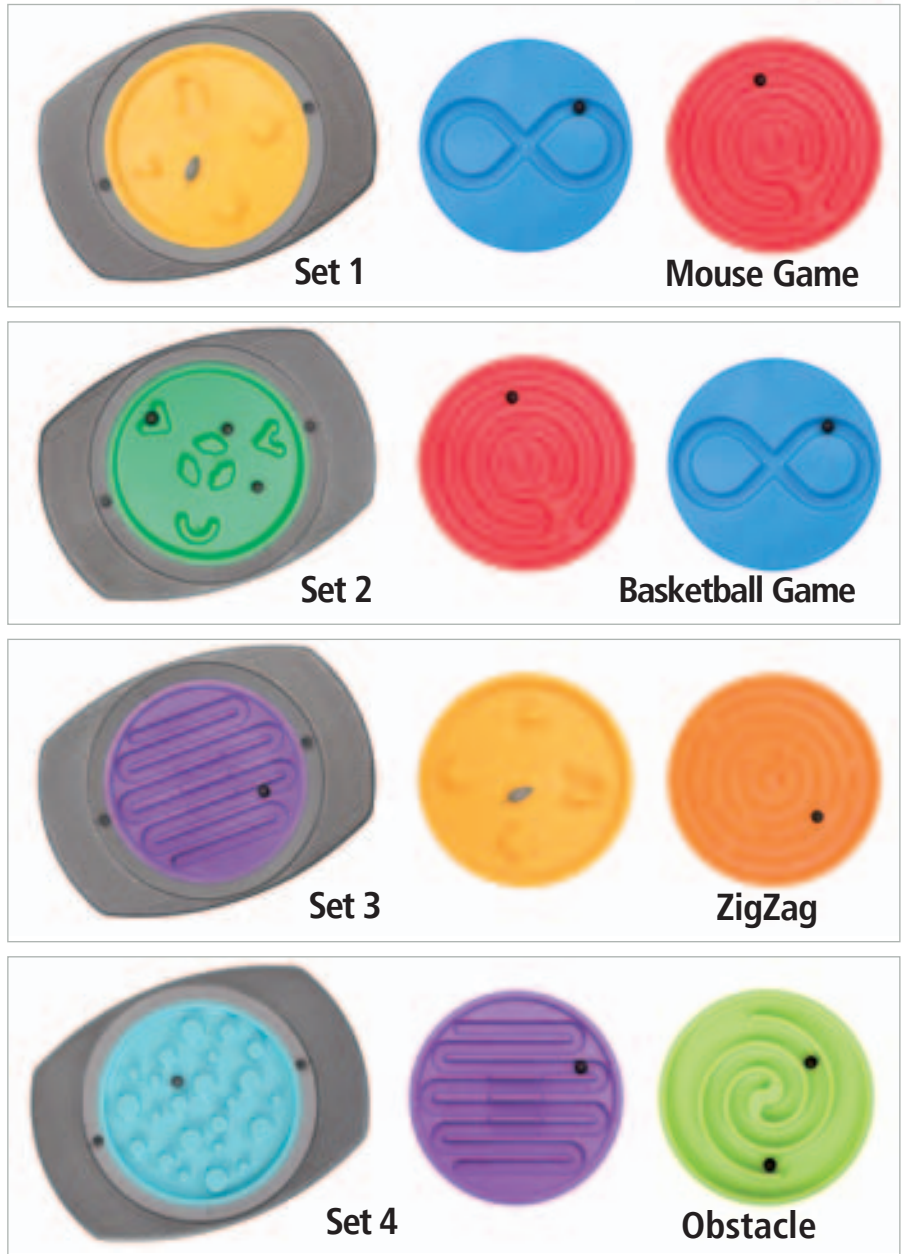

Inserts can be changed very fast and easily.



Decor Sales Box





Rolleppo®



2 levels of difficulty



size adjustable from 79 - 99 cm

Rolleppo®

(according to an idea)
 DBGM 202015008613
 DE-Patent Nr.: 10 2009 005 172
 EU-Patent Nr.: 2 208 430

Rolleppo is a challenging movement device that promotes physical movement and combines activity with a sense of achievement, which the children themselves can quickly and easily check. The smooth-running plastic wheel is connected via an axle to the guide rod, made of hard-wearing aluminium. With an egg-shaped handle made of solid beech wood it is rolled and guided over the floor. The connection is made either via a hole bore - this is easier and suitable for small children - or via an open fork - this is more difficult and suitable for older children, teenagers and adults.

In both difficulty levels, the objective and challenge is to guide the wheel over the ground - without losing it!

- Plastic wheel with rubber tyres for low-noise playing
- Anodized, hard-wearing aluminium guide rod, adjustable from 79 - 99 cm
- Haptically pleasant handle made of beech wood
- For children from 4 years, teenagers and adults
- Made in Germany
- For free game, single game
- For parcours running, obstacle running and competition games, pair and group games

- **Learning values:** Coordination, movement planning, movement control, body control, adroitness

1014020

Rolleppo® anthracite / yellow

1014025

Rolleppo® violet / yellow

1013650

Jakobs' Figure 8

Exercising with Figure 8 is activating both hemispheres on crossing midline and coordinating pressure of both hands. Coordination and cooperation of the right hemisphere and the left one were practised in a playful way. The ball should move as steadily as possible around the track, in turn counter clockwise top left or clockwise top right. The head always keeps straightforward - only the eyes do follow the movements of the ball.

Made of lightweight plastic with 6 rubber balls, 38 cm, weight 340 grams, to be wiped down with a damp cloth and/or with a germicidal wipe. For one or two children from 4 years up.

- **Learning values:** Fine motor skills, eye-hand-coordination, left-right-coordination, senso motor skills, communication, concentration, adroitness, improvement of learning aptitude, reduction of physical pressure, relaxation, activating the outer field of vision, basic literacy.

- **Range of use:** play and education, school, therapy, rehabilitation, senior-care

Jakobs' Figure 8



Original GymTop Therapy Top and GymTop Contura

Therapy tops made of high quality molded plastic, produced in blow-technique, tread surface or contoured surface for secure hold, color red, for persons up to 120 kg, extensive instructions in four languages. On request delivery in deco-box. 40 cm x, height 9 cm.

1010600

Original GymTop Therapy Top in decoration box

The GymTop is the ideal training-device to improve sense of balance, coordination and reaction with a great variety of exercises.

1010597 Original GymTop Therapy Top in decoration box

1010602

Original GymTop Contura Top

Lots of knobs are arranged uniformly on the surface, thus enhance comfortable stimulation and intensive and sensoric impulsion.

1010598 Original GymTop Contura Top in decoration box

1010605

TheraBeans

Training with TheraBeans is a method of high effectiveness for the whole muscular system of foot and lower leg, hand and forearm, its application is as easy as efficient. The specific part of the muscles is trained by a simple sequence of exercises without any risk of strain. Three components: The mechanical friction of the shifting beans, the two sizes tuned on each other and the smooth, rounded surface generate a resistance of almost neutral direction, i.e. during exercising there is hardly any phase of relief. Due to the comprehensive sensoric response TheraBeans are also well appropriate to be employed in the field of psychomotor and tactile perception. Hiding and searching pieces of a puzzle, marbles or other small objects between TheraBeans is fun. There are other games encouraging visual perception and fine motor skills as well, e.g. recreating patterns with TheraBeans, «goal flipping» or finding TheraBeans hidden in modeling clay.

Contents: Synthetic beans of polypropylene, mixture of 2 different sizes 20 x 15 mm and 13 x 9 mm, each size in both colors blue and gray, non toxic (food-standard), hygienically perfect, washable, suitable for disinfection packed in units of 5 kg in polybag = 8,33 liter (600 g = 1 liter), instructions with illustrative colored poster (for units of 15 kg minimum).

TheraBeans All Inclusive Set

30 kg TheraBeans with Acrylbox and 2 posters.

Acrylbox 40 x 50 x 40 cm, all up weight 38 kg.

Indications: muscle training, rehabilitation of muscle weakness, relaxation, stimulating blood circulation and lymphatic flow, improving metabolism, massage, exercises for sensomotoric

Field of application: therapy, personal therapy, rehabilitation, orthopaedics, neurology, sports training, psychomotricity, sensorimotor, massage, tactile and sensoric perception

TheraBeans®

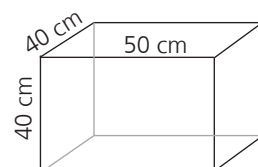

Original GymTop®



Contura®Top

GymTop®

Therapy Top



TheraBeans®



NEU

PHOENIX



Stapelstein PHOENIX
PHOENIX STARTER Set of 4 black
(further sets see product text)



Kreiselstein PHOENIX
black

produced from 100% recycle material



Balance-Set PHOENIX
1 Kreiselstein black + 2 Stapelsteine black

PHOENIX

"Like a Phoenix out of the ashes", this sustainable product line is made from 100% recycled material. PHOENIX is a statement for sustainable production, environmental awareness and minimalist design.

The reduction to pure form without colour accents focuses on versatile functionality. The neutral, timeless colouring is ideal for the fitness area and special therapy areas.

1511310 Stapelstein PHOENIX STARTER
Set of 4 black

1511311 Stapelstein PHOENIX BASIC
Set of 12 black

1511312 Stapelstein PHOENIX TEAM
Set of 24 black

1511313 Stapelstein PHOENIX 360°
Set of 36 black

1511314 Kreiselstein PHOENIX black

1511315 Kreiselstein PHOENIX BASIC
Set of 3 Kreiselsteine black

1511316 Kreiselstein PHOENIX TEAM
Set of 6 Kreiselsteine black

1511317 Balance Set PHOENIX
1 Kreiselstein PHOENIX + 2 Stapelsteine PHOENIX black

SAFARI is insensitive to dirt and is therefore particularly suitable for outdoor use. The unique design ensures long-term recognition. Each stacking stone has a unique dot structure and is therefore unique. This sustainable product line consists of at least 90% recycled material, 10% are coloured new material to enable colour play.

1511210 Stapelstein SAFARI STARTER
Set of 4 coloured

1511211 Stapelstein SAFARI BASIC
Set of 12 coloured

1511212 Stapelstein SAFARI TEAM
Set of 24 coloured

1511213 Stapelstein SAFARI 360°
Set of 36 coloured

1511214 Kreiselstein SAFARI blue

1511215 Kreiselstein SAFARI BASIC
Set of 3 Kreiselsteine SAFARI blue

1511216 Kreiselstein SAFARI TEAM
Set of 6 Kreiselsteine SAFARI blue

1511217 Balance Set SAFARI
1 Kreiselstein SAFARI blue + 2 Stapelsteine SAFARI blue

NEU

SAFARI



Kreiselstein SAFARI blue



Stapelstein SAFARI
SAFARI STARTER Set of 4 coloured
(further sets see product text))

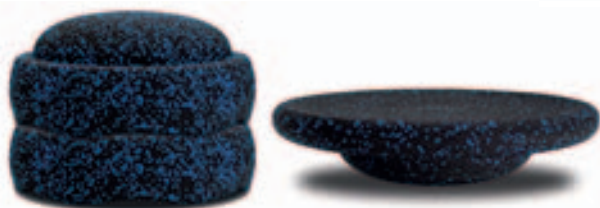

Balance-Set SAFARI
1 Kreiselstein SAFARI blue +
2 Stapelsteine SAFARI blue

Stapelstein SAFARI BASIC
Set of 12 SAFARI coloured



Stapelstein

The Stapelstein is an innovation! The Stapelstein is a multi-functional, stackable object that is used intuitively and creatively by children. The unusual texture provides more movement when sitting, learning, playing and balancing. Seating circles can be formed quickly and easily or an individual stool can be stacked! So both children and adults sit naturally and close to the ground.

Playing and building with the Stapelstein playfully conveys a feeling for heights, distances and spatial location - especially when it is built into life-size play worlds or movement paths. At the same time, motor skills such as balance and coordination can be trained at different levels of difficulty: Stapelstein at different heights and at different distances. Two Stapelsteine stacked on the undulating side create an exciting wiggle with new movement requirements and challenges.

- Production in Germany
- Light, stable and harmless material (particle foam)
- Saves up to 96% of the resources of conventional plastics production
- Durable, easy to clean and waterproof
- Suitable for indoor and outdoor use
- Dimensionally stable from minus 10 degrees to plus 100 degrees
- H 12 cm, Ø 27cm, weight 180g, loadable up to 180 kg
- For children from 12 months
- Available in 4, 12, 24 and 36 sets
- Free app "Stapelstein" with application examples and game ideas
- Bag suitable for 12 Stapelsteine and 1 Kreiselstein available separately

1510101 Stapelstein CLASSIC STARTER
Set of 4 coloured incl. app

1510501 Stapelstein CLASSIC BASIC
Set of 12 coloured incl. app

1511000 Stapelstein CLASSIC TEAM
Set of 24 coloured incl. app

1511001 Stapelstein CLASSIC 360°
Set of 36 coloured incl. app

1519501 Bag for set of 12

Kreiselstein

The Kreiselstein is ideal for active balance training, movement coordination and dynamic sitting. In combination with the Stapelstein, height and difficulty can be changed. The raised edge of the Kreiselstein provides additional support during demanding exercises. The very light material feels particularly pleasant and warm, is sound-absorbing and makes no noise during use. The Kreiselstein can also be used as a foot-leg-axis trainer when turned upside down. Suitable for children and adults.

The Kreiselstein is available individually, as a set of 3 or 6 in the colours red or blue.

The Balance Set consists of a Kreiselstein and two Stapelsteinen, each in the colours red or blue.

- Light, stable, harmless, non-slip material (EPP)
- 270 g, loadable up to 180 kg
- H 8 cm, diameter 35,5 cm
- From 3 years: for children, teenagers and adults
- Made in Germany

1510003 Kreiselstein CLASSIC blue

1511114 Kreiselstein CLASSIC red

1511115 Kreiselstein CLASSIC BASIC blue
Set of 3 blue

1511116 Kreiselstein CLASSIC TEAM blue
Set of 6 blue

1511117 Kreiselstein CLASSIC BASIC red
Set of 3 red

1511118 Kreiselstein CLASSIC TEAM red
Set of 6 red

1511119 Balance-Set CLASSIC blue
1 Kreiselstein blue + 2 Stapelsteine blue

1511120 Balance-Set CLASSIC red
1 Kreiselstein red + 2 Stapelsteine red

CLASSIC



Kreiselstein CLASSIC blue



Kreiselstein CLASSIC red



Stapelstein CLASSIC
CLASSIC STARTER Set of 4 coloured incl. App
(further sets see product text)



Balance-Set CLASSIC red
1 Kreiselstein red + 2 Stapelsteine red



Stapelstein CLASSIC 360°
CLASSIC Set of 36 coloured incl. App
(further sets see product text)



App "Stapelstein"

The App "Stapelstein" for free download for all Stapelstein CLASSIC Sets
(The app can only be used on IOS devices)

More information at www.jakobs.de/Stapelstein/

The App Stapelstein - guide and key to the holistic physical activity and competence-oriented motion promotion. The concept addresses basic needs of children and educators, creating a common space for enjoyment of exercise, play and learning. The App gives impulses and suggestions, motivates and supports the daily work with children. Qualified applications which are developed in cooperation with experts from different educational areas promote the motor, cognitive, social and creative competence of children.





Rotonda® Juggling Hat



VIDEO



1010369

Rotonda Juggling Hat

Rotonda is a play-, training- and juggling-device and is especially challenging. When the ball (optimally a foam rubber ball) is getting in a circular motion, the player can vary the ball's effect differently. What happens when fingers are held together or are spread apart, or there is a change of speed or direction through movements of the hand? Rotonda is always demanding and offers different kinds of difficulty. Experiencing physical relations of gravity or acceleration, encouraging eye-hand-coordination, proprioceptive perception, attention, coordination, skills and activity. Let the ball being rolled alongside the upper edge and holding it there or using Rotonda for throwing and catching (air-filled balls are appropriate) are offering additional ways of playing and a challenge and fun at the same time. Rotonda d20cm with 3 balls (foam rubber ball 5,5cm, air-filled Freeball d3cm and d5cm), incl. manual. For Children from 4 years up; teenagers and adults being in therapy.

1013660

Rondogo Ball Carousel

(based on an idea of Klaus Kühl)

The new active game Rondogo Ball Carousel is a fascinating and challenging device. Place Rondogo Ball Carousel on a flat surface and put the chosen ball inside the ring. Hold the handles with both hands and try to set the ball in a radial running by smooth circular motions. Then lift up Ball Carousel from the surface and marvel at the «bottomless» ball which is rotating in mid air. Three different balls provide diverse variants of the game. For 1 or 2 players. Ideal in combination with certain motion requests. Playful training of motor skills, which improves positive feedback by self-perceptible control of success.

Manufactured in Germany, made of high quality and durable plastic material. Incircle 36 cm Ø, outer circle 48 cm Ø, dimension with grip moulds 56 cm, height 9 cm. Delivery with 1 moss-rubber ball, 6 cm Ø, 1 air filled ball, 5 cm Ø, 1 playpen ball, 6 cm Ø. Suitable for children from 5 years of age, incl. instruction.

Learning values: Body tension, concentration, eye-hand-coordination, adroitness, proprioceptive perception, persistence, activation of both brain hemispheres by crossing the body centre.



VIDEO



Rondogo® Ball Carousel



Fluttering Ghosts

Fluttering ghosts give a fresh impetus to each group. Holding a «ghost» with the rod in one hand and the cord in the other hand (at ease). Moving the rod through the air, length of cord can be controlled by dragging and dropping. Due to the balls' and scarf's own weight the «Fluttering ghost» gains momentum. The ghost soars, hovers, falls, 'dances' on the spot and is portraying fascinating figures in the air. It trains through fun and games (eye-hand-) coordination, following motion sequences with eyes, attention and encourages moving around, creativity and interaction. For children from 3 years upwards; teenagers, adults and elderly people being in therapy. Available separate or as a set of 3 including green «Forrest-spirit» red «Fire-spirit» and blue «Water-spirit» consisting of one foam rubber ball, chiffon-scarve, plastic rod with cord; length ghost 40cm, length rod 40cm, length cord 120cm.

1010360 Water Spirit

Fluttering ghost with blue chiffon-scarve and blue cord.

1010361 Fiery Spirit

Fluttering ghost with red chiffon-scarve and red cord.

1010362 Forest Spirit

Fluttering ghost with green chiffon-scarve and green cord.

1010365

Fluttering Ghosts in a Set

Water Spirit, Fiery Spirit and Forest Spirit in a set to create imaginative activities in a group.

Fluttering Ghosts

VIDEO

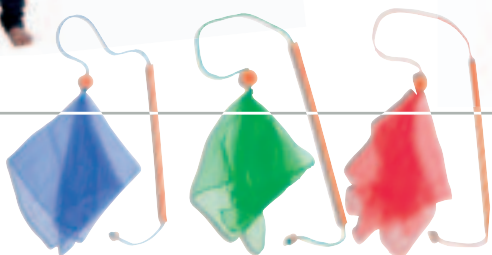

Water Spirit Forest Spirit Fiery Spirit

Rolletti Rolling Boards

Rolling boards are essential motion toys and training-devices for children. Games of skill, racing or group plays can be carried through sitting, lying or kneeling. You can realize great ideas for playing, like linking several Rollettis together with a rope to a ‚Rolletti-Fun-Train‘.

Rollettis

Rolletti rolling board, 63 x 40 cm, birch-plywood, varnished in blue or red, round-shape corners, practical handles inside the board for hand protection, special, highquality wheels with long-wearing surface and triple ball-bearings that make them run smoothly.

1400816 Rolletti Rolling Board blue

1400817 Rolletti Rolling Board red

Maxi Rolletto

Oversized rolling boards! Each rolling board has on its short side two practical handles for holding and hand protection. The four slots around the board are for connecting the boards together: Easily connected with the velcro-tapes, either side by side to have a Big Rollettoraft or one after another to have a Big Rolletto-train for new challenging motor activity games. Up to 8 children can exercise coordination, cooperation and adroitness and proof teamwork. The low gravity point provides high stability, also available as a single rolling board..

Ultrafoam Scootaddles

Each paddle comes with a sturdy cushioned handhold for comfortable and easy use along with maximum control without prompt exhaustion and has a sturdy hard foam-ball at the shaft’s end.

1072088 Ultrafoam Scootaddles set of 12

Includes 12 paddles (2 x 6 colors), length 87cm, 3 No-Bounce-Balls, 6cm diameter.

1072151 Ultrafoam Scootaddles set of 4

Includes 4 paddles (2 x 2 colors), length 87cm, 1 No-Bounce-Ball, 6cm diameter.

1014015 Maxi Rolletto Set of 4

2 red and 2 blue Big Rollettos, 4 velcro-tapes and a 3 m rope to pull the boards. Each single one has the measures 73 x 48 cm, made of birch-plywood, 15 mm thick, varnished in red or blue, round-shape edges and triple ball bearings that make them run smoothly, each board for maximum weight up to 120 kgs.

1014013 Maxi Rolletto red

Giant Rolling board, red, 73 x 48 cm.

1014014 Maxi Rolletto blue

Giant Rolling board, blue, 73 x 48 cm.

Rollettis



suitable on all smooth floors indoors



Scootaddles



Maxi Rolletto Set of 4



Maxi Rolletto red and blue





**Bucket stilts
NATURE**

10,5 cm

12,5 cm



13,5 cm

1011340

Bucket stilts NATURE

Stable pot stilts made of sustainable, environmentally friendly material, which is made from renewable raw materials. The WPC material (natural fiber reinforced plastic) has a certified wood content of 50% and conditional the natural, irregular coloring.

1 pair pot stilts, height 12.5 cm, diameter 13.5 cm, with installed hemp cord and handle made of WPC material. Pot stilts promote coordination, sense of balance and body control.

1010390

Throwing Game RETRO

Distinguished by distinct, simple forms and high quality material plus valuable workmanship. Ordinary and well known play principle can be adjusted according to skills and ages of players. Wooden stand is raised, haptic and appealing quoit is to be thrown from any random distance. The quoit is segmented in three, varyingly big sections. The engraved numbers indicate the various scoring sections. Stand and quoit made from multiplex birch, coated with clear varnish, quoit Ø 33 cm, 6,5 mm thick; stand Ø 25,5 cm, 30 cm high. Made in Germany. For 1-4 players, for children from 4 years of, teens, adults and elderly.

1010851

Viking-Game (Kubb-Game)

Classic wooden outdoor-game from Gotland for lawn or sand, 2 to 12 players, children and adults. Includes 10 logs of wood (called Kubbs), approx. 5,5 x 5,5 x 12cm, 1 king 7 x 7 x 24cm, 6 throwing-sticks (approx. length 30cm) and 4 field-markers with which a field of about 5 x 8m or 8 x 10m is defined.

2 teams are established. It is the goal to overthrow all of the other team's Kupps, beginning by throwing from the own baseline, later throwing (underhand-throwing!) from advanced positions and to aim at the king at last.

The highly competitive characteristics as well as strategical moves (lawn-chess) make this parlor game a challenging, exciting and interesting experience. Comes in a sturdy cardboard box, extensive instructions and rules included, 5kg.



**Throwing Game
RETRO**



Viking-Game



Mini-Soccer Goals

Mini-Soccer Goals are football-goals for children and teenager of any age bracket and are successfully deployed in football-clubs and youth work, adequate for any outdoor-floor.

- Ceiling made of impact and uv-resistant PVC- plastic profiles (in accordance with REACH)
- In different consolidations depending on the goal-dimensions
- Corner connections made of impact resistant Polypropylen
- Delivery complete with strong nets, net-hooks, anchorage and carrier bag for transportation and storage
- Easy assembly and disassembly, taking only a few minutes. Assembly-instructions included

4356016 Mini-Soccer Goal 16 Set

The set provide a new and practical function: Depending on the number of players or the training matter the gamer can focus on either one large or two smalls goals.

- Construction kit for 2 goals (w 130 x h 100 x depth 75 cm) or
- Construction kit for 1 goal (w 180 x h 165 x depth 100 cm)
- Plastic profiles 22 respectively 25 mm strong
- Overall weight approx 8,5 kg.

4356019 Soccer Goal 19

Construction kit for a soccer goal of two different sizes:

- Goal-size A 366 cm x h 183 cm or
- goal size B 244cm x h 183 cm
- Plastic profiles 53 mm respectively 68 mm strong
- Overall weight 17,7kg

1010375

Fußballgolf

Soccer Golf in a very different way, but still thrilling and challenging! The goals are mounted with hook-and-loop fasteners to the carpet – just yet the game can start. Each player gets a racket, upon a foam rubber ball is mounted with a cord. The rubber balls act as the hitting surface and should hang slightly above the bottom. By doing a back-swing each player tries to hit the game ball with their own rubber ball and tries to move the game ball towards the opponent goal. Soccer Golf is delivered with three different play balls, which distinguish each other in shape, size, and weight and play features, so that level of difficulties and challenges are given. More play variants are possible.

- 1 football mat 150 x 100 cm made from durable, tufted material
 - 2 wooden goals
 - One dice ball (12-sides and 2-coloured), one rubber ball 85 g, one Freeball (air-filled)
 - 4 rackets with strike-ball
- For 2-4 players, for children from 4 years, teens and adults. Incl. play instruction.

• **Learning values:** Fine motor skills, force-adjustment, physical feeling, instinctive feeling, eye-hand-coordination, endurance, interaction, capacity for teamwork

• **Range of use:** Play, didactic and education, therapy, indoor game



2 Tore / goals
130 x H 100 cm

Mini-Soccer Goal 16 Set

Kit for 2 goals
(W 130 x H 100 x D 75)

or

kit for 1 goal
(W 180 x H 165 x D 100)



1 Tor / goal
180 x H 165 cm



366 x H 183 cm

Soccer Goal 19



244x H 183 cm

Fußballgolf



Fußballgolf

Only
in
German



Concentration exercise
by controlling
ball & rod

Relaxation exercise
reassuring and
focusing on content
of lessons



Coordination exercise
to connect both
hemispheres
of the brain

Endurance exercise
for work out,
stimulation of metabolism
and waking up

**KEA - Display stand with exercises for school lessons
"Concentration - Relaxation - Endurance"**

Many pupils - and consequently also teachers - know this: Concentration and fatigue during a school day, independent class or age group and often in the middle of the classroom. Exercises as shown in the KEA stand can solve this problem and support, reinforce and improve concentration and absorption capacity. There are 50 exercises in the areas of concentration, relaxation, coordination and endurance, for in between or at the beginning of a school lesson, make tired students awake. 20 exercises are performed with wooden rods and foam rubber balls. The execution of the exercises does not require any previous knowledge of students and teachers. Students receive immediate feedback on their exercise execution.

The DIN A4 table display stands are placed on the teacher's desk - visible to all pupils. The execution of each exercise is explained in a short description and takes a maximum of one minute. The individual movement units can be arranged individually according to time and need by varying the length and exercise selection.

Many scientific studies show that exercise has a measurably positive influence on learning processes in children and adolescents as well as adults. Physical activity enables interconnections in the brain that lead to an increase in brain activity and thus to higher cognitive performance and maintain it for longer. Movement breaks in the classroom are an important and effective learning support. In short: Exercise wakes you up and helps you learn.

Field of use: School, Didactics/Education, Therapy, Seminars, Workshops

1000860

KEA - Display stand with exercises for school lessons

Stand in DIN A4, landscape format, 58 pages, 300g/qm, metal spiral as wire-O-binding. For 1-30 students.

1000865

KEA - Set • Stand with exercises for school lessons & set of 6 wooden rods and foam rubber balls

Stand in DIN A4, landscape format, 58 pages, 300g/qm, metal spiral as wire-O-binding. 6 rods made of solid beech wood, 22 cm, 6 foam rubber balls 6 cm Ø.

1000862

Rod-Ball Set of 6

6 rods made of solid beech wood, 22 cm, 6 foam rubber balls 6 cm Ø.



1072027

Educational Dice

Ultra Light and Ultra Safe! Teamwork, cooperation and coordination. Use this ball to develop individual skills and to play non traditional games. Easy to handle due to its size and lightness, it is the perfect tool to develop imagination and creativity. You can roll the ball, pass it and move it as a team, make a tag game by touching players with the ball, keep your balance on the ball with the help of teammates. Play giant volleyball or other more competitive games. Ultra Ball has a water-resistant coating that both strengthens and increases the versatility. It is lightweight, and can be tossed, even kicked, indoors or out. 120cm diameter, comes with one latex bladder.

Movecubes

Lightweight cubes made of foam with a vinyl coat in gymnastics-mat-quality. Each side features a clear plastic wrap in which fits individually written-on cards, Different motion-demands are being written onto the cards – jump, run, hop, stretch, balance etc. Six different demands per cube are optional, keeping the children in motion - mentally and physically. Motor activity, communication-games and memory games, even in the integrative area and for work with elderly people, can be combined with concentration- and memory-trainings. A playful appeal is always in focus. Each cube-side in a different colour.

1072221

Movecubes Mini, set of 6

For photos or image-cards up to a size of 11 x 16cm. Cube-size 17cm x 17cm, weight 100g.

1072069

Movecubes, set of 3

For photos or image-cards up to a size of 11 x 16cm. Cube-size 17cm x 17cm, weight 200g.

1072244

Set of 6 Pyramid Beanbags

These bottom-weighted, pyramid-shaped beanbags are great for all types of throwing activities as they provide a better grip and more tossing control since they easily fit in the palms of students' hands! They are also ideal for juggling activities. Thick cotton cover. Come in a set of 6 bright colors for easy class organization.



Educational Dice

Movecubes Mini Set of 3

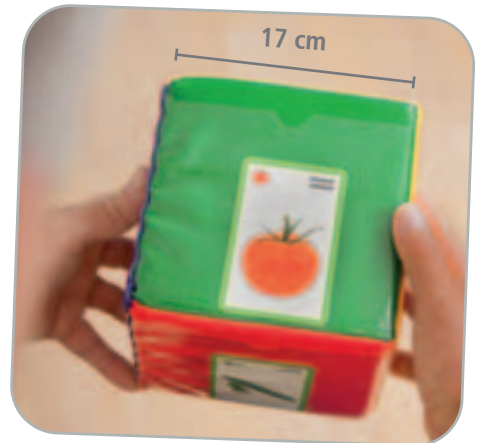

Movecubes Set of 3



Set of 6 Pyramid Beanbags



Pursuit Ball



1072128 Pursuit Ball - 2 Teams

In 2-Team Pursuit Ball, students can play a cooperation game where teammates attempt to work together to gather their own color ball the quickest. In competition mode, teams try to put their team color balls into the other goal while their goalie maneuvers to avoid them. There are many opportunities for children to self-guide the play or make new games and rules. The set includes: two goals, 10 balls per goal (20 together) and a detailed activity guide.

Teamvests

Color-intensive vests made of 100% nylon for all team- and competition-games. The wide, elastic rubber waistband is coated and led through a durable sewn hem-ending. For small children, Length ca. 52 cm, width ca. 30 cm.

1072131 Teamvest large yellow

1072132 Teamvest large red

Foldable aluminium goals

Goal structure made out of 38mm aluminium. Goal can be assembled and disassembled in less than 15sec. Suitable for in- and outdoor use. Delivered with net.

1072200 Foldable aluminium goal small

120 x 80 x 60 cm, 15kg

1072201 Foldable aluminium goal large

155 x 95 x 75 cm, 19kg

Teamvests



Super SoftTouch Footballs (Max-Balls)

Inflatable balls with needle valve, for all age brackets, for in- and outdoors. The SoftTouch footballs match the norm concerning their jump- and roll-characteristics. The additional surface adhesion due to the textile-like structure enables better control and thus enhances the chance of success. Appealing football-look in a visible bright yellow with red and blue pentagons, for any ball-activities.

1072035 Super SoftTouch Football 4 (Max-Ball, 21cm Ø, wt. 340 g)

1072036 Super SoftTouch Football 5 (Max-Ball, 23cm Ø, wt. 420 g)

1072215 Junior Foam Football

Very soft and highly resistant foam football ideal for very young children. Ball diameter: 12cm, weight 110 g.

Super-Safe Balls (PG Balls)

Inflatable foam-vinyl-balls with needle valve, manufactured without stitching. The ball's skin does not peel and is water-resistant. Bubbles enclosed into the vinyl support the extraordinary cushy tactile surface-effect. Size and playing-abilities can be adjusted on demand by inflation or deaeration. For all age brackets, indoors. Super-Safe-Balls are inexpensive injury-proof training-balls and an alternative to common flexible foam balls. The exceptional manufacture-technique makes them extraordinarily skidproof and extremely durable. Suitable especially for indoor sports, training, practice and advancement of diverse playing-techniques.

1072061 Super-Safe Ball PG Football, 20 cm diameter

Neon-yellow football, 21,6cm diameter, weight 250g, in typical black-yellow soccer-design and clean surface.

Foldable Aluminium Goals



Super SoftTouch Footballs



Ball 5



Ball 4

Junior Foam Football



12cmØ

Super-Safe Ball Football



20cmØ

1072239

Indoor football soft gliding foam half

You no longer have to worry if the kids want to play football inside with this smooth half football gliding on the floor. If you are looking for safe fun inside or accuracy training this ball is the ideal product. The half football is made of soft foam and has a disc on its underside that enables it to glide easily on almost any indoor surface and to stay on the ground. This ball also glides on a table and can be interesting for disabled people as well. Size: 7,5cm (H) x 15cm (L).



Indoor football, half



1072234

Hurdle, adjustable

This Adjustable Hurdle is perfect to strengthen the overall physical condition but also to work on the amplitude of movement and on rebound. This hurdle is also a great tool to initiate hurdle races. B 46 cm, H 16/23/30 cm.

1072235

Mini air compressor

Light and compact oil-less air compressor with gauge. Delivered with 1,5m air hose and four different needles. 20 x 12 x 16 cm, weight 2 kg.

1072237

Volleyball light XL

Thanks to the fact that this volleyball is 25% larger and at the same time 40% lighter than a regulation size volleyball it makes it the perfect ball to learn how to play volleyball without any fear. Its synthetic-leather surface allows the ball to rebound which is ideal for volleyball initiation exercises.

1072218

Super Safe Contact Ball

This lightweight ball is very soft and safe. Particularly adapted for traditional games like dodge ball where the aim of the game is to eliminate the opponent by touching him with the ball. The ball contact is totally safe thanks to the slower ball movement and the soft skin impact. When not totally inflated, the ball is very easy to grab and does not roll away since the shock is absorbed by the ball. When totally inflated, the ball turns into a regular SuperSafe play ball with rebound. Soft vinyl (phthalate free PVC) construction filled with pellets (EPS foam). Ø 15cm, weight 150g.

1072075

Super-Safe Balls PG Playground, 21,6 cm diam., set of 6

6 Playground balls with extra skidproof surface-structure. 6 colors red, blue, yellow, green, orange and purple, 21,6 cm diameter, weight 270g.



Hurdle, adjustable



Mini air compressor



**26cmØ
Volleyball light XL**



Super Safe Contact Ball



15cmØ

Super-Safe Balls set of 6 21,6cmØ

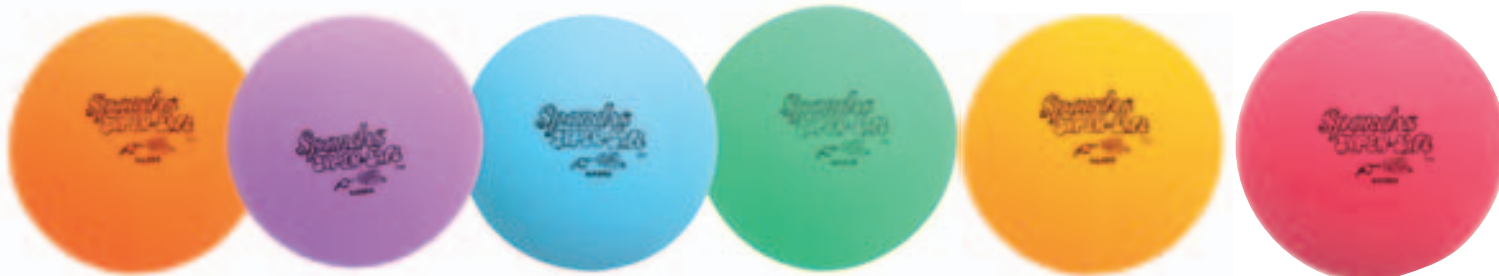



Hula Hoop Target Set

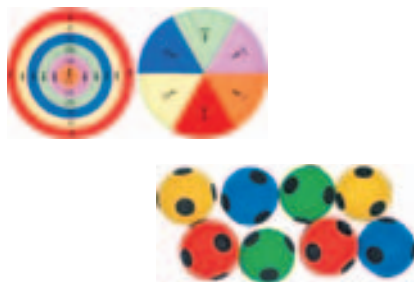

1072028

Hula Hoop Target Set

If you have two 76cm hoops, you have two target at a price that any budget can afford. These targets can be hung on a wall or used on the floor to teach young children how to throw underhanded with any soft ball. It only takes a second to put the target around the hoop and even quicker to remove. Delivery without hoops, wooden gym hoop see page 135).

1072029

Hula Hoop Cover Set

2 covers suited for hoops from 76-80 cm.

1072030

Soft Hook-N-Loop Balls

8 soft Balls in colours of red, blue, green and yellow. Each ball has 6 Velcro-points to hook up, 7 cm Ø.

1072196

Giant Catch Tail Balls set of 2

After the succes of our Tail Ball we are introducing its big sister: the Giant Catch Tail ball is made of a high quality soft foam ball in a mesh covered bag. This ball improves throwing skills since it enhances eye-tracking and catching and is therefore especially a great choice for young children. Total length: 91,4cm; Diameter of foam ball: 6,4cm.

1072079

Super foam Ringz set of 3

The lightweight rings are suitable for juggling and throwing and behave steady in both vertical and horizontal course. The two colors of each ring always are a primary color combined with its accordant complementary color (3 color combinations).

Ring-diameter 35,5cm, singular weight 230g. 2 plastic rings made of fracture-proof tube-material, approx 3cm diameter, coated with soft, slip-proof foam, providing safety at throwing- and catching-games

1072065

Poco Ball

Vinylball, approx 7cm diameter, weight 80g, with a colorful detachable textile-tail. For children of 3 years and up, perfect for group- and dancing activities.

A ball for throwing, catching, hopping, juggling and skidding. Like a small comet it flies through the air impressively and is easy to catch at its tail.

1072157

Pebble™ Sailors Set of 6

Pebbles texture (from which it gets its name) makes even big products small-handfriendly. Their ball-size foam-filled rims make them easier to catch and easier to throw than other flying disks. Diameter 15cm, single- weight 160g.

Giant Catch Tail Balls set of 2



Super foam Ringz Set of 3



Poco Ball™



Pebble™ Sailors

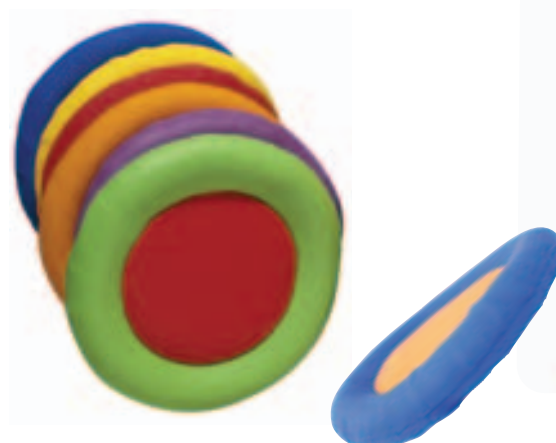

1072078

Beanless Airbags, set of 6

6 quadratic plastic bags in the set-colors yellow, blue, red, green, orange, purple, 12,5 x 12,5cm, with needle valve for inflation and deaeration. Due to the special weight, Beanless Airbags can be thrown and caught just like BeanBags. The more air is filled in, the more pronounced are the ball's characteristics, which feature highly momentum jumping characteristics as a result of its 4 edges. When just lowly air-filled, the airbags are flattened and are adequate for balancing games and exercises with different demands. Separate weight 88 g.



Beanless Airbags set of 6



1072051

Safer PogoBouncer™

Durable platform made of layered, foam-like rubber, 26 x 13 x 8 cm, with a latex-rope anchored into the foam. The handhold is foam-coated. Overall height 77 cm, weight 2,5 kg. The PogoBouncer has been designed especially for use in kindergarten and school. The material guarantees excellent jumping-characteristics. Psychomotricity-device for manifold dexterity- and coordination-activities.

Safer PogoBouncer™

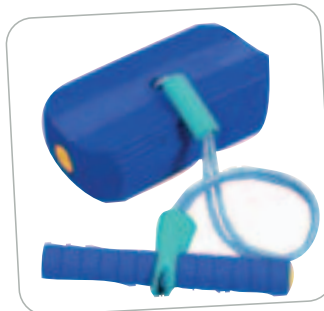

1072219

Soft Weighted Hula Hoop

This large and very durable Hula Hoop ring is covered with high density, soft foam in rainbow colors. Thanks to its bigger size it is easier to work out with. Its heavier weight helps slim and tone the body's core muscles, while the high-density foam padding provides extra protection against discomfort. So much fun to exercise waist muscles and enhance movement skills. Assembly and disassembly for easy storage and comes with a storage bag. Suitable for ages 10-18. Ring diameter: 75cm. Weight: 600g.

Soft Weighted Hula Hoop



1072223

Badminton Racket (one piece)

Very small and very light racket ideal for young children but also perfect for people with less strength. Aluminium head with tempered steel flat shaft. Weight 80g, length 47,5cm.

Badminton Racket



1072224

Badminton Shuttlecocks

Tube of 12 very light, PVC shuttles in 4 highly visible neon colors. Ideal for badminton initiation and young children. 7,5cm.

1072225

Portable Badminton Net

A lightweight portable badminton/ mini tennis net kit that can be set on any flat ground (grass, gymnasium, concrete etc.). The net is 5 meters wide which is the size of regular badminton single court. Very easy to assemble and disassemble. Sturdy steel poles of 1,55m tall and with a 19mm diameter. To use for badminton, just raise the end side poles. To use for mini-tennis, lower it down. Comes with a convenient carry-on bag (90cm long). weight 2,54kg.



Badminton Shuttlecock set of 12



Badminton Net



SpiderBall

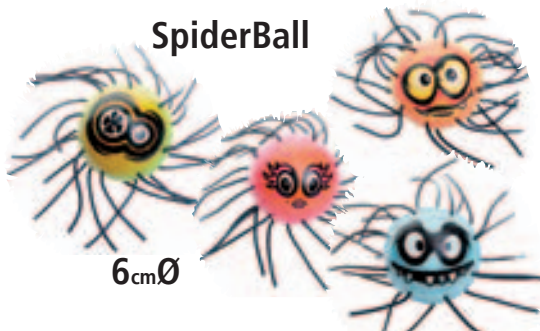

6cmØ



1072062 SpiderBall

Rubber ball, approx 6cm diameter, with 6cm long tentacles, weight 80g, also adequate for work with handicapped persons.

An extraordinary, strange-looking ball which persuades by its function. The tentacles alleviate catching and equip the ball with a unique ability: braking! That means that it does not roll far away in case that the child does not catch the ball. Coaches motor skills and amplifies the appeal of different throwing- and catching-games.

Pom Pom Ball

Extraordinary ball with countless soft, colorful tentacles made of fine rubber threads causing unequal tactile characteristics. Additionally they bolster every bounce so that the ball stops immediately instead of hopping and rolling further. Children can easily catch and hold it. Available in two sizes.

1072083

Pom Pom Ball 75 mm

75mm diameter, weight 50g.

1072187

Pom Pom Ball 100 mm

100mm diameter, weight 80g.

Pom Pom Ball



75mmØ



100mmØ

Surekatch Ball

11cmØ



1072067 «Surekatch»Ball

This extraordinary ball is pretty easy to throw and as easy to catch and so exceptional that it is appealing even to youngest children. The playing is always motivating. Self esteem and self-confidence are strengthened by success regardless of individual abilities.

Supports the advancement of eye-hand-coordination and motor skills. Colorful ball with patented ABS-plastic-loops, approx 11cm diameter, weight 40g. For all age brackets in- and outdoors.

(On delivery the loops may be narrowly aligned due to storing-circumstances; straighten up when in use.)

RubberFlex GrabBalls

The RubberFlex Technology makes it possible to manufacture these balls of one piece, soft and flexible, but even though nearly perfectly round, dimensionally stable and durable. For all throwing-, catching- and rolling-ballgames indoors, in 3 sizes.

Due to their unique structure, the GrabBalls can be thrown, caught, bowled and rolled in numerous ways – even with just one finger! Possibly the world's most simple ball with functional ball-characteristics.

1072220

RubberFlex GrabBalls 6er-Set - 9 cm Ø

Weight 35g per ball

1072042

RubberFlex GrabBalls, 12cm diameter, set of 6

Weight 100g per ball

1072043

RubberFlex GrabBalls, 21,6cm diameter, set of 6

Weight 450g per ball



RubberFlex GrabBalls™ Sets of 6

9cmØ • 12cmØ • 21,6cmØ



1072238

Fluff Balls, 7 cm, set of 12

Fluffballs are light and very easy to throw, to catch or to handle. Thanks to their soft fluffy texture, these balls definitely eliminate any risk of injury. Furthermore, Fluffballs never roll away on hitting the ground, as their texture just absorbs the impact. Moreover, you won't hear any noise when playing with Fluffballs. Ideal for hand exercises and racket or paddle games. Ø 7cm. Age: 3+.

Fluff Balls, set of 12



7cmØ



1072199

Emotional Faces 20cm - Set of 6

These colored balls represent 6 different emotions of human's lives. Funny to use, especially for younger children.



**Emotional Faces
20cm - Set of 6**

FingerLights

Super strong surface resists punctures! Each pair comes in purple and green. Bounce off virtually anything, even an extended index finger!

Regardless of their physical abilities, FingerLights make everyone in the room a participant. That is because when fully inflated they are so responsive that their polyurethane (PU) panels will first stretch around the surface they hit (a finger, a nose or the top of a head) and then rebound off it. They are so light that they will literally float on a room currents like bubbles. While we'd have trouble guaranteeing a bubble for more than 2 minutes; the unique PU panels and solid welds are so strong, we guarantee them for 2 years. FingerLights are sold in pairs, one each of translucent green and purple.

1072172 FingerLights 1 Pair Ø 25 cm

1072173 FingerLights 1 Pair Ø 35 cm



35cmØ

25cmØ

FingerLights

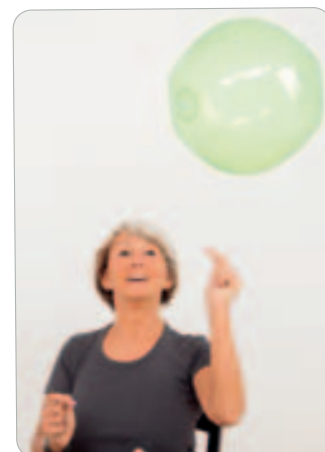

1072163

Sensation Ball

Transparent ball with two small hard plastic balls inside. As they roll, the user hears them while simultaneously seeing them. As an added measure of fun, the inside balls act as eccentric weights making the ball's roll and bounce slightly erratic and unpredictable. Suitable as water-ball. Diameter: 17,8cm. Weight: 90g.



Success Ball Sets of 6 in 2 sizes

We bring you the absolute best; easy-to-see, fun-to-touch, easy-to-grasp, tactile balls you have ever laid your hands on. Watch your children touch and learn with delight! Made of EVA-foam pellets surrounded by LYCRA® and mesh panels, these balls are the easiest to grab. Impact is absolutely painless. Floats in water!

1072154 Success Ball Set of 6 • 13 cm Ø

1072103 Success Ball Set of 6 20-21 cm Ø, weight 160 g

Sensation Ball

17,8cmØ



**Success Ball™
Sets of 6 in 2 sizes**



13cmØ



20-21cmØ

RhythmFLAGS



50 cm

RhythmFLAGS

The RhythmFLAGS are made of high quality smooth nylon and feature stitched-in BeanBag-granulate in one corner as well as a slewable loop. Flags come in different colors (3 primary, 3 secondary colors) and in two sizes for boys and girls of 4 years and up. Handling the slewable loop, the flags are easily set into motion, furthermore they fall clean and pretty like they do when operated by skilled flagswingers. It brings fun and motivation! The BeanBag-weight always holds the flag behind the swinger and amplifies the swinging-sound. Children as well as teen-agers can mold creative and imaginative motion-pictures. They can arrange interesting rhythm- and dance-groups and much, much more.

1072055

RythmFLAGS set of 6, 50cm, 70g

6 Flags in red, blue, yellow, green, orange and violet colors. This size fits for younger children in particular.

1072056

RythmFLAGS set of 6, 70cm, 110g

6 Flags in red, blue, yellow, green, orange and violet colors. This size fits for older children and teenagers.

Two-Person Parachutes



1072216

Two-Person Parachutes

These sturdy, Two-Person Parachutes bring a unique element of cooperation and teamwork tossing and catching. They may also be used in rhythm and dance for partnering activities as a way to join together without holding hands. Made from sturdy ri-stop nylon with strong webbing handles on each end, each chute measures: 83 cm x 127 cm Set of 6 colors

1072084

Parachute Pack

Everything needed for interesting and varied games with the parachute is included in this accessories set (weight approx 2kg):

- 6 BeanBag Frogs (6 different colors)
- 6 E-Z balls, 10cm diameter
- 12 All Play playing-balls, 10,2cm diameter (balls with slowed jump- and flight-characteristics)
- 2 extra steady beach balls, 20cm diameter
- 1 netbag for storage and transportation

1072066

E-Z Balls, set of 6

E-Z Balls are soft and handy, the surface with its enclosed hatches has a comfortable soft touch. Nevertheless these balls show excellent jumping characteristics and support diversified active playing. Sturdy, durable foam, approx 10cm diameter, assortment of 6 colors. For all age brackets, in- and outdoors. Weight 80g per ball.

All Balls set of 6



Parachute Pack



E-Z Balls

10cmØ



1072054

Mono-Fling, set of 2

Funny and interesting ball-catching-game which can be played in teams – like volleyball or badminton – without a large net or by one person. Of course existing balls can be used. Especially adequate to develop a sense for ball and used. Net-game-set including 2 Mono-Fling nets and 2 balls, 7,5cm diameter, weight 340g. Size of the net 30,5 x 25cm, overall size including coated handles 53 x 25cm. Single or group play, in- or outdoors.

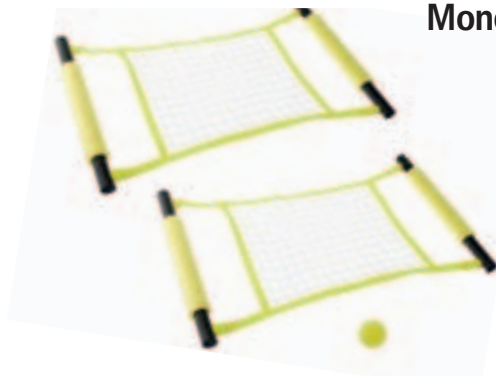

Mono-Fling



1072178

All Balls set of 6 (Set with 6 balls in 6 colors)

Multi-purpose inflatable balls with a high tactile surface. Can be used for juggling, paddle activities, Fling-it, hand squeeze activities and much more. Size, bounce and resistance can be adjusted through a standard athletic valve. 7,6cm diameter, 40g, available in a set of 6 balls.

1072181

BoundaLoons set of 6

The BoundaLoon furthers inclusion with its twin-hand hold design, allowing greater, two-handed control of the striking surface – a more basic and foundational striking skill upon which your students can build. Additionally, use the BoundaLoon in Two person, cooperative teams. Your imagination is the only limitation. To play with different balls. We recommend the AllBalls Set, art.-no.1072178. Each BoundaLoon is 43,2 cm in diameter, set of 6 colours.



BoundaLoons

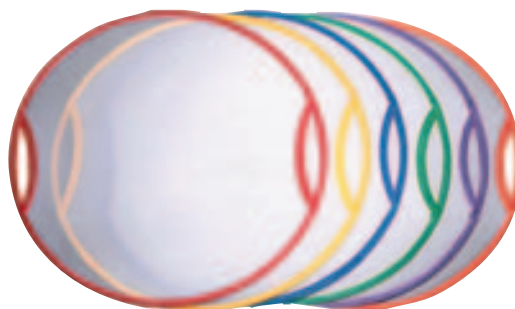

1072064

CatchBall

It is a funny way to simultaneously teach eye-tracking, eye-hand-coordination and memory. All this is accomplished in complete safety as guaranteed by our soft vinyl, air inflatable, roto molded construction. The ball has a 7,6cm diameter centre core from which six

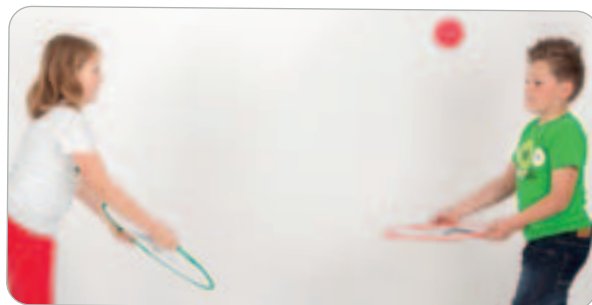

1072212

Springy Rackets, set of 2

Lightweight and handheld Springy Rackets act like mini trampolines to bounce a foam ball between 2 players. This active game can be cooperative or competitive and is ideal for improving hand-eye coordination. Handles are made of rubber foam for extra grip and users from all abilities. Set includes 6 rackets, 30 cm diameter and 6 foamballs, 6 diameter.

1072121

Super Foam Swing and Hoop

The objective of the game is to swing the ball forward and upward, then catch it in the hoop. Size of the game: 38cm. Diameter of the ring: 115mm. Diameter of the ball: 70mm. Sold in sets of 3, each with a primary color ball and its complementary color hoop.



Super Foam Swing and Hoop



CatchBall™



Springy Rackets

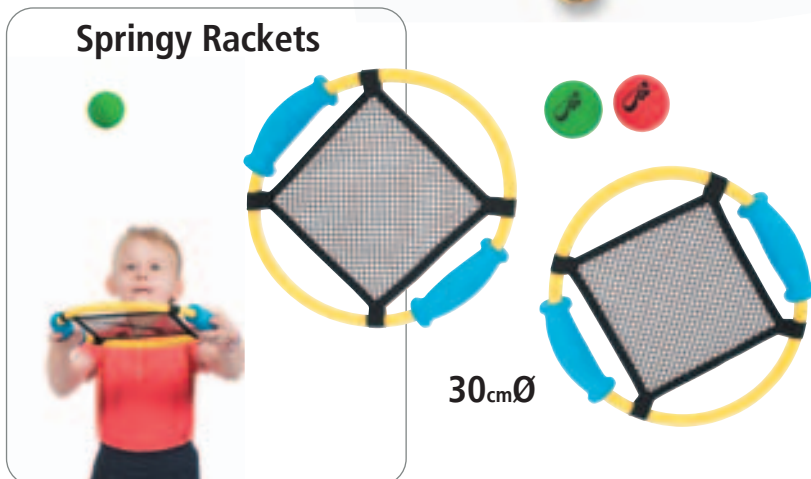

30cmØ



Buba Bloon

BubaBloon



Goal Ball Trainer



Grab-N-Balls Set of 3

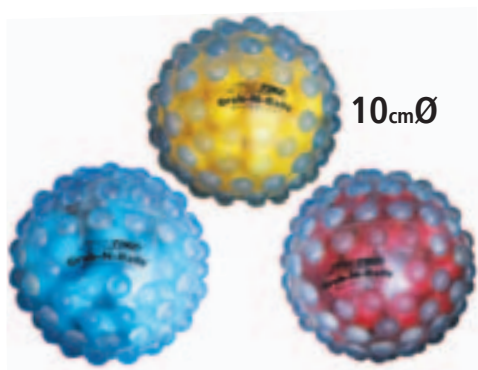

Egg-clock Balls set of 3



Blindfolds Set of 6



1000911

BubaBloon® Set of 3 Colour 3 textile balloon sleeves with 3 Premium each inflatable latex balloons

BubaBloon® is a child-friendly, textile balloon cover made of high-quality poplin cotton, which helps to transform normal balloons into safe, durable and reusable toys. In conjunction with the biodegradable BubaBloon premium latex balloons BubaBloon sleeves ensure that considerably higher loads can be withstood. The risk of unwanted bursting is therefore clear reduced, in addition, the textile cover offers an pleasant sense of touch and the beautiful patterns have a visually stimulating effect.

In the „inflated“ state the BubaBloon has a diameter of approx. 30 cm. BubaBloon balloon sleeves are absolutely easy to care and can be washed at 30°C in the washing machine.

1072236

Goal Ball Trainer

The very safe GoalBall makes it the perfect choice for training at all grade levels. Its integral-skin PU shell provides both structure required for full-court rolling and shock absorption on capture or impact. Most importantly: the jingling of the 3 sleigh bells inside can be clearly heard through its openings throughout the ball's entire roll cycle. Ø 23 cm.

1072176

Grab-N-Balls Set of 3

The outward gippy texture of the Grab-N-Ball is the same as the Roll-N-Rattle's one, while the chamber is filled with small PVC balls that silently glide off each other in a non-toxic gel. Available in sets of 3 colors (blue, red, yellow). Diameter: 10 cm, Gew. 170g.

1072183

Egg-clock Balls set of 3

Set of 3 egg-clocks each filled with different colored balls (one blue, one green and one purple) and different amounts of fill (90%, 60%, 30%) as well as a one highly visible yellow ball to track from side to side. The reward is the popping noise made as the yellow balls passes from one chamber to the other. Each loop has a loop for attaching on your own key chain. Size: 15 x 6,5 cm.

1072143

Colored Blindfolds

Thanks to their solid fabric and embedded corners around the edges these new Blindfold Goggles are 100% light-proof.

1072101

Elephant & Gator (Jiggler™) set of 2

Two small battery-operated devices in an appealing, childlike design for mouth- and face-massage. For relaxation and controlled vibration of face- and oral-musculature. The dynamic duo convinces with its design and functionality. The elephant's ears can be used as a spoon for orally defensive children. Available without batteries. Washable and sterilizable.



Elefant & Gator

1010157

Calm before the Little Storm

Movement & Memory cardgame for children from 4 years up, adolescents, adults, seniors, for 2 to 6 players. Calm before the Little Storm is a cardgame to train concentration, motor skills and physical awareness. As with a memory game players have to remember the place of the viewed cards and in addition to this the movement shown on the card. If one player draws a card with Little Storm on it, the play tries to remember themovement shown on a selected card. He has to make this movement and finds out when uncovering the card if he will win it (if the movement was correct). 35 Calm before Little Storm cards, thereof 28 movement cards and 7 Storm cards, card-size: 83 x 57 mm, playing time: ca. 10 - 25 minutes, card rules in 7 languages, carton packed



Calm before the Little Storm

1072242

Sensory Finger Set

The colorful gel-filled shapes are fun to squish — employing focus, attention, fine motor coordination and spatial relationship practice. They can be used to develop hand-eye coordination, dexterity and finger strength. The Finger Set is ideal for finger exercises and small hands but also to take anywhere with you. Set includes one small rectangle shape (10x4cm) and one small oval shape (10x5cm).



Sensory Finger Set

1072243

Sensory Circle Set

The colorful gel-filled shapes are fun to squish — employing focus, attention, fine motor coordination and spatial relationship practice. They can be used to develop hand-eye coordination, dexterity and finger strength. The Circle Set can be manipulated with your fingers, hands and even feet! Set includes one 9cm and one 19cm circle.



Sensory Circle Set

Sensory Floor Tiles Set of 4

A wonderful visual and tactile experience, that really does encourage you to move around and explore the surfaces. They are very thin floor tiles with flowing colours that swirl around as you move about on them. The tiles are filled with cosmetic liquid (non toxic), completely sealed and have a non slip bottom. The thick protective layer is highly scratch and abrasion resistant. They will withstand any amount of jumping on and strenuous use by children and adults as well as the weight of wheelchairs and trolleys. They can also be used on a table top or any flat surface. It only needs a little pressure to create a dramatic visual effect. Each tile measures 30 x 30 cm. Material: PVC, PE, water with colored cosmetic liquid.

1072222 Sensory Floor Tiles Set of 4 30*30cm

1072245 Sensory Floor Tiles Set of 4 50*50cm



30 cmØ



50cmØ

Sensory Floor Tiles Set of 4

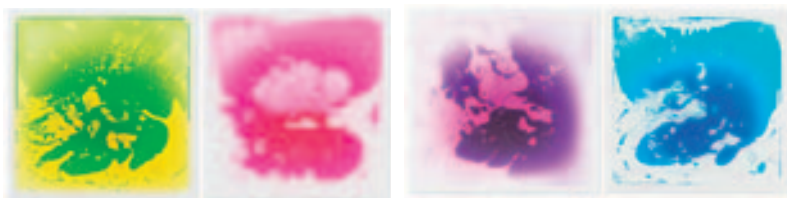

Motorik • Sensorik • Stimulanz • Spordas



**Water Column
with
Wooden Base**

Water Column

To watch the rising air-bubbles in the water column is always fascinating. We recommend the water column with wooden base, because it is stable and safe. The solid base of beech-wood is lined inside with sound-deadening Tretford carpet and provides felt gliders at the bottom.

- **Learning values:** visual and sensory perception, concentration, motivation, relaxation
- **Range of use:** play and education, therapy, field of sensory perception, meditation, waiting zones, senior-care

1300520

Water Column with Wooden Base

Water Column 130 cm high, 10 cm Ø plus set of swimming fishes, wooden base 39 x 39 cm, 19,5 cm high. Power connection 230V, LED-colour changer, on-off switch, (delivery in 2 colli).

1300521

Water Column

Water Column 130 cm high, 10 cm Ø, plus set of swimming fishes. Power connection 230V, LED-colour changer, on-off switch. Titanium coloured socket in conical form, ground area 21,5cm x 21,5cm.

1300506

Wooden Base for Water Column

Base made of beech-wood, screwed together, 39cm x 39 cm, 19,5 cm high. weight 6,5 kg.

Night Light "Stars"

The small night light table lamps for indoor use generate fascinating starlights in the dark. This can be helpful for orientation, calming and/or stimulance. LED-light, touch function, 8 cm high, 13,6 cm diameter. Battery-powered (3 x AA1.5V), not included in delivery.

1300526

Night Light "Stars" WHITE

White night light table lamp, battery-powered (3 x AA1.5V), not included in delivery.

1300527

Night Light "Stars" BLUE

Blue night light table lamp, battery-powered (3 x AA1.5V), not included in delivery.

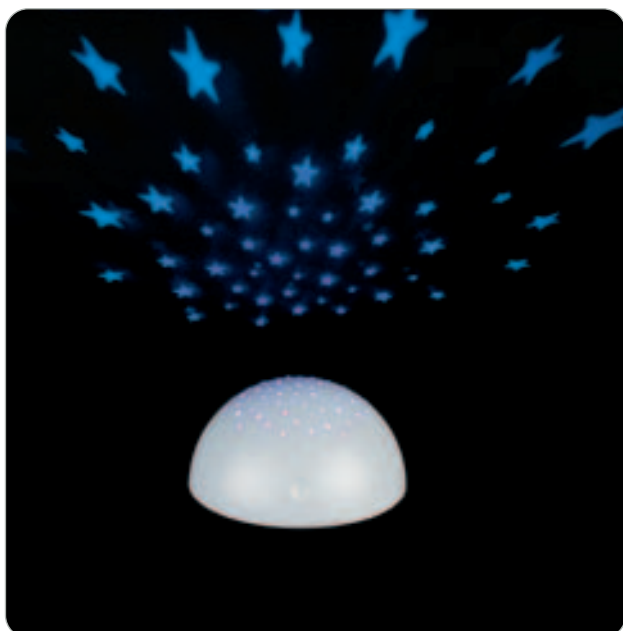

**Night Lights "Stars"
white or blue**

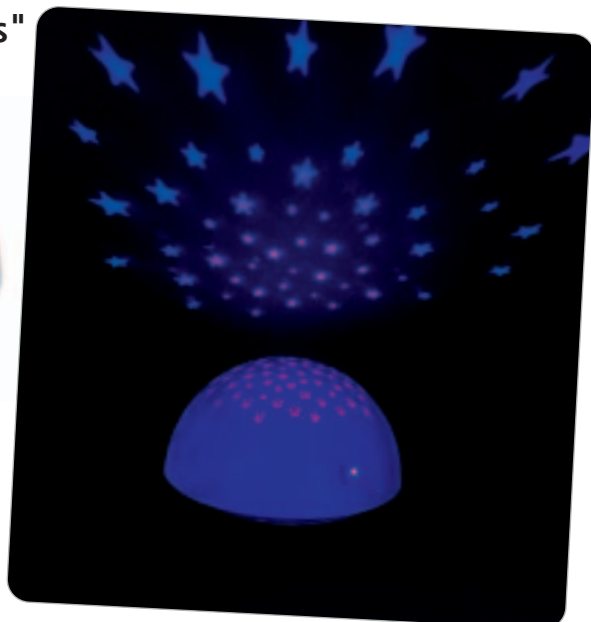
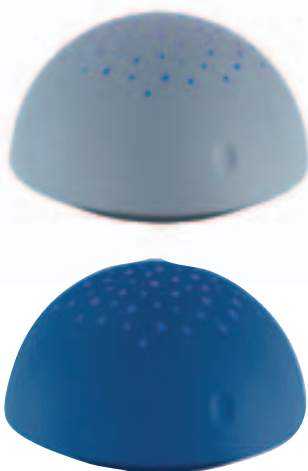

Fidget Blanket

The special design of the Fidget Blankets is particularly aimed at people with dementia. Due to their seize, realization and quality these blankets are also highly suitable for children from the age of three years.

Dementia patients are frequently motorically or physically active (specially with their hands) and in search of contact and external stimuli. Normally the sense of touch of patients with dementia is well pronounced. To touch and feel familiar and well known things provides security and gives a calming effect to affected persons. Fidget Blankets are made of four fabric squares with different patterns and woven structure, which are topically oriented to women and men. The material provides tactile and visual stimulations and might arouse well known memories: terrycloth for example is known from towels and bedclothes. Velcro stripes on the upper side of the blankets offer the possibility of individual mounting of personal and popular items. Velcro stripes can be closed into loops – then the desired item can be inserted – or the Velcro stripes will fix firmly any object. Both blankets additionally contain a zipper and a broad woven tape to tie a bow or a knot.

Laying on her/his lap, the blanket keeps cosy and warm. Placed on a table the size of the blanket allows two or three persons to use one blanket. The Fumbling Blankets in two attractive and high-quality workmanship are lined soft and comfortable. Handmade of certified organic cotton and harmless cutdly fur fabric in Germany, washable at 40°C gentle cycle. Approximately 70 cm x 70 cm x 1 cm.

1010357

Fidget Blanket "Lotta"

Approximately 70 cm x 70 cm x 1 cm.

1010358

Fidget Blanket "Anton"

Approximately 70 cm x 70 cm x 1 cm.

1072026

Fidget Finger Loop Set of 2

Like a sensory merry-go-round for your fingers, the „Fidgety Finger Loops“ will keep children engaged for hours. In the brightly colored loop, kids can work on tactile discrimination, sequencing, and color recognition while pushing a hidden ball through a maze of different colored and textured compartments. The blue canvas loop offers similar fidgety fun but in a solid color to reduce visual stimulation, and with a mesh transition panel to add assistance with visual tracking of the target ball. Dimensions: 75 cm, width: 9 cm, machine washing 30°C.



Fidget Blanket "Lotta"



Fidget Blanket "Anton"

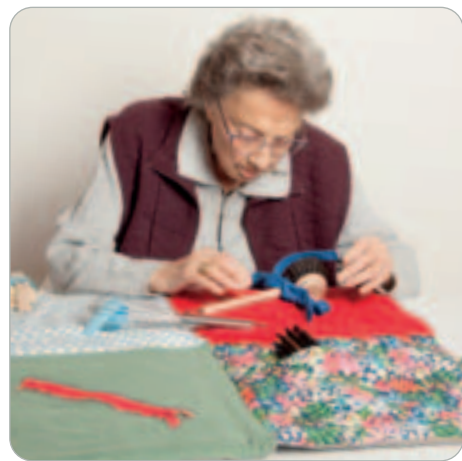

Fidget Finger Loop Set





Baby Nils

Rubens Baby

3+



14 cm

Ø 5 cm

Babybottle and Dummy

Rubens Baby (this and next page)

These nice Rubens Babies fit perfectly in the concept of Rubens Barn dolls. Their bodies have been formed as realistically as possible with round babies' bottoms and cute baby faces. Of course all babies can suck their thumb! Six babies, about 3 months old, always a boy and a girl in three different skincolours. Each baby wears a t-shirt and diapers, a patterned romper suit and a little bib with a nice animal head. Length 45 cm, weight 700 g, suitable for all ages.

Made of polyester fleece filled with polyester fibre and granules, hair of soft polyester. All babies are machine washable in a soft cycle of 30°, the outfits are to be hand washed.

- | | |
|--------------------------|---------------------------|
| 1010424 Rubens Baby Nils | 1010423 Rubens Baby Molly |
| 1010422 Rubens Baby Max | 1010421 Rubens Baby Emma |
| 1010420 Rubens Baby Erik | 1010425 Rubens Baby Nora |

Baby bottle and baby dummy

Ideal accessory for all Rubens Babies: light blue or pink baby bottle with baby dummy. Rubens Babies can put both in the mouth.

- | |
|---|
| 1010428 Baby bottle and baby dummy light blue |
| 1010429 Baby bottle and baby dummy pink |

Baby Accessories

All parents of Rubens Baby dolls will love these nice and practical accessories kits for Rubens Baby. A cuddly blanket for covering and a changing nappy, a drinking cup with handles and a baby bib. All items are carefully stitched and manufactured and washable at 30 degrees, clothing is recommended to be hand-washed. From 3 years (all items without dolls).

- | |
|--|
| 1010504 Changing Kit (Blanket, nappy, towel) |
| 1010505 Feeding Kit (Drinking cup, spoon, bib) |

1010427

Diaper Set

The Diaper set for the Rubens Baby doll is a fun way of learning to change diapers. The set consists of 2 x nappies, pee from soft plush with velcro tape for fastening onto the diaper, poo from soft plush with velcro tape for fastening onto the diaper. From 3 years.



Baby Max



Baby Erik



Changing Kit



3+

Diaper Set

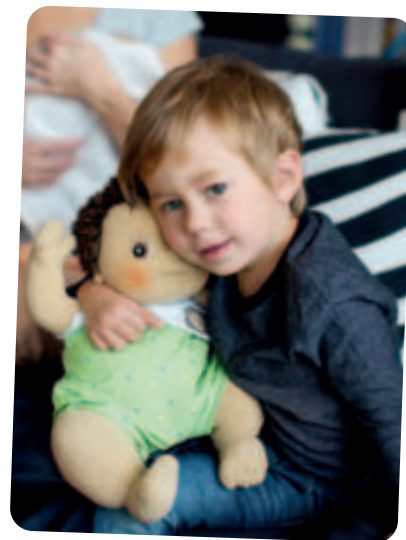

3+

Feeding Kit





Baby Nora



Baby Emma

45 cm

four piece outfit



Baby Molly



Baby Accessories (this page and page before)

Cute pyjamas for the night, suit and dress for special occasions and a neat carrycot with functional details and different applications, which does not only enjoy Baby Erik. All items are carefully stitched and manufactured and washable at 30 degrees, clothing is recommended to be hand-washed. From 3 years (all items without dolls).

Pajamas

The pyjamas have a little pocket friend who shows different emotions depending on how a Rubens baby feels after a game day.

1010500 Green Pajamas

1010501 Pink Pajamas

1010506 Carrycot

Carrycot - without contents - for a bottle, dummy and other small things. 4 functions in one bag: carrying bag, baby carrier for the back, baby carrier for the front and a baby bed.

1010502 Handsome (suit)

1010503 Pretty (dress)

new design



3+

Pink Pyjamas

Green Pyjamas



Carrycot

3+



3+



Pretty



3+

Handsome

Rubens Kids

Rubens Kids

This collection of dolls by Rubens Barn shows seven individual dolls, who instantly capture the heart of small and big doll mummies and doll daddies by their personal presence. Bobbo, Mimmi, Lollo and Cicci wear a light summer-outfit. Each Rubens Kids outfit is available separately.

Height: 36cm, Weight: 350g. (Without any age limit. Recommended for all children) Material: Made of polyester fleece filled with polyester fibre, bottom filled with granules. All dolls are machine washable in a soft cycle of 30°C, the outfits are to be hand washed.

1010409 Rubens Kids Oliver

1010411 Rubens Kids Cicci

1010412 Rubens Kids Mimmi

1010413 Rubens Kids Lollo

1010415 Rubens Kids Olivia

1010416 Rubens Kids Tim

1010417 Rubens Kids Clara



Oliver

36 cm



Olivia



Clara



Lollo



Tim



Mimmi



Cicci

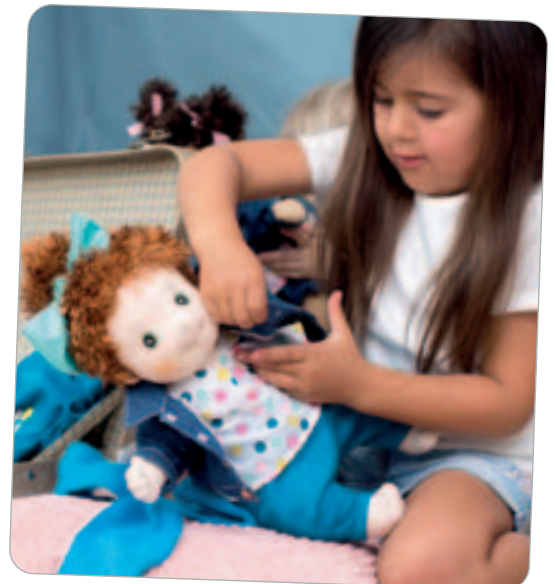

Rubens EcoBuds

Say hello to EcoBuds, Rubens Barn's first doll in soft organic cotton! EcoBuds are certified with the Organic Content Standard (OCS), who allow for independent verification of organic material by an accredited third-party certification body. Just like all dolls from Rubens Barn, EcoBuds are handmade and of the highest quality. All with happy unique characters for us that kids at heart. Striped or dotted top and leggings, removable skirt, machine-washable at 30 °C (low tumble-dry heat) . In deco-box, height 35 cm, weight 150 g, without age restriction.

1010507 Rubens Eco Bud Daisy

1010508 Rubens Eco Bud Hazel

Rubens Mini EcoBuds

Mini EcoBuds are the smallest handmade and sustainably produced Rubens Barn dolls. Friendly and with a lot of character, the Mini EcoBuds follow the little ones and offer comfort while sleeping and playing. Each doll has two straps on the back for attachment to bag, stroller or bed. Striped or dotted top and leggings, skirts or shorts to undress. Machine-washable at 30 °C (low tumble-dry heat) In deco-box, height 23 cm, weight 53 g, without age restriction.

1010450 Rubens Mini EcoBuds Elm

1010451 Rubens Mini EcoBuds Flora

1010452 Rubens Mini EcoBuds Basil

1010453 Rubens Mini EcoBuds Lily



Daisy



Hazel



35 cm

Rubens EcoBuds



Rubens Mini EcoBuds



Elm



Flora



Basil



Lily

23 cm



Rubens Cutie Activity



Charlie Activity



Hannah Activity

32 cm

Rubens Cutie Activity

Be it food, painting or playing outside, these cuties like to show up dressed for the occasion. Weight: 155 g, height: 32 cm, from 0 years.

1010513 Rubens Cutie Hannah Activity

1010514 Rubens Cutie Charlie Activity

Rubens Cutie

Products from Rubens Barn combine unique design, high quality and handmade production. It takes more than 100 different steps to make one Rubens Barn doll. Every part in this handmade process is carefully quality controlled. The cuties are perfect for children to cuddle and play with. Weight: 155 g, height: 32 cm, from 0 years.

Two extra outfits are available for Rubens Cutie.

1010526 Rubens Cutie Emelie

1010527 Rubens Cutie Karin

1010528 Rubens Cutie Jennifer

1010529 Rubens Cutie Charlie

1010431 Rainy Day für Cutie

The perfect outfit for fun and play in the rain. The set consists of: A classic yellow rain jacket, a pair of black rain boots. From 3 years. (without doll)

1010430 Back to School für Cutie

The perfect choice for the start of the new school year! The set consists of: One multicoloured striped sweater, one pair matching jeans, a green backpack with velcro in the opening of the bag. From 3 years. (without doll)

Rubens Cutie



Emelie



Jennifer



Charlie



Karin



Rainy Day

3+



Back to School



Rubens Barn Original (Born in Sweden)

This is the wonderful collection of fabulous Rubens Barn dolls. Each doll is designed to share and experience emotions, situations, atmosphere like fantasy, suggestion, inspiration, feeling of security, closeness, joy, sorrow and so on. The innovative design concept with carefully sculptured soft faces and delicately embroidered eyes reflects the loving, realistic and charismatic expression. Each character has its own precious look and personality to complement its owner. But for all that each Rubens Barn doll gives its owner plenty of leeways to be filled with specific emotions, contents, requirements and situations. Made by detailed, specific manual work at 100%. Material: 100% polyester fleece stuffed with polyester fibre, the bottom is firmly stuffed with granulate which allows the dolls to sit comfortably. All dolls are machine washable in a soft cycle of 30°, the outfits are to be hand washed. From 3 years.

Rubens Barn Original

3+

- Each doll has its own charismatic expression and is 100% hand-made. Made from polyester-fleece, machine washable in a soft cycle of 30°, outfits are to be hand washed. Length 50cm, weight 1000g.
- Anna «Kindy» and Emil «Teddy» are wearing very special affectionately arranged clothes.

1010516 Rubens Barn Original Anna «Kindy»

1010518 Rubens Barn Original Emil «Teddy»

1010519 Rubens Barn Original Meiya

1010520 Rubens Barn Original Harry

1010521 Rubens Barn Original Maria

1010522 Rubens Barn Original «Anna Jeans»

1010523 Rubens Barn Original «Emil Club»

1010524 Rubens Barn Original «Ida Pink»



Emil «Teddy»



Anna «Kindy»



Didaktik • Spielen & Lernen • Rubens Barn



Meiya



Maria



«Emil Club»



Harry



«Anna Jeans»



«Ida Pink»



Giant Puzzle

Fruits



Vegetables

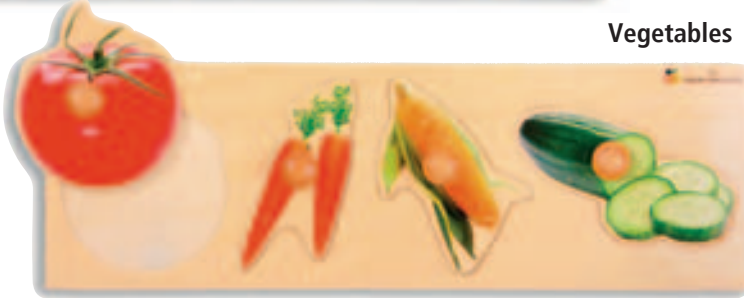

Wooden Knobs Puzzle



Tools

40 years experience in the development of learning materials for early childhood, high-grade and improved quality, high safety standards and beautiful and attractive design: We have been convinced by these basic features and offer a selection of the most popular DORON puzzles and learning games.

Giant Puzzle

First giant puzzles (size: 50 cm x 16 cm x 12 mm), specially designed for very young children and children with special needs. The extra thick and large pictures are silkscreen printed directly onto the wood, and have extra big wooden knobs (Ø 30 mm) for easy handling. Through the contents "fruit" and "vegetables" an early reference to healthy food can be created. Age 2+

1100235 Giant Puzzle Vegetables

1100236 Giant Puzzle Fruits

Wooden Knobs Puzzle

A range of high quality wooden puzzles (24 x 30 x 0,9 cm) with single large pieces. Pictures are silkscreen printed directly on the plywood and have big wooden knobs for easy handling. Age 2+

1100233 Wooden Knobs Puzzle Tools

1100234 Wooden Knobs Puzzle Garden Tools

1100203 Wooden Knobs Puzzle Vegetables

1100204 Wooden Knobs Puzzle Fruits

1100105 Wooden Knobs Puzzle Butterfly

1100106 Wooden Knobs Puzzle Snail



Butterfly



Snail

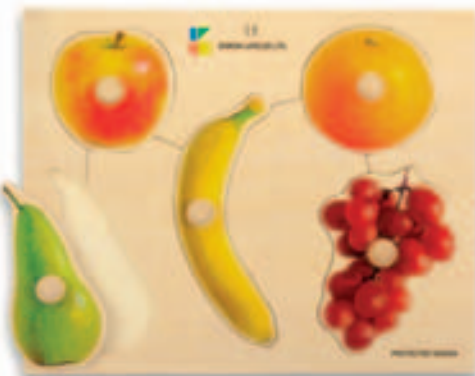

Fruits



Vegetables



Garden Tools

Wooden Puzzle Realistic

A range of high quality wooden puzzles (24 x 30 x 0,7 cm) with single large pieces. Pictures are silkscreen printed directly on the plywood and have big wooden knobs for easy handling. Age 2+

1100246 Wooden Puzzle Realistic Set of 5 animals

1100247 Wooden Puzzle Realistic Duck

1100249 Wooden Puzzle Realistic Parrot

1100248 Wooden Puzzle Realistic Hedgehog

1100252 Wooden Puzzle Realistic Dog

1100251 Wooden Puzzle Realistic Cat

1100245 Wooden Puzzle Realistic Rooster

1100244 Wooden Puzzle Realistic Rabbit

1100242 Wooden Puzzle Realistic Fish

1100243 Wooden Puzzle Realistic Butterfly



Set of 5 animals



Dog



Duck

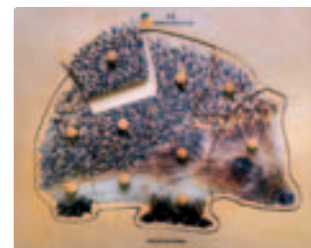

Hedgehog



Cat



Parrot

Wooden Puzzle Realistic



Rooster



Rabbit

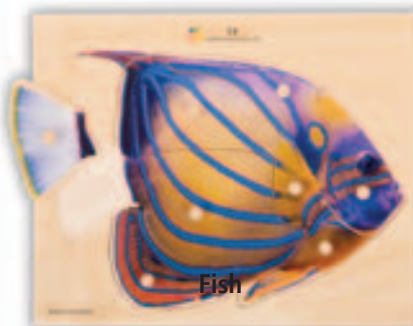

Fish



Butterfly

Try-Angle



1100239

Try-angle

While playing with this magnificent pattern game, children explore and discover the features of triangles and their various combinations like rhombus, trapezium and hexagons. They can copy the included designs and create many more interesting patterns by their own. 6 triangular wooden frames (30 x 30 x 30 cm), 108 colored triangles (10 x 10 x 10 cm) made of wood, 12 training cards (20 x 20 cm), stored in a wooden solid box. Age 3+



Kaleidoscope

1100214

Kaleidoscope

The kaleidoscope game designed to stimulate geometric exploration and visual discrimination by reconstructing the symmetry mosaics. It also promotes creativity and imagery thinking as children can make a lot of beautiful designs by their own. Six children can play at the same time. Age: 4+. 6 squared frames (14 x 4 cm), 54 tiles (4 x 4 cm) and 30 pattern cards. All components are made of high quality plywood with silk-screened printed designs, stored on a solid wooden box (34 x 18 x 8 cm). Age 4+

1100237

Butterfly Domino

This unique and challenging domino game supports the learning of symmetry and directions by the real-life photos of butterflies. Content: 28 wooden cards (10 x 5 x 0,8 cm) stored in a solid wooden box. Age 3+



1100238

Complete Ten

The Complete Ten is a challenging domino game designed to promote mathematic skills, by learning the various combinations that make ten, as an essential basis of addition and subtraction. 36 extra large and thick wooden domino tiles (10 x 5 x 0,9 cm), stored in a solid wood box (33 x 14 x 8 cm). Age 5+.

1100139

Color Slit Game

A unique sorting and matching device for colors, shades, quantities and numbers learning. It designed to promote basic mathematic skills and independent learning. All the components are made of the highest quality plywood with silkscreen printing illustrations. 1 wooden sorting box (46 x 16 x 7 cm) divided into 10 compartments, covered by a hinged lid with 10 slots, 4 double-sided wooden strips (44 x 4 cm) and 70 corresponding cards (5 x 4 cm) that stored in 2 wooden boxes. Age 3+

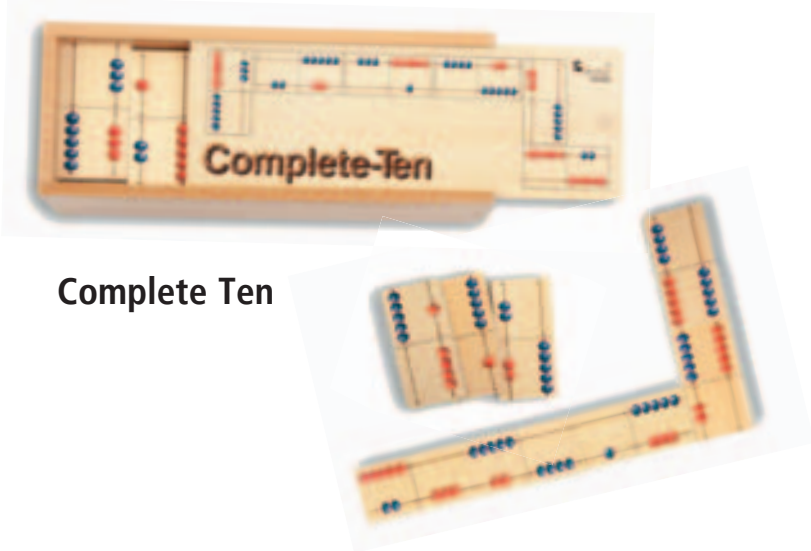

Complete Ten



Color Slit Game



1100253

Wooden Puzzle Size & Depth Set of 3 (Frogs, Rabbits, Cats)

Pretty, friendly animal puzzles for small children that encourage self-learning of size relations and spatial perception of space and depth. This improves early mathematical skills such as measuring and comparing as well as fine motor skills and eye-hand coordination. 24,2 cm x 15 cm.



Puzzles Set of 3 Size & Depth

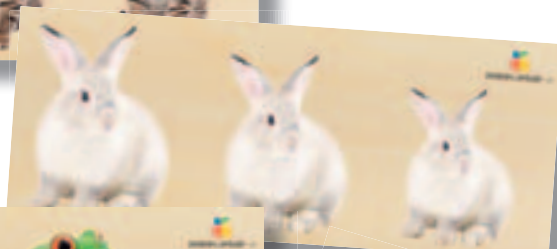

1100241

Wings of Color

Visually stimulating, colorful magnetic game with a high Calling character. Each player tries to complete as many butterflies as possible on his or her petal (max 4). A complete butterfly should have 4 wings in 4 different colours or 4 wings in the same colour. The wings are connected by magnets to the body of the butterfly. Only complete butterflies count at the end of the game.

Learning key: Visual representation, color differentiation, planning and strategic thinking understanding of game play and instructions, social and fine motor skills.

Contents: 1 nectar base with 12 nectar pushpins, 4 petals, 16 magnetic butterfly bodies, 64 magnetic wings in 4 colors, 16 flower stalks, 2 wooden dices (colours and icons), incl. Game instructions in sturdy telescope box. For 2- 4 players, from 4 years.

Wings of color



3D Puzzle for building bricks

With these attractive wooden forms, building with existing small and large building bricks, such as DUPLO and LEGO bricks, becomes even more varied and diverse. In addition to role-playing, the 3D wooden puzzles stimulate and create new game worlds. The castle and the tree house contain other game elements, such as a catapult or ladder and swing. The precisely sawn wooden parts can be simply inserted into each other and when not in use they can be folded together to save space. The wooden parts are made of untreated, 3 mm thick birch plywood and can be painted individually. Assembly instructions included. Delivery without modules.

3301702 3D Puzzle for building bricks House

for big bricks, 17,8 x 14,6 x 9 cm, 4 pieces, Age 2+

3301501 3D Puzzle for building bricks castle

for small bricks, 25,5 x 13,5 x 19, 5 cm, 8 pieces, Age 3+

3301502 3D Puzzle for building bricks treehouse

for small bricks, 22 x 18,5 x 23,5 cm, 7 pieces, Age 3+

3301602 3D Puzzle for building bricks spaceship

for small bricks, 7 pieces, Age 3+

3D Puzzle for building bricks

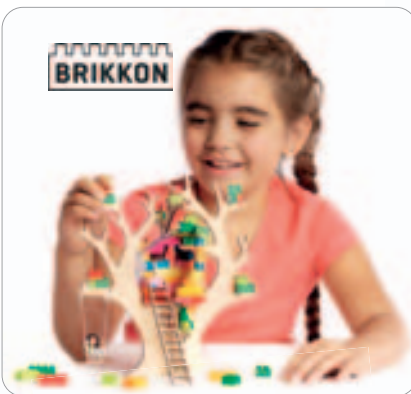

Treehouse

House

Castle

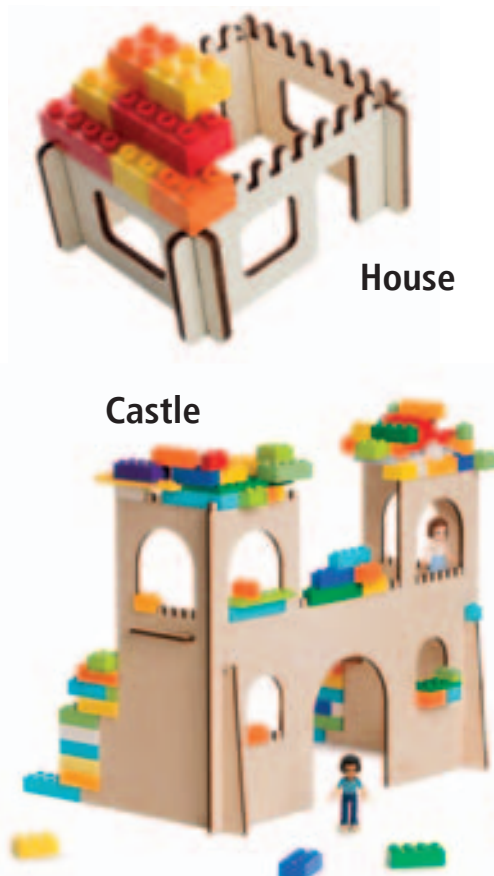

Spaceship

Building plates

Building plate small

Building plate large

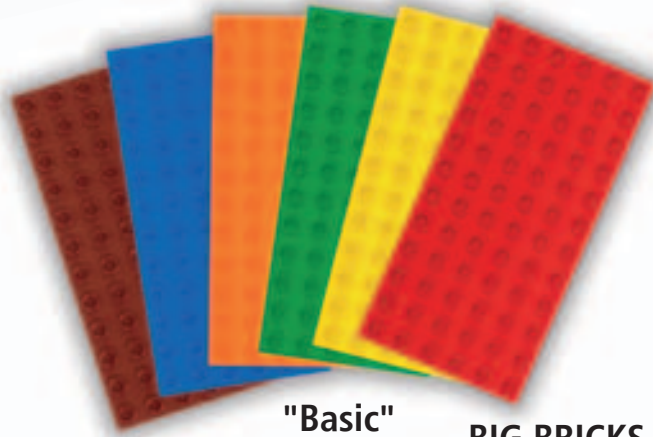
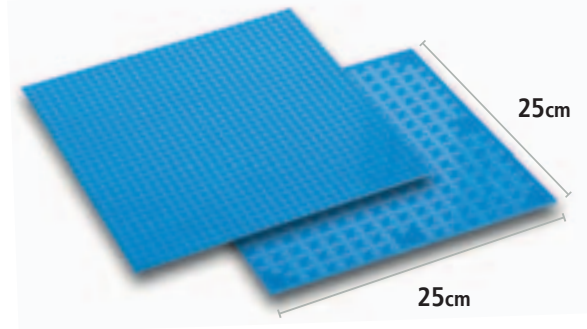
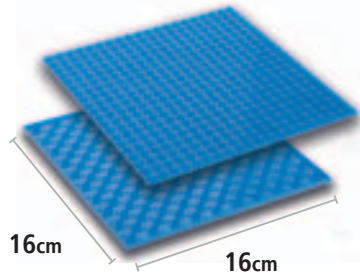
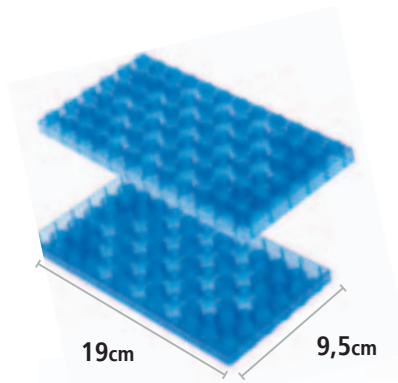

"Basic"

BIG BRICKS Plates

BIG BRICKS Plates

New building plates that convince! The square plates are available in new, modern and attractive sets, thematically sorted by colour. But you can do even more. The building plates can be covered with big building bricks, such as DUPLO® bricks, from both sides. Building up into the heights becomes possible without any problems and creates versatile and varied game variations. 19 cm x 9,5 cm.

3302201

BIG BRICKS Plate 6 x 12 knobs set of 4 Clear Colours

3302202

BIG BRICKS Plate 6 x 12 knobs set of 4 Standard

3302203

BIG BRICKS Plate 6 x 12 knobs set of 6 Pastell

3302204

BIG BRICKS Plate 6 x 12 knobs set of 6 Basic

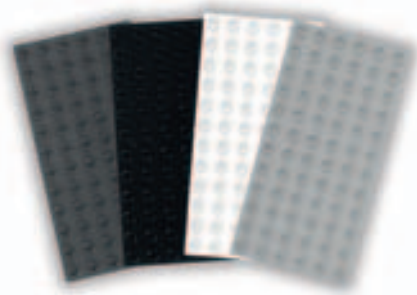

"Standard"



"Pastell"

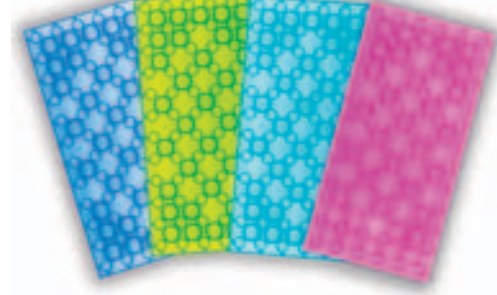

"Clear Colors"



"Pretty Pink"

Building plates

Building plates

Building plates available in 6 different colour sets, each set in two sizes:

Building plate small 16 cm x 16 cm (20 x 20 knobs)

Building plate large 25 cm x 25 cm (32 x 32 knobs)

3302006 Building plate small 20 x 20 knobs set of 6 "Pretty Pink"

3302106 Building plate large 32 x 32 knobs set of 6 "Pretty Pink"

3302003 Building plate small 20 x 20 knobs set of 4 "Modern Look"

3302103 Building plate large 32 x 32 knobs set of 4 "Modern Look"

3302001 Building plate small 20 x 20 knobs set of 4 "Grey Brothers"

3302101 Building plate large 32 x 32 knobs set of 4 "Grey Brothers"

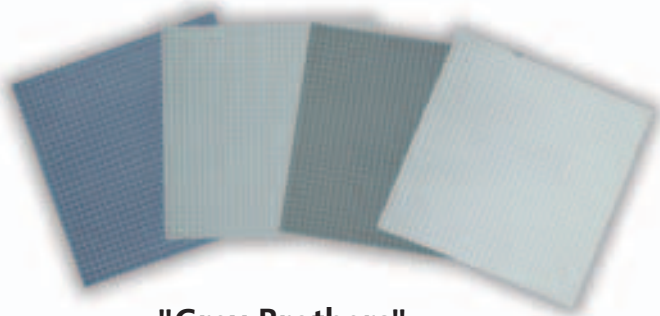

"Grey Brothers"



"Modern Look"

Building plates

The square plates are available in new, modern and attractive sets, thematically sorted by colour. But you can do even more! The building plates can be covered with small building bricks, such as Lego bricks, from both sides. Building up into the heights becomes possible without any problems and creates versatile and varied game variations. On the upper side, large modules such as Duplo bricks can also be installed.

Building plates available in 6 different colour sets, each set in two sizes:

Building plate small 16 cm x 16 cm (20 x 20 knobs)
 Building plate large 25 cm x 25 cm (32 x 32 knobs)

3302005
 Building plate small 20 x 20 knobs set of 6 "Basic"

3302105
 Building plate large 32 x 32 knobs set of 6 "Basic"

3302004
 Building plate small 20 x 20 knobs set of 6 "Transparent"

3302104
 Building plate large 32 x 32 knobs set of 6 "Transparent"

3302002
 Building plate small 20 x 20 knobs set of 4 "Nature Trend"

3302102
 Building plate large 32 x 32 knobs set of 4 "Nature Trend"



"Basic"

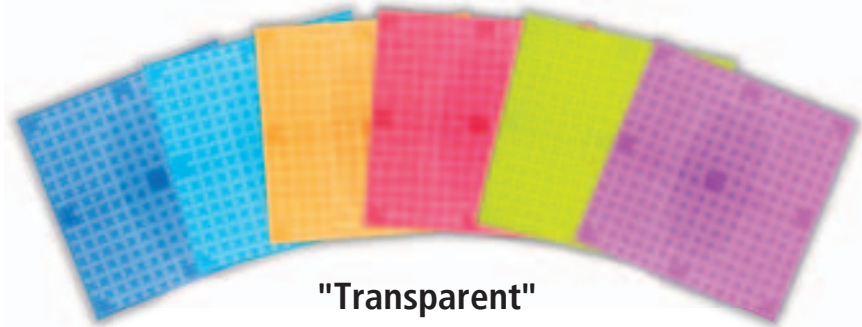

"Transparent"

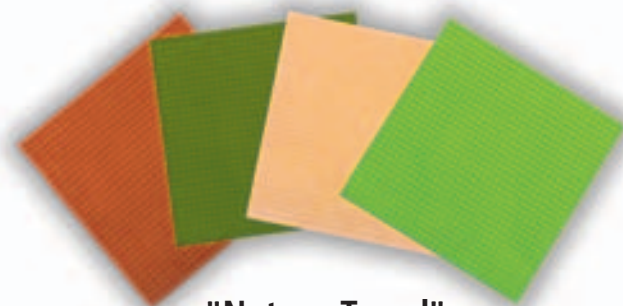

"Nature Trend"

Building plates

3300008
Apitor SuperBot

The Apitor SuperBot is a programmable and app-controllable do-it-yourself robotic system with over 400 parts and 18 pre-defined robot models for replication.

Learn simple programming!

With the graphical drag & drop coding interface (included in the free app for IOS and Android), kids playfully learn how to program their robot to follow lines, bypass obstacles, detect distances, control LED lights, and more.

Compatible with popular brand building blocks

The Apitor SuperBot is compatible with other branded devices that can be combined with the Apitor devices and the Apitor controller to form intelligent devices and a robotic system.

From 8 years.



Apitor SuperBot



VIDEO



over 400 Parts



incl. free App for IOS and Android



18 pre-defined robot models for replication

Light Stax® JUNIOR Kiga Set (compatible with LEGO® DUPLO®)



LIGHT STAX®

Light Stax bring enlightenment to the world of toy construction blocks! Light Stax are beautifully illuminated construction blocks that use LED technology. Building and playing becomes even more creative, exciting, varied ... and brighter: Each building unfolds its very special effect in darkness. There are infinite possibilities, fantastic figures and shapes to build to make it glow. Light Stax Standard is compatible with LEGO® building bricks and elements; Light Stax Junior is compatible with LEGO® DUPLO® building bricks and elements. The power source is always the USB Power Base, which uses a simple plug-and-socket connection to transmit the energy from stone to stone. The Light Stax Power Tables offer a large playground and construction area to create large, versatile constructions and to light them up.

Light Stax Kiga Sets

The Light Stax Starter Sets for kindergartens in the versions JUNIOR (compatible with LEGO® DUPLO®) and SYSTEM (compatible with LEGO®) offer many possibilities to build and light up figures and forms or to creatively complement existing buildings made of LEGO® DUPLO® or LEGO® bricks.

3310600

Light Stax JUNIOR Kiga Set

- 77 parts
- 15 stones 2 x 2, 5 stones 2 x 3 and 5 stones 2 x 4 each in the colours yellow, red, blue
- 1 x USB Smart Base
- 1 x USB cable 80 cm
- Delivery in Polybag
- Supplied without USB charger Adapter

3310800

Light Stax JUNIOR Maxi Set (compatible with LEGO® DUPLO®)

This extensive set is compatible with LEGO DUPLO building bricks and elements. The USB Power Base is the power source and is powered by the USB port. Optionally the USB Power Base can be used with 3 AAA batteries (not included in the scope of delivery) and thus light up the LED bricks in a mobile and flexible way. The set comes in a practical, very sturdy folding box, which offers enough space for the complete set and is easy to open and close. **Important: The individual LED bricks must always have a connection.**

Content:

- 180 LED bricks opaque (115 bricks 2x2 • 30 bricks 2x3 • 35 bricks 2x4)
- 2 x USB Power Base (6,4 x 6,4 cm), optionally battery-operated (3 AAA batteries not included in the scope of delivery)
- USB Power Base JUNIOR with 3 different light modes to choose from: Permanent lighting - flashing - dimming
- 2 x USB cable (3 m)
- Including manual
- Supplied in sturdy hinged box
- The Light Stax Junior Maxi Set is compatible with the Light Stax Power Table Junior.

Please note: The USB Power Base requires a USB charger adapter, which is not included in the scope of delivery.

3310905

Light Stax Power Table JUNIOR (compatible with LEGO® DUPLO®)

Start building at any point to light up the STAX. The Power Table is the ideal basis for group work or individual play in kindergarten, day nursery and schools. The Power Table has a permanently installed adapter cable (approx. 3m), which is connected to the Power Base in order to supply the LED bricks with energy and to be used as a power supply for the LED

Light Stax® JUNIOR Maxi-Set (compatible with LEGO® DUPLO®)



Delivery in hinged box

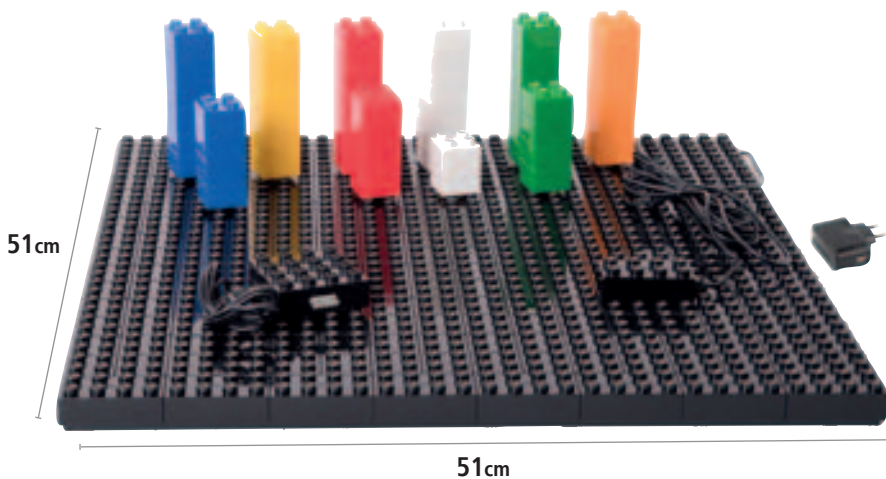

Light Stax® SYTEM Kiga Set (compatible with LEGO®)



3310700

Light Stax SYSTEM Kiga Set

- 182 parts
- each 20 stones 2 x 2 and each 30 stones 2 x 4 in the colours yellow, red, blue
- 15 stones 2 x 2 and 2 x 4 in green each
- 1 x 4x4 Mobile Power Stax with sound activator
- 1 x USB cable 80 cm
- Delivery in Polybag
- Supplied without USB charger Adapter

3311800

Light Stax SYSTEM Maxi Set (compatible with LEGO®)

This extensive set is compatible with LEGO building bricks and elements. The USB Power Base is the power source and is powered by the USB port. Additionally the USB Power Base is equipped with an internal rechargeable battery which can be charged thus light up the LED bricks in a mobile and flexible way. The set comes in a practical, very sturdy folding box, which offers enough space for the complete set and is easy to open and close. **Important: The individual LED bricks must always have a connection.**

Content:

- 360 LED bricks (273 x opaque • 87 x transparent)
- (130 bricks 2x2 • 230 bricks 2x4)
- 3 x USB Power Base (3 x 3 cm) with integrated rechargeable battery
- USB Power Base SYSTEM with 4 different light modes to choose from: Permanent lighting - flashing - dimming - reaction to acoustic signals (latching, snapping, screaming etc.)
- 3 x USB cable (3 m)
- 3 x Stax Separator (brick or part separator)
- Including manual
- Supplied in sturdy hinged box
- The Light Stax Standard Maxi Set is compatible with the Light Stax Power Table Standard.

Please note: The USB Power Base requires a USB charger adapter, which is not included in the scope of delivery.

3319050

Light Stax Power Table SYSTEM (compatible with LEGO®)

Start building at any point to light up the STAX. The Power Table is the ideal basis for group work or individual play in kindergarten, day nursery and schools. The Power Table Standard is compatible with LEGO building bricks and elements. The supplied Power Base must always be connected to the Power Table and can be either connected with the USB charging cable or with the charged, internal rechargeable battery and thus can be used in a mobile and flexible way.

Content:

- 1 Power Table (knobs: 64x64), measurements 54cm x 54cm



Light Stax® SYSTEM Maxi Set (compatible with LEGO®)

Number of pieces:
273 x opaque
87 x transparent



Delivery in hinged box

Light Stax® Power Table SYSTEM (compatible with LEGO®)

Number of pieces:
50 x transparent

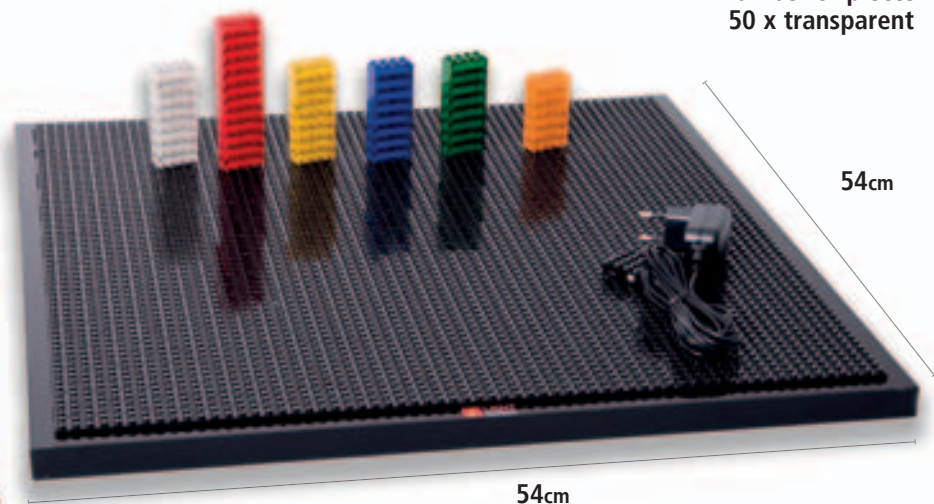

Playtable for LEGO® und DUPLO®



Playtable for LEGO and DUPLO, optionally with 4 stools or 4 foam-cubes

Stable, square table made from lacquered beech comes with a fixed LEGO plate at center for building with LEGO or DUPLO elements. LEGO or DUPLO elements can be stored at circular deepening and are always ready to hand. Corner joints are very stable, high-quality handcrafted accomplishment (made in Germany) guarantees functionality and durability with high play value appropriate for children. For children from 1 ½ years. Optionally with 4 small, round stools, each one with one-coloured surface (blue, red, yellow and green) or with 4 foam-cubes in blue, red, yellow or green colour. Provided with 144 LEGO DUPLO elements Playtable is ready to play.

3051000

Playtable for LEGO and DUPLO

This stable table can be equipped with available chairs or stools. Dimensions 76 x 76 cm, LEGO plate: 38 x 38 cm, deepening: 9 cm width, 5 cm height, height play table: 51 cm, incl. 144 LEGO DUPLO elements.

3051001

Playtable for LEGO and DUPLO with 4 coloured stools

Small, round stools with varnished and one-coloured seating surface (blue, red, yellow and green) and 4 stool legs easy to be repositioned by children. Dimensions: H.: 30 cm, W.: 30 cm (seating surface: 25.5 cm), incl. 144 LEGO DUPLO elements.

3051002

Playtable for LEGO and DUPLO with 4 coloured foam-cubes

Small, square foam-cubes perfect for small children, cubes are stable, easy to move and injury-free in handling. Each cube has a durable bottom made from gymnastic-mat fabric, sides are made from coloured tarp fabric in blue, red, yellow or green colour. Durable cover material is free of phthalates, foam density 65. Dimensions 30 cm x 30 cm x 30 cm, incl. 144 LEGO DUPLO elements

3051003

Foam Cubes 30 x 30 cm, set of 4

Each cubes has a durable bottom made from gymnastic-mat fabric, sides are made from coloured tarp fabric in blue, red, yellow or green colour. Durable cover material is free of phthalates, foam density 65. Dimensions 30 cm x 30 cm x 30 cm.

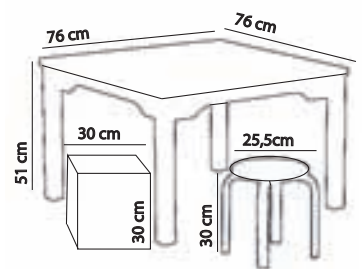

with 4 Stools



with 4 Foam-Cubes



BIOBUDDI Special Set

The environmentally friendly and sustainable alternative: These building blocks in beautiful, bright colours and with a very pleasant feel are made from the remains of the sugar cane plant and other bio-based materials. Made in the Netherlands.

The set supports children's creativity and imagination and promotes fine motor skills and imagination. All components are compatible with existing brand elements, for example DUPLO elements. The set is supplied in a practical, sturdy folding box that is easy to open and close and in which the bricks can be stored neatly.

Optionally and as a sustainable alternative also in a Cotton bag available.

3302901

BIOBUDDI Special Set / Folding box

240 elements + 4 plates L 25,5 cm, B 12,8 cm in a practical folding box, L 40 cm, W 30 cm, H 23 cm.

3302900

BIOBUDDI Special Set / Cotton bag

240 elements 4 plates L 25,5 cm, B 12,8 cm in a cotton bag, W 40 cm, H 49 cm.

3300001

Special Set with LEGO DUPLO elements

This Special Set with LEGO DUPLO elements inspires children's creativity and imagination. Implementing, planning, building, dismantling and reassembling ideas - this promotes fine motor skills and the ability to express oneself. The 240 elements convince with modern, appealing colours and decorative elements. The set is delivered in a practical, very sturdy hinged box which offers enough space for the complete set and is easy to open and close. 240 elements, age group 3-5 years.

3009000

LEGO Education Special Set

A large group of more than 20 children can build creative, imaginative and realistic LEGO models, constructions and landscapes with this special set and adults will enjoy the price advantage! Article 3005020,3005022,3009385 and 3009386 in one set. 2741 elements, from 4 years.

BIOBUDDI

NEU

Jakobs

BIO



+

**BIOBUDDI®
Special Set**



Special Set with LEGO® DUPLO® elements



LEGO® Education Special Set





Magnetic Fishing Set

9 18m+



• By encouraging children to communicate their ideas through imaginative play the TOLO® Education range supports young children's personal, social and emotional development. It also supports the creative and playful learning and lots of imaginative role play. All products are designed to stimulate children's learning and development through fun and imaginative ways. TOLO® Education create products that are safe, durable and easy to clean for longevity of play and the ideal equipment for crèches and toddler groups. (Piece count in circle icon)

3010017 TOLO Magnetic Fishing Set

This bright, colourful set enables early group play as children learn about the concepts of water and magnetism through a fun fishing game. Features six fish and two fishing rods with cute magnetic worms to catch the fish. The fish float upright in the water and blow bubbles when submerged. Also great for developing communication and motor skills as well as early number work. Educational CD included.

First Friends at Home

16 1-5J



30100033 TOLO First Friends at Home

The First Friends at Home set provides an excellent starting point for talking with children about many different aspects of personal and social development. The set includes a house that opens up with a pull out garden, furniture and appliances, family and pets. The set also comes with an Educational Resource CD providing fun activities and lesson ideas. Educational CD included.



6 1-5J

First Friends Family

3010035 TOLO First Friends Family

This family set is ideal to learn something about family life and different generations. A perfect start to provide early language development, roleplay, understanding of relations and the initial awareness of their own personality. The TOLO First Friends Family consists of parents, grandparents, baby and a baby cradle.

3010047 TOLO First Friends on Wheels

A great set for interactive and imaginative play. The four First Friends characters are enjoying three different modes of transport. The pull back action of the Go-Kart allows it to speed along. All vehicles can be free wheeled and the characters are interchangeable with the vehicles.

3010090 First Friends Organic Farm

This lively, bustling organic farm is an ideal set for early years children to discover and learn about their favorite farm yard animals. This extensive set offers endless imaginative play opportunities, interaction, comparing and categorizing. Includes 22 elements.

First Friends on Wheels

7 1-5J



First Friends Organic Farm

16 1-5J



1010204
My Little Story

Out of ten cards with figures one title card and accordingly six further cards are chosen narrating a logical and ongoing story. Washable cards are stuck on with Velcro and therefore can be fixed in a small book, which is also washable. By doing this children have the possibility to create a small book covering a small story: pages are browsed and so story can be shown, narrated and explained.

There are five independent stories with 10 colored-coded cards each. Each story provides 6 logical sequences as well as two logical options as the final of the story. 50 washable cards (50 Velcro strips for sticking on the backside), 2 small books with 7 pages each (with Velcro straps for inserting the cards). Packaged in a wooden-box with lid, including manual. For children from 3 years up.

- **Range of use:** play and education, school, therapy, rehabilitation, senior-care

1072184
Grotto Grip

Eye and hand helper in an innovative design. The large, comfortable grip encourages proper finger placement every time. Covered finger spots and a partition make them virtually impossible to use incorrectly. For right or left hand use.

1010105
RoadRunner

The colored knobs are to be drawn to the right position following the various images of the sample booklet with the result of a matching figure. Following the lines and those of letters and figures is an important step in the process of learning to write.

Wooden board, 36 x 33,5 cm, massive wooden ball-feet for solid stand, 24 movable twin-knobs in 6 colors playable on both sides with the board in an upright or horizontal position that can be turned to any direction, booklet with sample-images.

1400877
Vario Wooden Puzzle

Three different puzzle tasks altering in challenge-levels. On one side the placements of the parts are default. On the backside the puzzle-parts have to be assembled freely without any specifications. On the backside the player must assemble the puzzle-parts upright and free-standing in a form of "3D". The board is a solid wooden frame, approx 30 x 27cm, with a playing field on the front-and backside each. 9 puzzle-parts made of glazed beech, 3 red, 3 yellow and 3 green (approx 8 x 8cm, diameter 1,5cm), for children of 5 years and up.

- **Learning values:** Perception, visual attention, motor skill coordination, identification, comparing, combining, visual memory, dexterity, concentration, patience
- **Range of use:** play and education, therapy



Each story includes two logical options as the final of the story

«My little story»



RoadRunner



Vario Wooden Puzzle

Grotto Grip Handhelper



Blow Lotto



1502006
Blow Lotto

A unique, highly amusing game: the players take turns at blowing the ball from one hole to another, which requires control of the direction and speed of the ball. Sturdy frame, 22 x 22cm, height 10cm, 1 table tennis ball, 1 board with animal-motives on each side, 1 board with a trace on each side, 36 tokens in a cardboard box with extensive manual. Coaches command of breathing, motor skills of the mouth, lip-muscles, for 1 – 2 children of 3 years and up and adults.

1502005
Turbino

Turbino is an exciting blowing game. It is easy to set the propeller into motion, but not as easy to blow regulated in order to make the propeller stop at a certain field. Command of breathing and language skills are advanced in a playful way. Plastic-table with a propeller, 1 both-sidedly printed picture-circle for two different difficulty levels, 2 fabric bags each with 10 grey and orange colored rubber rings. With instructions, for 2 children from 4–12 years. Sturdy cardboard box for storage, 22 x 22cm.

1010198

The Senses Game

Identifying and distinguishing different senses: sight, sound, taste, smell and touch. For 1 to 5 player in the age of 3 up to 7 years. Made of durable plastik, washabel. Box contains: 2 spinning boards, 5 individual boards, 35 cards

- **Learning values:** recognition, correlation, comprehension of the 5 different senses; sight, sound, taste, smell and touch; perception, sensitisation, language improvement
- **Range of use:** pre-school, kindergarten, primary school, therapy

Turbino



The Senses Game



1010156

MimiQ

Super fun educational cardgame for children from 4 years up, adolescents, adults, seniors, for 2 to 4 players. MimiQ is a very fun game to encourage and exercise mouth motor skills. Each player should try to get a trump of three identical cards by using facial expressions to ask for cards from the other players. If the player do not have the requested card, he letknow the asking player by sticking out his tongue. 33 MimiQ-cards, card size: 9 x 6 cm, playing time: approx. 10 - 20 minutes, game rules in 7 languages, carton packed

1010118

Storm in a word

Game for language improvement and speech therapy. For children from 4 years up, for 2 to 6 players.

This game is especially developed exclusively for the German language.

MimiQ



Storm in a word



WhisperPhone

WhisperPhone is an acoustic voice feedback headset that enables learners of all ages to focus on hearing the sound that makes up words (phonemes) more clearly as they learn to read, spell or process language aloud. WhisperPhone is fun and easy to use, and research has proven that users can hear phonemes ten times more clearly when they are wearing the WhisperPhone! That means that they can hear themselves better over background noise, and they can focus better on what they're learning.

WhisperPhone works simply and effectively. When they speak, their voice is conveyed directly into their ear so they can hear their voice more clearly. This creates an improved signal-to-noise ratio, which means the user hears their voice better over all background noise.

1010136

WhisperPhone Headset, junior (1 phone 1 Headset)

WhisperPhone Headset has a practicable headband which should be wrapped behind the head to keep the phone properly on ear. Like this, hands are free to hold a book for reading. With the orange ring the opening can be pivoted near to the mouth. Phone approx. 17 cm long.

1010137

WhisperPhone Element (1 phone)

This handheld WhisperPhone is ideal for helping young learners develop their reading and spelling abilities and for developing new language skills. Perfect for early learners and the tactilely sensitive who prefer to hold their WhisperPhone. The orange ear pad can be rotated for personalized comfort. Phone approx. 17 cm long.

1010138

WhisperPhone Duet (2 phones, 1 tube)

The perfect tool for paired reading exercises by encouraging students to work together and help each other learn. Also useful for one-to-one time with teachers, tutors and speech therapists. WhisperPhone Duet keeps classrooms quieter by creating an acoustically-clear connection between two readers. 2 phones in one size fits all, connected with an expandable tube (max. length up to 120 cm), dishwasher safe. Phone approx. 22 cm long, tube length from 40 cm to 120 cm.

1400833

Language Improvement Set 1

Nine playing pieces with animal images as a supplementary for LoGeo or to play in an independent way. Packed together with task definitions into the blue folder (22 x 22cm). It's all a matter of recognition of relative positions, correlation, language improvement, memorization, realisation of visual information.

WhisperPhone Headset



WhisperPhone Duet

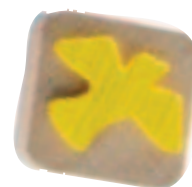

Language Improvement Set 1

Our child-oriented, didactic games, made of wood, provide a high play value, varied learning content and learning objectives and convince by their excellent workmanship and beautiful look. The focus is always on stimulating play and long-lasting fun, while at the same time important areas to be promoted in children's development are playfully supported and stimulated. The product portfolio includes matching games, mental games, dexterity games, tactile games, magnetic games, games for language development, game tables and wall elements. All games are made in Germany from impeccable quality materials - with a few exceptions - and meet all safety standards and norms.



Via Mobile

- Eye-hand-coordination
- Fine motor skills
- Left-right-coordination
- Senso motor skills
- Communication



Via Ronda

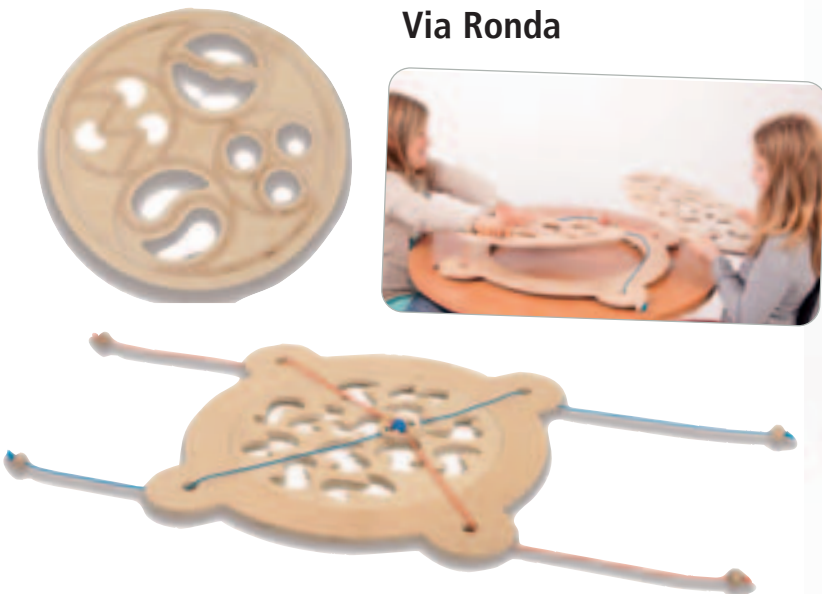

Via Mobile • Via Ronda • Via Maxima

All three high-quality games convince of their nice appearance, good workmanship in Germany, educational value and are practical to handle. By means of the cords on the side of the games either the wooden knob, wooden disc or marble have to be skillfully led via the paths between the openings of various sizes and shapes. If they fall through any of the holes, they are collected safely in the blue cloth working as drop-net (Via Mobile and Via Maxima). If the cords are held crosswise left and right cerebral hemispheres are activated stimulating ambitions and still the game leaves a lot of fun. Naturally 2 or even 4 children (Via Ronda) can play together and then, cooperation and communication are requested.

1010120 Via Mobile

Table-game of birch-plywood with foldable stand, 58 cm high, 48 cm wide, blue cloth as drop-net, 1 wooden disc 3 cm \square , 1 graphite-marble 2,5 cm \square , for 1 to 2 children from 3 years.

1010030 Via Ronda

Via Ronda is a vera interesting and exciting extension of the well-known playing principle. The table-game with 2 different inserts to change can be played by 2 or 4 players. The wooden knob is to be placed into the knobholder and has to be led over the small parts without falling through the openings. The 2 different inserts provide different challenging and can be changed easily.

Table-game of birch-plywood, 85 cm diagonal, 2 inserts each 50 cm \emptyset , 1 blue and 1 red wooden knob, 24 cm \emptyset , suitabel for 4 years and older.

1010121 Via Maxima

Giant game of birch-plywood with blue foldable stand, 120 cm high, 58 cm wide, 100 cm deep when in action, blue cloth, 1 wooden disc \emptyset 4,5 cm, 1 marble of ceramic \emptyset 4 cm. From 3 years for 1 to 2 children or more for playing in groups.

Via Maxima



1010235
EasyTip MAGNET

EasyTip as an exciting, challenging magnetic game! The round, high-quality game box made of beech wood contains 32 coloured balls, four of them always in one colour. The balls fit in matching recesses and are moved into the correct position with the firmly integrated magnetic pencil. 12 structured game templates vary the template patterns with 8 colors from simple to sophisticated. Both the number of balls and the beautiful colours are the ideal prerequisites for free, imaginative design of patterns.

Play box made of beech wood with plexiglass cover 13 cm Ø, 32 coloured balls, four balls each in eight colours. Magnetic pen (L 8 cm), which is firmly attached to the game box with an elastic band and can be securely fitted to the bottom of the box for storage.

- **Learning values:** Visual perception, recognition and assignment of colours and forms, fine motor skills, eye-handcoordination, assignment, oncentration, adroitness, coordinated thinking, strategic thinking

- **Range of use:** play and education, school, therapy, rehabilitation, senior-care

EasyTip

Two round play-boxes with transparent plexiglas cover, 12,3 cm Ø, containing 24 balls each in 6 colors, together with colored set of 12 cards, either packed in a little fabric bag (1010220) or packed in a stable box (1010240), incl. instructions. The coloured balls have to be moved from below with the fingertips to the appropriate position. The images start off clearly and easily and run up step by step. For one or two players, together or one come off as a winner, from 4 years up.

1010220 EasyTip Set of 2 in fabric bag

1010240 EasyTip Set of 2 in box

- **Learning values:** Fine motor skills, eye-handcoordination, recognition and assignment of colours and forms, concentration, adroitness, tactile perception

- **Range of use:** play and education, school, therapy, rehabilitation, senior-care



32 coloured balls

**EASYTIP
MAGNET**



EasyTip MAGNET

12 structured game templates



EasyTip



1010240



1010220

Manhattan Tower coloured

Game board blue



Game board yellow



Game board red



1010280

Manhattan Tower colored, MDF

The coloured Manhattan Tower is as decorative as attractive with 3 different game board sides inviting children to make use of all of them.

- **Yellow game board** with a large version of famous game Tastoletto with 4 different tactile materials brings out the didactic-paedagogic orientation.
- **Blue game board:** children can play the beautiful large version of the wellknown strategy game «4 Wins».
- **Red game board:** the coloured turning spiral turns round the extensive zigzag path.

Three elements of scratch-resistant MDF-wood, surfaces coloured in blue, red, yellow, each 82cm high and 60cm wide, assembled to a large triangle framed by edgings of fine beech wood, diameter of the tower ca. 50cm. Massive wooden ball feet guarantee a solid stand and still allow the system to be moved easily. Each element is a closed play unit, for 1 to 6 children, from 18 months.

- **Learning values:** fine motor skills, eye-hand-coordination, recognition and assignment of colours, correlation, concentration, adroitness, graphomotor-process, strategical thinking.
- **Range of use:** play and education, therapy, rehabilitation, senior-care, waiting zone.

1010104

Manhattan Tower

Manhattan Tower is a very beautiful play-tower in triangle-form. Several children can play, learn, discover and try out at the same time.

- **Game board 1:** The colorful RoadRunner-play
- **Game board 2:** Large Magnet Rallye-play
- **Game board 3:** Extensive zigzag path with colored turning-spiral

Three elements of birch-wood, each 82 cm high and 60 cm wide, assembled to a large triangle framed by fine beech-wood. Massive wooden ball-feet guarantee a solid stand and still allow the system to be moved easily. Each element is a closed play-unit with all loose parts fixed in place inside the system. For 1 to 6 children from 18 months.

- **Learning values:** fine motor skills, eye-hand-coordination, recognition and assignment of colours, correlation, concentration, adroitness, graphomotor-process, strategical thinking.
- **Range of use:** play and education, therapy, rehabilitation, work with elderly people, waiting zone.

Manhattan Tower



1010215

Go 4

The classic social game in an extra-large, high quality version and a new attractive styling of the playfield. The beautiful easy-to-grip and pleasant-to-touch figures are assembled in a charming trianglehome, the wooden play-board of excellent finish with rounded corners furnished with a hole to hang up the board in order to save space and for nice decoration. After the game figures and dice move into the small jute-bag to be stored.

Wooden play-board, oversize 50 x 50 cm, 16 play-figures of massive wood (6 cm high, 33 mm diameter) plus one big wooden dice (23 cm x 23 cm) in a fabric bag, altogether packed in durable folding carton box, for 2 -4 players from 3 years.

- **Learning values:** Fine motor skills, eye-hand-coordination, recognition of colours, correlation, understanding of game-playing, concentration
- **Range of use:** play and education, school, therapy, rehabilitation, senior-care, waiting room



Go 4



1400820

Jakolino

The beautiful intensive colors green and purple in combination with shiny beech-wood and the geometric forms -square, triangle and quarter-circle- result in numerous new, organic designs. The booklet showing images in 1:1 scale leads from plain forms with 4 dices only to highly demanding figures of 3-dimensional character and encourages users to create shapes following ones own imagination. For this purpose the booklet keeps three extra pages on hand. Ideally designed to complete existing, familiar materials.

16 bi-color wooden dices, 3 x 3 cm, play-frame of beech-wood, booklet with numerous images to be matched in 1:1 size, packed in solid storing carton-box with 24,8 x 24,8cm, for 1 - 4 children from 4 years up.

- **Learning values:** Fine motor skills, eye-hand-coordination, recognition and assignment of colours and forms, correlation, ability to combine
- **Range of use:** play and education, therapy, rehabilitation, senior-care

- **Eye-hand-coordination**
- **Fine motor skills**
- **Recognition and assignment of colours and forms**
- **Tactile perception**
- **Concentration**

Jakolino



1010223

TipExpress

The round play-boxes are shaken with the result of coincidental images showing the balls at different places each time. All players start copying the new picture by inserting the small colored circles into the round moss rubber boards. 24 circles - 4 of each color - have to be spread over 37 holes matching the figure to be copied. Mind you, for good results you better follow a wise strategy! 6 bi-color, round moss rubber boards, ca. 25 cm Ø, one side black only, the other one in 6 different colors, with 24 cut-out circles of ca. 2 cm Ø in red, green, blue, yellow, orange and purple, 2 round play-boxes made of plastic with transparent Plexiglas™ cover, packed in solid blue storage carton, instructions.

1010150

Card holder Motive

At first glance this special card holder provide its function: The rear panel with stylized card outlines gives excellent hold for all cards and the wide interspace makes it easy for small children or people with fine motor deficits to put cards into the card holder.

Made of natural birch plywood the card holder is manufactured in classical tradition of wooden art in a small workshop in the Erzgebirge. Can be used for pictures and photos, too. For children from 2 years, 40 cm long, 7 cm wide, 12,5 cm high, weight 175 g.

TipExpress



Card Holder Motive





PanTastino®

PanTASTINO und PanTASTINO corpo
A game for touching, recognizing and reminding

Pantastino practises, exercises and develops the sense of touch and three dimensional imagination. To recognize and to remember are the basic ideas of all matching games («memory games»). Pantastino leads these learning contents into the third dimension and makes them physical tactile.

The players feel and recognize not only the quality of the surface and material - solid beech wood, sanded and untreated with precise milled lines and figures - but palpate simple to complex figures. Players have to imagine and visualize these figures up to their inner eye. Compared to pure optically detecting and recognizing Pantastino requires an integrated performance of sense of touch and of skill and imagination.

Of course Pantastino can be played in the really classical way as a «memory-game», which encourages and stimulates imagination. More attractive and more challenging are the covered versions of different touching games, provided with playing instructions, easy-to-understand.

For little children from 4 years up Pantastino can already be used in the uncovered version as an educational game to encourage palpation, recognizing and assignment.

1100310
PanTastino series A

12 round beech wood pairs with clear geometrically and organic lines and figures. Solid beech wood, sanded and untreated, 60 mm Ø, approx. 15 mm thick, packed in carton, with fabric sack for practical storage.

1100311
PanTastino series B

12 round beech wood pairs with entirely geometrically and organic lines and figures. Solid beech wood, sanded and untreated, 60 mm Ø, approx. 15 mm thick, packed in carton, with fabric sack for practical storage.

1100312
PanTastino series A + B

24 round beech wood pairs (series A und series B) Solid beech wood, sanded and untreated, 60 mm Ø, approx. 15 mm thick, packed in carton, with fabric sack for practical storage.

1100313
PanTastino corpo

12 square beech wood pairs with extra deep milled motives. The precise and properly technical realisation guarantees a special tactile experience. Solid beech wood, sanded and untreated, 60 x 60mm, approx. 15 mm thick, packed in carton, with fabric sack for practical storage.

1100319
Wooden box for PanTastino

Practical and handsome storage-box made of wood with a sliding lid for 24 round or square PanTastino stones. The blue vanished bottom points up the special handcrafted design of the beech wood. Measures: 30 x 35 x 6,5 cm.



Serie A



Serie B



PanTastino® corpo®



Wooden box for PanTastino®



1010359 Voezie - The TactileSense of Touch

(based on an idea by Lennart Woortman)
 16 beechwood elements with geometric patterns on the upper surface. The game intention is to piece together fitting patterns, so that 8 complete figures are combined. Figures are always divided symmetrically. Each figure is made of a different material, which has to be felt and/or recognized. There are materials with similar material texture and there are some with divergent material texture. Single patterns are differentiated as well with the result that numerous game variations with different types of difficulty are given.

The feature of Voezi are the big wooden elements with handles which are easy to grip. Small children and people with minor grasping functions are enabled to play with and having senses of achievement.

- **Learning values:** tactile and visual differentiation, recognition and assignment of colors and forms, here especially geometric forms, recognition and arranging of positions and form to each other, fine motor skills, eye-hand-coordination, correlation
- **Range of use:** play and education, school, therapy, rehabilitation, senior-care

Big wooden-puzzles

Two nice, appealing pictures of to well-known painters to be patterned with stable wooden-puzzles. Accurate and proper accomplishment, all puzzle pieces 9 x 7cm are easy to grab, nice resulting is ensured. Every puzzle comes with a poster in original size which can be used as a pattern. Puzzles are very tangible for child's hand and even for young people and adults in therapy or elderly people. 50cm x 40cm, 48 pieces.

1101005 Van Gogh - Sunflowers 48 pieces

1101012 Monet - Bridge of Argenteuil 48 pieces

- Recognition and assignment of colours and materials
- Recognition and differentiation of geometric forms
- Fine motor skills • Correlation
- Tactile and visual differentiation
- Recognition and arranging of position and form to each other



Voezie - The TactileSense of Touch

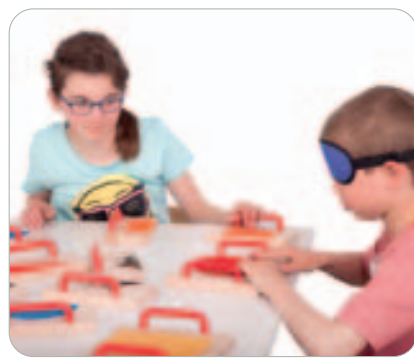

Giant Wooden Puzzles



1400832
LoGeo

Starting with plain images the game leads step by step to more challenging exercises up to real brain-teasers. A key for control and confirmation is included. To develop more exercises proves the full fascination of this game for broad minds! Educational game, ca. 20 x 15 cm, 9 rectangular blocks of fine beech-wood with 3 different geometric forms and colors, extensive and detailed booklet with instructions and plenty of images, packed in a solid storing cartonbox. For children from 3 years (easy images) to adults (advanced images).

- **Learning values:** Recognition and assignment of colors and forms, coherent thinking, ability to combine, recognition of correlations
- **Range of use:** play and education, school, therapy, waiting room, senior-care

1400861
LoGeo Giant Version Wall Unit

This is the big wall-version of the well-known LoGeo, the great strategy and mental exercise play, optically attractive and of motivating nature.

Big game in upright oval form, ca. 63 x 77 cm, scratch-resistant MDF-wood in yellow, 9 square blocks of beech-wood in natural color, 10 x 10 cm with coloured, geometric forms and magnetic adhesion, instructional booklet with numerous images integrated into the board. Inclusive fastening kit. For children from 3 years to adults, for one or more players.

- **Recognition and assignment of colours and forms**
- **Fine motor skills • Concentration**
- **Coherent thinking**
- **Ability to combine**
- **Logical thinking**
- **Recognition of correlations**

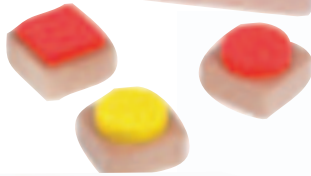
LoGeo

LoGeo Giant Wall Unit

77 cm

1011400
Doku-Mag
 Utility Patent No. DBGM 202007006735.6

Doku-Mag - a magnet game covering a wide range of different game contents and challenges by containing 14 different patterns. The closed system has a transparent covering plate and keeps always 81 colored balls ready to play. By using the two of the magnetic pins and depending on player's ages and skills various figures, logical sequences and Sudoku-riddles can be placed, «Tic-Tac-Toe» or «Merels» is playable as well. Additionally, Doku-Mag contains two blanc-cards for annotating & hand-lettering or pattering (template).

«Playing field» made of stable, transparent Macrolon-plates in a wooden-frame (42 x 33,50cm), two integrated magnetic pens (by non-usage pens can be docked at the frame). 81 coloured balls inside the closed system (nine colors each nine times) and 14 patterns for exchange made of washable, unbreakable plastic-material, printed on both sides:

- 6 patterns «figure», color-dots
- 6 patterns «figure», color-/number-coding
- 6 patterns «logic», logical sequences
- 6 patterns «Sudoku»
- 6 patterns «Tic-Tac-Toe»
- 6 patterns «Merels»
- 2 blanc-cards

Including manual, packaged in a stabile box. For children from 5 years up, teenagers, adults and elderly people.

• **Learning values:** Fine motor skills, eye-hand-coordination, perception and correlation of colors and forms, recognizing regularities, adroitness, mathematic basics, logical reasoning, flexibility, learning ability and receptivity, brain-training, fine-differentiation

• **Range of use:** play and education, primary school, school, therapy, rehabilitation, waiting room, senior-care

Official website: www.dokumag.com



12 Figures

6 Logical sequences

6 Sudoku Puzzle

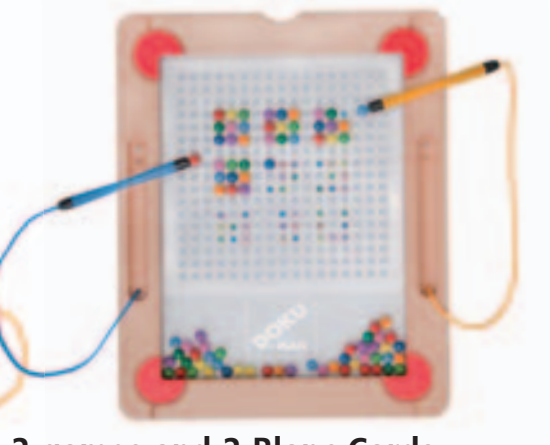
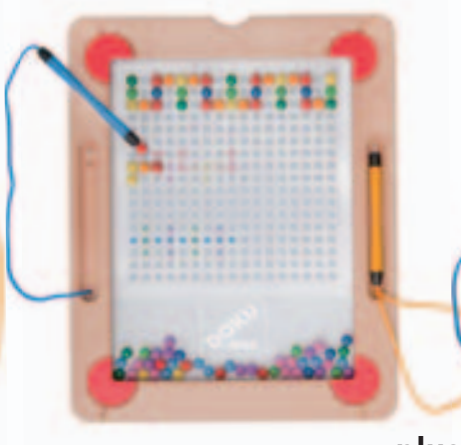

plus 2 games and 2 Blanc Cards

Magna Disc



Magna Disc 4

Magna Disc

The basic idea of this game is predicated on the physical phenomenon, that magnetic poles either affect magnetic adhesion (polar) or magnetic repulsion (homopolar). If the magnetic discs are laying on their flat side no one can decide which will be the reaction of any side when putting them on the wooden base: will the disc fall down on the already existing disc without any distance (poles adhere) or will it stay above with a remarkable distance (poles repel)? The outcome of this are very exciting, interesting play-versions. The white blank cards are washable and can be used for basic arithmetic operations, which can be created with according magnetic discs.

- **Learning values:** recognition of colors, differing of colors, correlation, visual perception, fine motor skills, concentration, realisation of coherences, basic principles of magnetism, of arithmetic, visual performance
- **Range of use:** pre-school, kindergarten, therapy, rehabilitation, work with seniors

1010196

Magna Disc 4 for 4 players, in box

4 wooden base for putting the magnetic discs on, 40 magnetic discs in ten different colours, 12 colourful pattern cards, 8 white cards to write on with an overhead marker, including extensive instruction for different play variations.

1010197

Magna Disc 2 for 2 players, in box

2 wooden base for putting the magnetic discs on, 20 magnetic discs, 12 colourful pattern cards, 8 white cards, including instruction for play.

For more Magna Disc items for supplementing and/or enlargement please see latest price list.

1010173

Magna Bands

Magna Bands is an innovative magnet game with coloured rubber bands. According to different patterns bands are stringed to serrated, magnet wooden boards. While stringing the bands it has to be considered to place them below or above other bands or to certain spikes. Completed wooden boards are placed on the big magnet table thus a nice, big and symmetric image is given. Fine motor skills, concentration, visual and spatial perception are developed. 1 magnet table (25 x 25 cm), 4 magnet wooden boards, 6 (18 x 18 cm) and 8 small pattern cards (11 x 11 cm), 64 rubber bands in 9 colours, delivered in decor box. For 1-4 players (single or group games), 3 years and older.



Magna Bands

magna Bands



**1010202
Magna Sticks 1**

Metal pieces in different shapes can be build up on the large magnet base. Due to the high magnetic pull all elements can be build upward in a significant way. The model cards show 9 different models to copy, but children also can build their own models according to their imagination. The game variation allows 2 to 4 players to build as many elements as possible on or up a basic element. The one who has a steady hand and is acting more skilfully than the other teammates is the winner.

For 1-4 players from 4 years up and older. Single game and group game, incl. instruction.

Content: 1 large magnet base, 18,5 x 13,5cm (magnet field: 14 x 9cm), weight 550g, 41 metal pieces in different geometric forms and shapes (e.g. rectangular piece 5,5x3,5cm, small square piece 2,4x2,4cm) and different long metal rods, 9 model cards.

**1010203
Magna Sticks 2**

For 1-8 players from 4 years up and older. Single game and group game, incl. instruction.

Content: 2 large magnet bases, each 18,5 x 13,5cm (magnet field: 14 x 9cm), 821 metal pieces in different geometric forms and shapes (e.g. rectangular piece 5,5x3,5cm, small square piece 2,4x2,4cm) and different long metal rods, 9 model cards.

• **Learning values:** visual and spatial perception, fine motorskills, three-dimensional realization of the models, hand to eye coordination, concentration, introduction to the characteristics of magnets

• **Range of use:** pre-school, kindergarten, therapy, rehabilitation, work with seniors

1010176 Magna Shapes

Each player receives a large magnetic board and four small magnetic boards. One of the pattern is placed in the center of the table. Each player arranges their board according to the pattern. The first player to arrange their board receives the pattern card. The player that collects the most pattern cards is the winner. Develops visual perception and concentration. 4 magnetic boards (24 x 24 cm), 16 magnetic boards (11 x 11 cm) 64 magnetic shapes, 24 pattern cards in decobox. For 1 to 4 children from 3 years.



- Visual and spatial perception
- Fine motor skills
- Three-dimensional realization of models
- Eye-hand-coordination
- Introduction to the characteristics of magnets



Magna Sticks 1

Magna Sticks 2

Magna Shapes

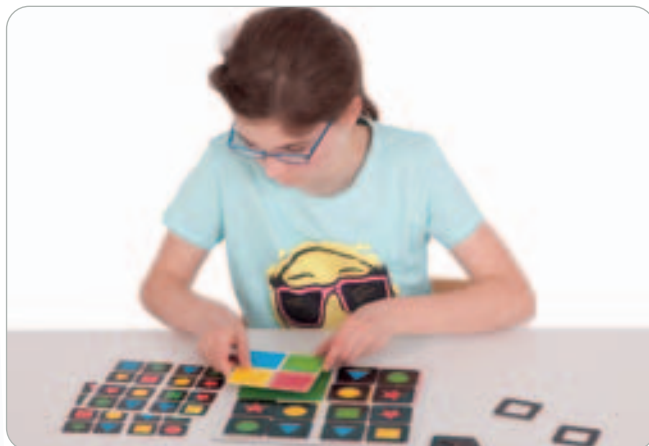



MagPad



- Eye-hand-coordination
- Fine motor skills
- Concentration • Adroitness
- Perceverance
- Understanding of magnetic phenomenon

1010166 MagPad

This exciting magnetic game is suitable for young and old. There are 714 small ironballs in the black board which appear as if by magician's hand leading the magnetic top of the pen over the board. Twelve templates allow children easily to build figurative pictures. Alternatively pattern and figures can be build free. The balls disappear from the surface area when you stroke the pen flatly over the board.

With its neutral colour MagPad is ideal for the work with elderly people. for 1-2 players from 3 years up.

Board: 31 x 25 x 15 cm with 714 iron balls, one magnetic pen, 6 template cards printed on both sides (16 x 11 cm).

• **Learning values:** Eye-hand-coordination, fine motor skills, creativity, visual perception, grapho-motor skills, concentration

• **Range of use:** play and education, therapy, school, work with elderly people, waiting room

1400891 Tetroloino

Tetroloino is an exciting magnetic-game for the young and the young at heart. Like the famous computer-game the geometric parts have to be directed without space in a determined playground. The magnetic pens are as helpful as fine-motor skills, assignment abilities and tactical skills. The closed play-unit enjoys all the advantages: nothing is disappearing, everything is tidy and always at hand. Ideal for play and education, school, therapy, work with elderly people, waiting zones. Very stable beech-veneered board with transparent cover of plexiglas and a 12 mm frame made of coated MDF-wood, 44,5 x 34 cm. Two strong magnetic-pens and 18 geometric forms in 6 sizes and 6 corresponding colours.

1010110 Magnet Rallye

The balls are drawn from the base on each side through the winding, maze-like paths towards the goal in the center of the playfield by using the slate-pencils. Playing with two turns the game into a challenging rally. It can be varied by changing the points for start and goal or bringing the board into a slant position to make it more difficult to play. Wooden play-board, 40 x 34 cm, with transparent cover of Plexiglas, 14 small balls of metal in 2 colors, 2 strong magnetic-pens. For 1 to 2 children from 3 years, instructions.

• **Learning values:** Eye-hand-coordination, fine motor skills, concentration, adroitness, perseverance, understanding of magnetic phenomenon, grapho-motor skills

• **Range of use:** play and education, therapy, school, work with elderly people, waiting room

Tetroloino



1010380

Ball Run MagniRoll

A transparent, flexible ball run to build up, to repositioned, to be tested and to be experimented! MagniRoll consists of transparent, stable acrylic tubes, which can be placed and arranged in various ways to a thrilling and innovative marble run. Each tube is connected firmly to a plastic clip including two inserted magnets, which can be linked to the stand's magnets. Diverse heights, inclinations, directions and distances encourage varied roll ways for the balls. Tubes can be positioned next to each other, so that ends contact each other or standing with distance to each other. That is consequently a challenge as the balls have to overcome a vertical interval and shortly hurtle through the air. Furthermore two tubes can be placed to each other at an angle of 90 degrees, so that a closed connection is given. There are multiple options, which can be combined. It is thrilling and challenging to try out, 'what' works, how does it work, which incline is needed and which distance the balls cover from start to end. At the end point a small cushion is placed to prevent the balls from rolling away. Each ball has a different rolling behaviour and differences can be experienced through play and experimenting. Who wants to know for sure can take the time, which different balls need for the same track. Acrylic tubes can be mounted additionally to all magnet-suited surfaces (refrigerators, railings, and so on).

- 5 acrylic tubes with bevelled ends and clip with magnets (40 cm long, Ø 3,8 cm)
- 2 coated magnets per clip, magnets are inserted at two ways
- 5 stands with powder-coated iron rods with a massive wooden base (Ø 12 cm) and a massive wooden knob for easy replacement made of clear varnished beech tree
- Delivery with 2 wooden balls • 2 kork balls • 1 rubber ball • 1 collecting ring made of wood
- For children from 4 years, teens and adults.

• **Learning values:** Visual perception, visual thinking, spatial awareness and orientation skills, discerning relations, basic experiences with magnetism, creativity, play fun, fine motor skills, eye-hand-coordination, capacity for team work, endurance, interaction and tactical thinking

• **Range of use:** Play, didactic and education, therapy, rehabilitation and for working with elderly



MagniRoll

New Design
Made in Germany



Ball Run MagniRoll

Magnetspieltisch Maus



Stift andocken to dock on pencil

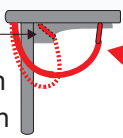

- nur von unten spielen!
- only play from the bottom!

1010127

Magnetic Play-table Mouse (Closed play-unit system)

The particularly interesting play-idea with pretty little mice searching bits of cheese has been created for 4 players. Each child chooses a coloured mouse and tries with the help of the magnetic pen in the same colour to store as many cheese as possible in it's target field. The reach of the ribbons is fixed to a certain limit. The movement as a result of the magnetic forces plus the invisible destination guide are exciting and challenging thus adroitness, concentration and patience are demanded. Certainly children can play free and just for fun with the elements of the magic table. Solid wooden table made of varnished beechwood with nonbreakable, coated composite panel (Dibond) with a durable transparent cover, 66 cm high, table-surface 76cm x 76cm. Payboard 58 cm x 58cm with 4 mice in different colours and 16 yellow wooden triangles as cheese pieces. 4 coloured magnetic pens, each to be stored behind the leaf-corner of the table. Weight: 18 kg, incl. assembly instruction and play instruction. Very stable with sturdy corner joints. High class workmanship emphasises the extra-polybenefit, (manufactured in Germany). The mice have to be moved with the pens from below - from under the surface - and by means of the mice push the yellow bits of cheese into the desired direction.

- **Learning values:** fine motor skills, recognition and assignment of colours, visual correlation, visual perception, local perception, motional coordination, concentration, adroitness, patience
- **Range of use:** play and education, school, therapy, rehabilitation, waiting zone, indoor-play-zone

- Eye-hand-coordination
- Visual perception and correlation
- Local perception
- Motional coordination
- Concentration
- Ability to combine
- Adroitness



tegu - Magnetic Wooden Blocks

Building a new world...with these magnetic and magical wooden blocks! Wooden blocks are part of the basic equipment in the fields of educational and motoric encouragement. The very special wooden blocks join together by the locked magnets inside. With this inovative feature planning, building, constructing and design become more exciting.

- Handmade, magnetic wooden building blocks in different, geometric forms
- Enclosed, invisible magnets in the inside of the blocks
- Every tegu magnetic wooden block is compatible with one another
- Each single building block element always fits together because of the mathematical calculated dimension
- FSC-certified hardwood from Honduras (sustainable production)
- Bright, friendly colours with safe, non-toxic, water-based lacquer finish
- For children from 3 years

• **Learning values:** Eye-hand-coordination, fine motor skills, assignment of colours and forms, creativity, capacity for team work, interaction, playing together, problem solving, storytelling

• **Range of use:** Play, didactic and education, therapy, rehabilitation, working with elderly people, play areas

3311006

tegu - Magnetic Wooden Blocks TINTS Set of 90

Introductory set in nice tinted colours available in functional box:

- Content: • 6 cubes • 14 high columns • 6 low columns • 14 Mega-planks • 8 long planks • 12 short planks • 4 small trapeze • 4 triangles • 2 parallelograms • 2 roboter heads • 8 wheels • 10 spirals

3311003

tegu - Magnetic Wooden Blocks TINTS Set of 130

Building set in nice tinted colours available in functional box:

- Content: • 16 cubes • 18 high columns • 12 low columns • 24 Mega-planks • 12 long planks • 12 short planks • 8 small trapezes • 8 large trapezes • 4 triangles • 16 wheels

3311005

tegu - Magnetic Wooden Blocks BLUES & FUTURE Set of 130 Building set with technical elements in modern blue and nature tones, available in functional box:

- Content: • 12 cubes • 16 long columns • 8 short columns • 20 Mega-planks • 12 long planks • 14 short planks • 4 small trapezes • 8 triangles • 6 parallelograms • 8 wheels • 4 racing wheels (Ø 6cm) • 2 propeller • 4 roboter heads • 4 low columns • 4 solar panels • 2 charging stations • 2 large roboter-elements (hexagonal)

3311004

tegu - Magnetic Wooden Blocks TINTS Set of 240

Building set in nice tinted colours available in functional box:

- Content: • 27 cubes • 32 high columns • 20 low columns • 31 Mega-planks • 22 long planks • 56 short planks • 8 small trapezes • 12 triangles • 10 parallelograms • 22 wheels

3311016

tegu - Set of 20 Magnetic Wheels

With 20 magnetic wheels all kind of different vehicles can be



Magnetic Wooden Blocks TINTS Set of 90



Magnetic Wooden Blocks BLUES & FUTURE Set of 130



Magnetic Wooden Blocks TINTS Set of 130



Magnetic-Wheels Set of 20



Models

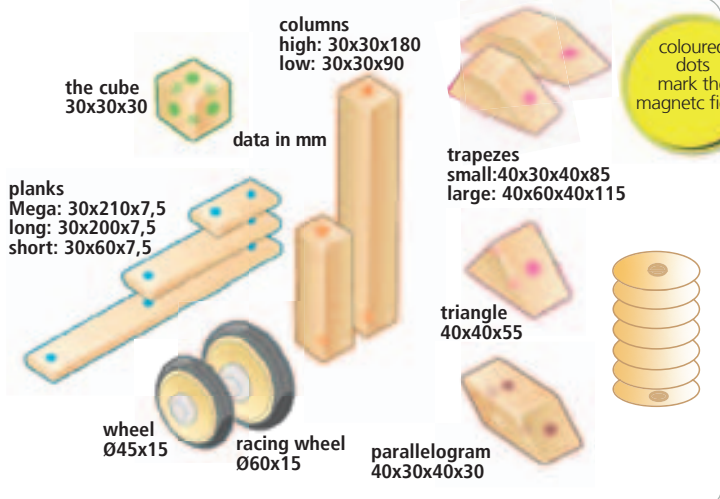

Magnetic Wooden Blocks TINTS Set of 240



TONGO-GO Steel Tongue Drums

TONGO-GO Steel Tongue Drum

A Steel Tongue Drum is a round hollow body made of steel. On the surface there are vibrating recesses (tongues), which are tuned tonal (scale system) and whose sound is amplified by the resonance body. The drums are very melodic and known for their relaxing sounds and ease of playing, which does not require any special technique.

Each child can select a model and start playing, the number of "tongues" is equal to the number of notes the instrument can produce. The steel tongues can be played with the hands or with padded mallets. Playing with the hands produces a gentle, calming, pleasantly vibrating sound. Playing with the mallets enhances the sound and resonance and makes the individual notes resonate beautifully.

Jakobs steel tongue drums for children are manufactured commercially in India. A not too high steel reed body with cut out tongues is professionally finished by hand, so that each tongue gets its special, correct scale tone.

The drums can be played in a sitting or standing position if they stand on a table or an appropriate surface. Older children and teenagers can also sit and place the drums on their thighs and play.

- The play on the steel reed drums promotes fine motor skills, here particularly smaller, purposeful movements of the wrists, hands and fingers are developed.
- Both playing with the hands and playing with mallets promotes eye-hand coordination and visual and haptic perception.
- The awareness of the connection between physical movement and the generation of sounds and tones is developed.

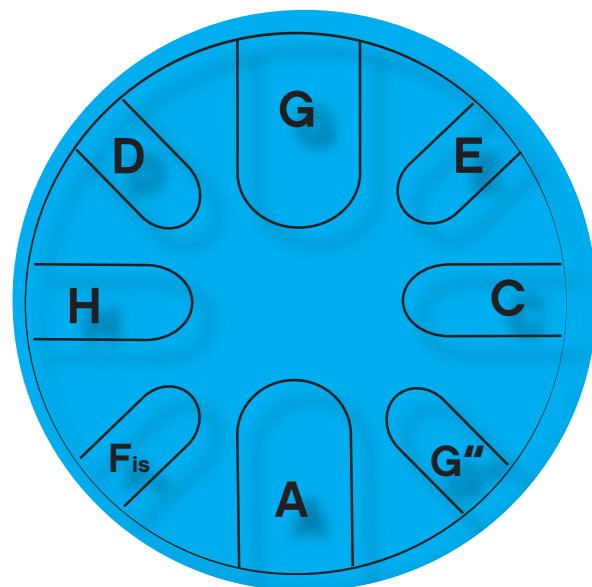
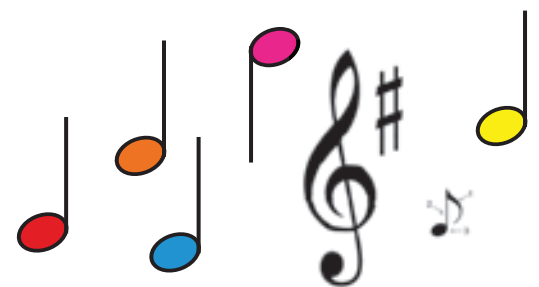

TONGO-GO Steel Tongue Drums

1010902

TONGO-GO Steel Tongue Drum 8" Mini

8 tongues, C to C" - C major scale.
Diameter approx. 21 cm, height 7 cm, weight 1.340 g.
Material: steel lacquered, colour: burgundy red.
2 padded mallets, 17 cm long.
Completely in a perfectly fitting cotton carrier bag with zipper for transport and storage.
Inclusive accompanying and instruction booklet with simple rhythm melodies, well-known children's songs and colour dots to stick on the tongues for playing with coloured notes.
Age group: 3 years and older.

1010900

TONGO-GO teel Tongue Drum 12" Large

8 tongues, G to G" - G-major scale.
Diameter approx. 33 cm, height 5 cm, Gewicht 2.320 g.
Material: steel lacquered, colour: blue.
2 padded mallets, 25 cm long.
Completely in a perfectly fitting cotton carrier bag with zipper for transport and storage.
Inclusive accompanying and instruction booklet with simple rhythm melodies, well-known children's songs and colour dots to stick on the tongues for playing with coloured notes.
Age group: 5 years and older.

- The arrangement of the individual tones results in automatically areas for the left and right hand.

- For the training or the cooperation of the two hemispheres of the brain, for example, it is possible to play cross-over in a targeted way. Or the left hand takes over the movements of the right hand and vice versa.

- Playing with the Steel Tongue Drums provides a first understanding of tones, sounds, scales, rhythm and beat. The ear is trained, concentrated listening, understanding, coordination, memory and concentration as well as motor and social skills are developed and promoted.

TONGO-GO Steel Tongue Drum 8" Mini



TONGO-GO Steel Tongue Drum 12" Large

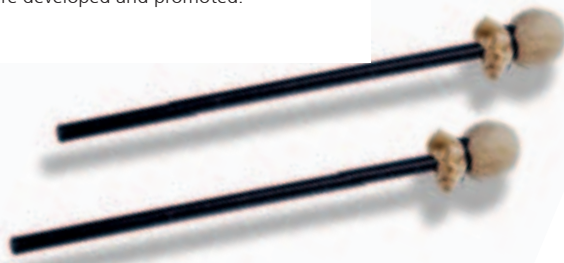

Wall Top

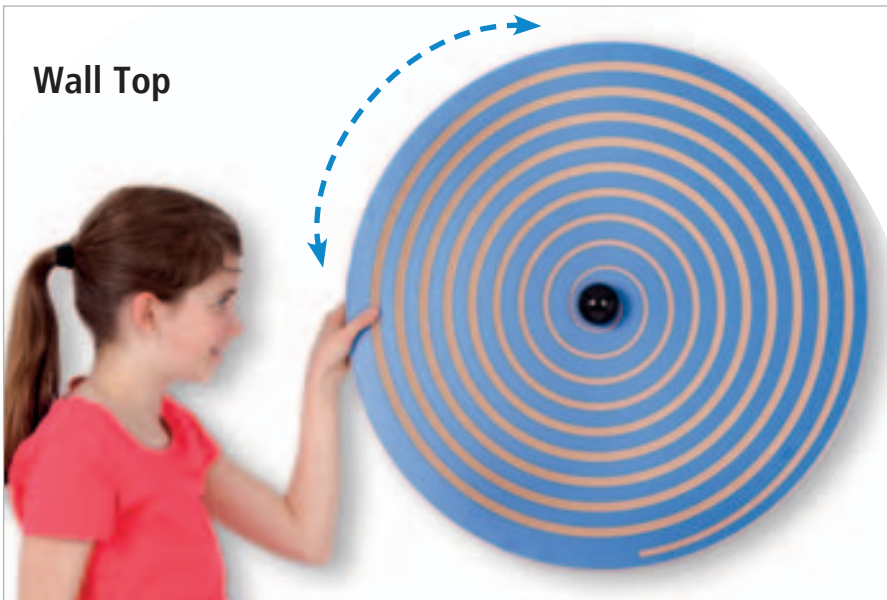

Wall Top

The big wall-tops can easily be spun just by one hand. Rotation and speed modify the various images and result in ever changing perceptual pictures with fascinating optical phenomenon. One round spinning wheel of color-coated MDF-wood, 63cm diameter, 12mm thick, safe fastening kit with solid ball-bearings makes the top go round smoothly and steadily. One side red, the other blue with distinct mould-cut lines. The massive black knob in the middle allows an easy and quick change of the sides.

- **Learning values:** visual and sensory perception, concentration, meditative relaxation, motivation.
- **Range of use:** play and education, therapy, senior-care, waiting zones, sensory perception, meditation.

1400822 Wall-Top Spiral

The blue side shows the spiral image, lines of a flower are drawn on the red side.

1400823 Wall-Top Wave

Wave on blue side, red side funnel-shaped.

1400824 Wall-Top Set

2 wooden tops 65cm Ø, with just 1 fastening kit. Items 1400822 and 1400823 add to totally four different images of perception.

Wall Top I Spiral

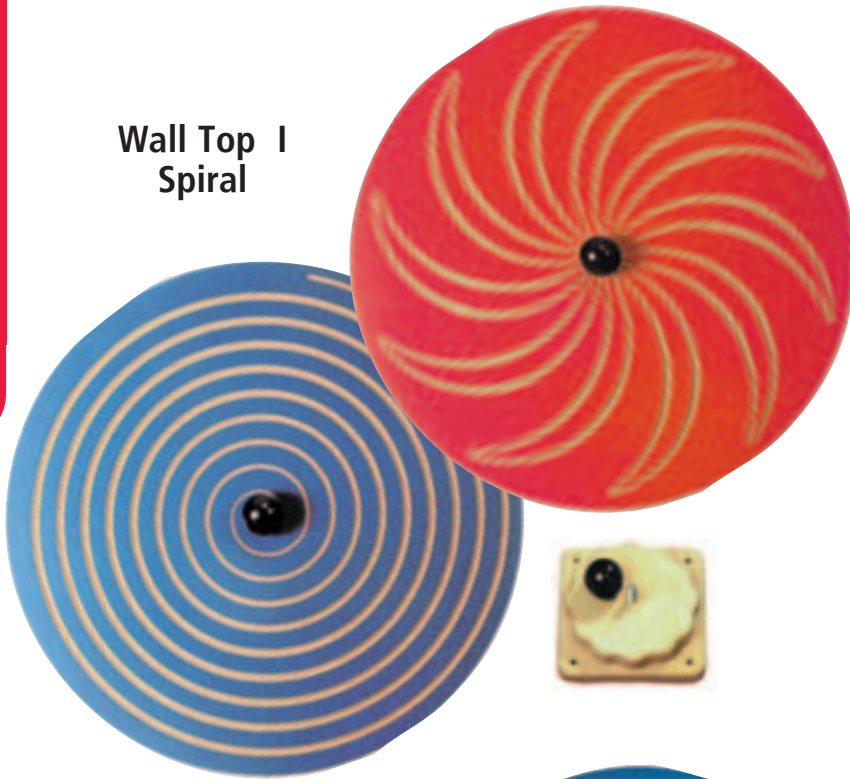

1400863

Wall-Top Triangle

A top in triangular shape, that's fascinating and results in quite exceptional ever changing perceptual pictures with optical phenomenon.

Spinning-wheel in triangular shape, made of MDF-wood with colored surface, 62,5cm diameter, 12mm thick, with mouldcutlines on front side, color green. Solid wall fastening kit with high-quality ball-bearing making it turn steadily and smoothly.

1400865

Wall-Top Labyrinth

To move the balls into the goal demands the right ideas, clever tactics, tryingout, discovering possibilities, developing strategies and keeping alert. Eventually it does work, an active challenge and full of enjoyment.

Spinning ‚wheel‘ - triangular shape - MDF-wood with blue surface, 62,5 cm Ø, 12 mm thick, with transparent cover of Plexiglas, with mould-cut maze on front side. Solid wall fastening with high-quality ball-bearing making it turn steadily and smoothly.

- **Learning values:** visual and sensory perception, concentration, meditative relaxation, motivation. (Blue Top additional: adroitness, eye-hand coordination, strategic thinking, patience.

- **Range of use:** play and education, therapy, work with elderly people, waiting zones, sensory perception, meditation.

Wall Top II Wave

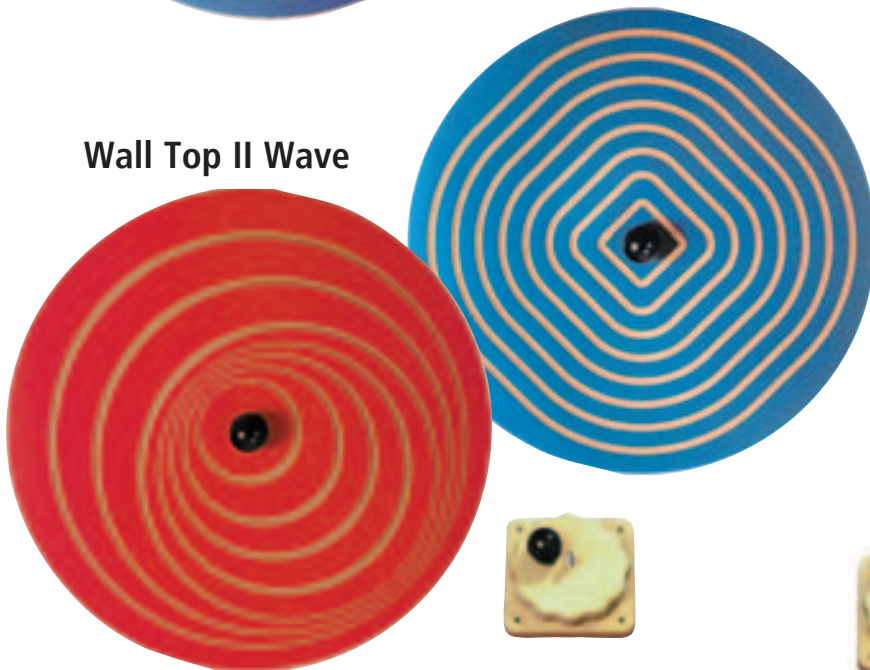

Triangel

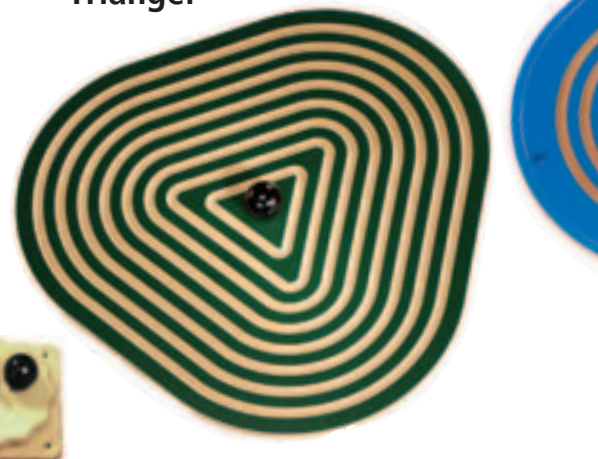

1400860

Wall Unit Travel in Europe

By means of the magnetic balls player can travel right across Germany, from top (north) to bottom (south), from left (west) to right (east) or diagonally - and who knows the name of our border country characterized with a typical symbol? The points for start and finish are in the north and south with sufficient parking rests on the way between, which are needed because the red couplings are extra harassments on the magnetic journey.

Big game in upright oval form, ca. 63 x 77 cm, blue-coated MDF-wood, metal balls in 2 colors, 7 red couplings (to be passed to the right direction!), transparent cover of Plexiglas, 2 slate pencils with strong magnets covered by felt. For 1 or 2 children from 3 years.

• **Learning values:** recognition and assignment of colors and forms, ability to combine, coherent thinking, recognition of correlations.

• **Range of use:** play and education, therapy, school, work with elderly people, waiting room.

1400861

LoGeo Giant Version Wall Unit

This is the big wall-version of the well-known LoGeo, the great strategy and mental exercise play, optically attractive and of motivating nature.

Big game in upright oval form, ca. 63 x 77 cm, scratch-resistant MDF-wood in yellow, 9 square blocks of beech-wood in natural color, 10 x 10 cm with coloured, geometric forms and magnetic adhesion, instructional booklet with numerous images integrated into the board. Inclusive fastening kit. For children from 3 years to adults, for one or more players.

**Wall Unit
Travel in Europe**



- Recognition and assignment of colours and forms
- Fine motor skills • Concentration
- Coherent thinking
- Ability to combine
- Logical thinking
- Recognition of correlations

LoGeo Giant Wall Unit

77 cm



Wall Units Blue MDF

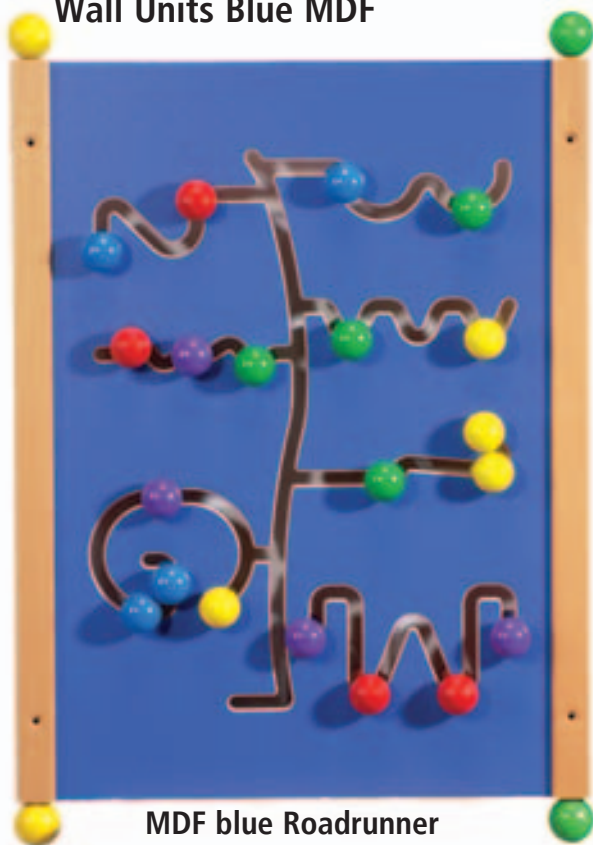

MDF blue Roadrunner

Eye-hand-coordination

- Recognition and assignment of colours and forms
- Fine motor skills • Assignment
- Ability to combine
- Adroitness
- Concentration
- Logical thinking

Wall Units blue

Wall units are attractive eye-catchers in all visitor- and/or incoming areas. They prove not only with their beautiful optics, but also with their high play and learning values. The closed systems are always ready to play and nothing get lost.

Scratch-resistant MDF-wood, surfaces coloured in blue, each 80 x 56 cm, closed play-units, stable distance holder to be fixed on 4 points, incl. fastening kit. For 1 or 2 children from 18 months.

1010251

Wall Unit blue MDF RoadRunner

The colorful Road Runner game with extra massive wooden balls in five colors, either as a decorative element on its own or brilliant eyecatcher, if several elements are hung up at the wall together as set.

1010261

Wall Unit blue MDF Zig Zag

On the large zigzag path the colored turning-spiral passes through a long journey, which is very nice to look at.

1010266

Wall Unit blue MDF Four Wins

The beautiful large version of the well-known strategy game "Four Wins" with 30 rotatable, square wooden cubes.

1010256

Wall Unit blue MDF MagnetRallye

Fascinating magnet game with durable magnetic -pens. The various winding paths have changing degrees of difficulty, which makes this wall-element attractive for children of any age.

- **Learning values:** fine motor skills, eye-hand-coordination, recognition and assignment of colours, correlation, concentration, adroitness, graphomotor-process, strategical thinking.

- **Range of use:** play and education, therapy, rehabilitation, work with elderly people, waiting zone.



MDF blue Zig Zag

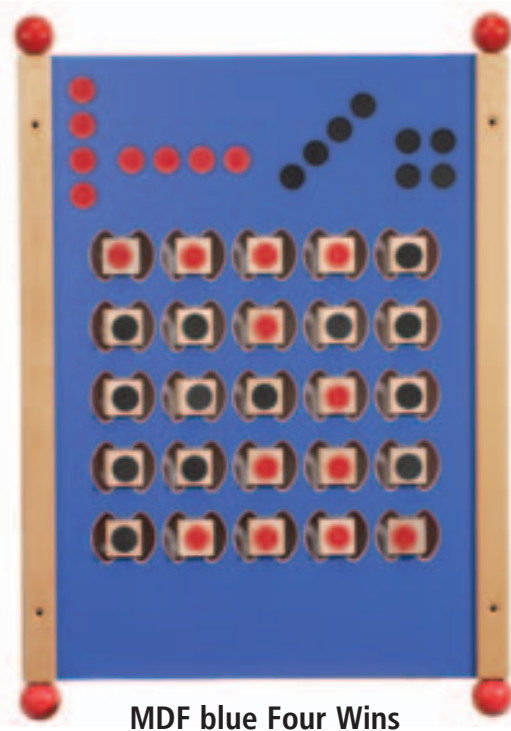

MDF blue Four Wins



MDF blue Magnet

Wall-Units nature (solid Wood)

Wall units are attractive eye-catchers in all visitor- and/or incoming areas. They prove not only with their beautiful optics, but also with their high play and learning values. The closed systems are always ready to play and nothing get lost.

The wall-elements are as decorative as attractive and inviting children to play and do guarantee play-ability any time. Each wall-element is a closed play-unit. Massive wooden boards in natural color, size 80 x 56 cm, to be fixed at 4 points, incl. fastening kit. For 1 to 2 children from 18 months.

1010265

Wall Unit Four Wins

The beautiful large version of the well-known strategy game "Four Wins" with 30 rotatable, square wooden cubes.

1010260

Wall Unit Zig Zag

On the large zigzag path the colored turning-spiral passes through a long journey, which is very nice to look at.

1010255

Wall Unit Magnet Rallye

Fascinating magnet game with durable magnetic -pens. The various winding paths have changing degrees of difficulty, which makes this wall-element attractive for children of any age.

1010250

Wall Unit RoadRunner

The colorful Road Runner game with extra massive wooden balls in five colors, either as a decorative element on its own or brilliant eyecatcher, if several elements are hung up at the wall together as set.

Learning values: Fine motor skills, eye-hand-coordination, recognition and assignment of colours, correlation, concentration, adroitness, graphomotor-process, strategical thinking.

• **Range of use:** Play and education, therapy, rehabilitation, work with elderly people, waiting zone.

Wall Units

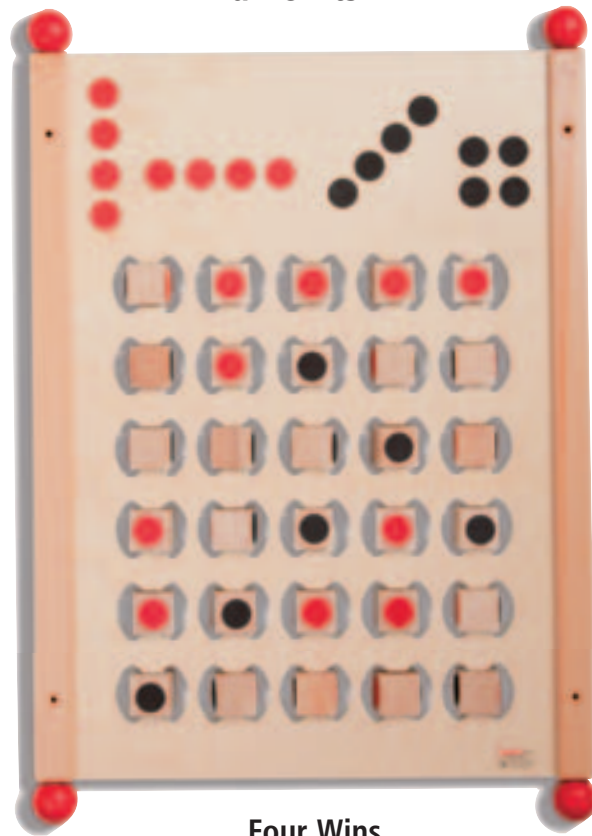

Four Wins

- Eye-hand-coordination
- Recognition and assignment of colours and forms
- Fine motor skills • Assignment
- Ability to combine
- Adroitness
- Concentration
- Logical thinking



Zig Zag



Magnet Rallye



RoadRunner

Wall Units Blue MDF

- realistic illustrations



Forest Animals with Pets

Wall Units Blue MDF

Wall units are attractive eye-catchers in all visitor- and/or incoming areas. They prove not only with their beautiful optics, but also with their high play and learning values. The closed systems are always ready to play and nothing get lost.

Scratch-resistant MDF-wood, surfaces coloured in blue, each 72 x 62,5 cm (different measures compared to wall units, page 114), solid wood borders, natural-colored with wooden knobs, closed play-units, stable distance holder to be fixed on 4 points, incl. fastening kit. For 1 or 2 children from 3 years up.

Realistic illustration of forest animals, farm animals and vehicles have to be puzzled of six squares with screenprint (7x7cm). The big playfield is filled with 24 wooden squares with magnets. The matching elements have to be selected and have to be pulled upwards into the frame with the magnet pens and to be arranged in the correct way to show a complete picture of an animal or a vehicle. The small batten under the frame shows all completed motives.

1400908

Wall Unit Vehicles

In each case 6 matching squares show a vehicle. Altogether 4 vehicles (truck, cabriolet, motorbike, tractor).

1400903

Wall Unit Farm Animals

In each case 6 matching squares show an farm animal. Altogether 4 farm animals (cow, chickens, sheep, horse).

1400907

Wall Unit Forest Animals

In each case 6 matching squares show an forest animal with its pet. Altogether 4 forest animals (deer, wild boar, fox, hedgehog) with pets.



Farm Animals



Vehicles

1400904
Wall Unit Tetrolino

This exciting magnetic game in which the geometric elements should be combined without any space in a determined playfield. In doing so you need the magnet pens and additional correlation skills, adroitness and tactical thinking. 24 geometric elements with magnets made of wood, shaped in 6 different forms and sizes, 2 strong magnet pens.

- **Learning values:** Eye-hand-coordination, fine motor skills, recognition of colors and forms, tactile perception, adroitness, concentration, tactical thinking, imagination, comparing.
- **Range of use:** play and education, therapy, waiting zone, visiting-zone.

1400829
Hand Top Set

As spinning top every top is spun by means of the solid half-ball on a smooth surface to fascinate with its ever changing perceptual pictures. Balancing the top in your hands the various metal balls inside the mould-cut lines require skilful hands. Played alone or in groups with proportional demand of fine motor skills. 2 wooden tops, Ø 25 cm, one side blue, the other red with 4 different mouldcut lines, half a ball of solid natural wood in the middle of each side, small metal balls of different sizes for balancing, packed in small fabric bag. For children from 3 years, to be played by one or more players.

- **Learning values:** fine motor skills, eye-handcoordination, visuel perception, concentration, patience, adroitness.
- **Range of use:** play and education, therapy, rehabilitation, sensory perception.

- Fine motor skills
- Eye-hand-coordination
- Visual perception
- Concentration
- Patience
- Adroitness



Wall Unit Tetrolino

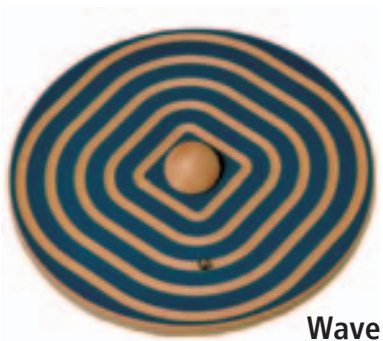

Wave

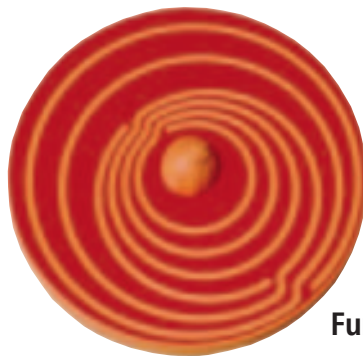

Funnel

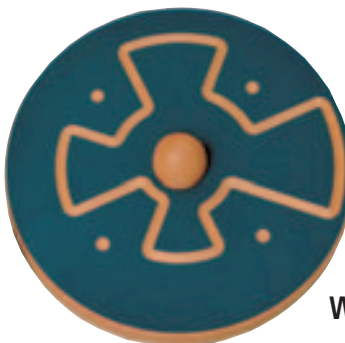

Wing

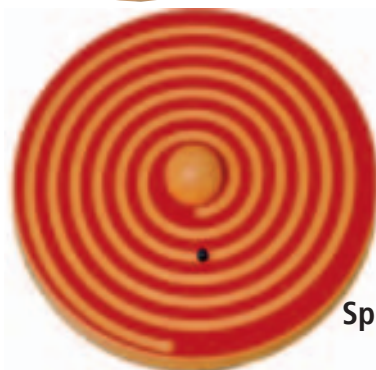

Spiral

Hand Top Set



Colour Palettes

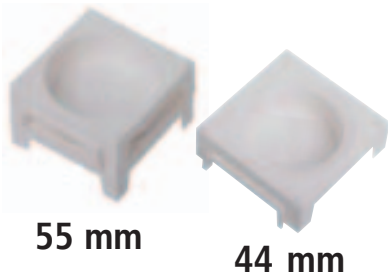

55 mm

44 mm



Colour Palettes

The handy color palettes in 2 sizes for small and large color trays can be used separately or combined, are easy to clean and pileable for storing. Only available in sets of 8 per size.!

1015050 Colour Palettes 44mm white, set of 8

1015051 Colour Palettes 55mm white, set of 8

Open Pencil Cases

Open pencil case of best quality plastic, ideal size, suited for pencils of all kind and for play figures, dices etc. 25cm x 12,5cm, 4cm high

1018000 Open Pencil Case blue

1018001 Open Pencil Case red

Iron Beads and Bases for Iron Beads

The small colored Ironing Pearls (5mm x 5mm) in 2 color-assemblies are perfect for creative and decorative handcrafting. The pearls are being stuck onto pencil palettes and ironed afterwards – due to the heat, the pearls combine to constant motives. White or translucent pencil palettes are available in different designs, motives and sizes.

1009229

Bucket of Iron Beads, assorted colours, 20.000pc.

1009232

Bucket of Iron Beads, pastel colours, 20.000pc.

1009211 White Bases for Iron Beads

Different motives, 3 large ones (each 16cm x 16cm), 4 small ones (each 7cm x 8cm).

1009212 Translucent Bases for Iron Beads

Different motives, 3 large ones (each 16 x 16cm), 4 small ones (each 7cm x 8cm).



Open Pencil Case



Assorted Colours

Iron Beads

pastel



Bases for beads translucent or white

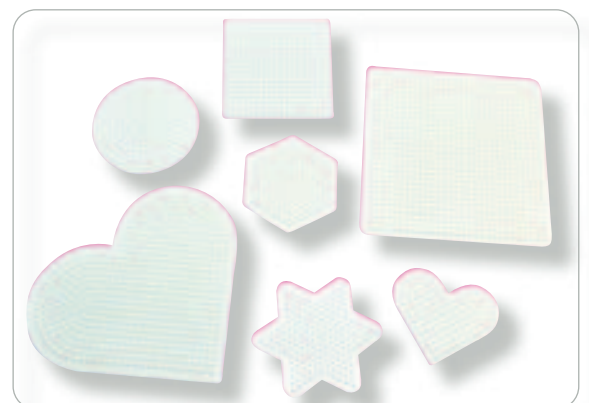

1009218

Wooden Beads 1 KG

The mix of wooden beads contains an extensive range of beads in different colours and forms. They are blue, red, yellow, light green, dark green, pink, purple, grey, natural, round, square, conical, ribbed, flat and in different sizes. Opening for threading between 3 and 5 mm. Threading of bracelets and chains and simple threading games improve children's creativity, fine motor skills and colour assignment.

Wooden Beads 1 Kg



XL-Iron Beads and XL-Bases for Iron Beads

The big colored Ironing Pearls (10mm x 8mm) are perfect for creative and decorative handcrafting. The pearls are being stuck onto pencil palettes and ironed afterwards – due to the heat, the pearls combine to constant motives. Translucent pencil palettes are available in different designs, motives and sizes (13-23cm high/wide).

• The XL Iron Beads are also available in the environmentally friendly organic version as ECO Iron Beads made from 100% sugar cane.

XL-Iron Beads

1009310

Bucket of XL-Iron Beads, 5000 pc. in bucket

10mm high, Ø 8mm

5000 pieces

1009311

ECO XL-Iron Beads, 5.000 pc. in bucket

10mm high, Ø 8mm, made from 100% sugar cane.

1009245

XL-Base for XL-Iron Beads square set of 4

The squares can be connected to one big square. 16 x 16 cm

1009244 XL-Base for XL-Iron Beads duck, elephant, rabbit

1009249 XL-Base for XL-Iron Beads bear, car, heart

1009258 XL-Base for XL-Iron Beads cat, dog, horse



XL-Bases for XL-Beads



ECO XL-Iron Beads

5000 pieces



For the very youngest dantoy has developed the toy line tiny. The entire series qualifies for the Nordic Swan Ecolabel, meaning that the toys are eco-friendly and do not contain harmful chemicals. The colours are clear – not loud or glossy – to create a tranquil environment for infants.



0+
m

tiny Teething Rings Set of 3



2006006

tiny BIO Teething Rings, Set of 3

The tiny teething rings are designed for babies and come in six amusing animals in a variety of tranquil colours. The various animals are designed to stimulate a baby's senses and focus on soothing the eruption of teeth. Colours and shapes according to stock.

2006011

tiny BIO Teether Ring Chain

The Teether ring chain can be e.g. attach to the stroller, cot or car seat. It promotes visual and tactile perception and the teething ring can help with teething From 0+ months, colours and shapes according to stock.



0+
m

tiny Teether Ring Chain



2006030

tiny BIO Play cups

Building and stacking cups in a set of 7 parts. Suitable for indoors and outdoors, approved for contact with food. From 6+ months.

2006035

tiny BIO FunCars Set of 2

Nice small game cars in a matte red and blue tone, which roll easily and comfortably. Suitable for indoors and outdoors and easy to clean in the dishwasher. From 6+ months.

2006971

tiny BIO Lunch Set

The lunch set consists of 94 parts and is suitable for indoors and outdoors. Ideal for roleplay or proper meals. Dishwasher safe and microwaveable. From 12+ months.

2006970

tiny BIO Sand Set

This large sand game assortment consists of 43 parts and is ideal for playing, exploring and learning in the sandbox. From 10+ months.



- sustainable bio-plastic from sugarcane
- made in Denmark
- contains no poisonous substances
- dishwasher safe
- 100% recyclable
- muted, natural colours



tiny Play cups

06+
m

tiny Sands set

10+
m



12+
m



tiny Lunch Set



tiny FunCars

06+
m



Dantoy has a new, with "I am Green" marked bioplastic range on the market, thus expanding the environmentally friendly range of plastic toys. At least 90% of Dantoy bioplastics are sugar cane - a sustainable one raw material - and is 100% recyclable. The Bio products from dantoy have the same qualities as the traditional plastic toys from dantoy.



2005640

BIO coffee set 17 parts

Invitation to the breakfast! For roleplay or proper food and drinks. Dishwashersafe, in gift box. From 2+ years.

2005600

BIO dinner set parts

Early practice! A cookset that appeals to girls and boys with bright, soft colors. Cooking together and eating together promotes interaction and social skills. Everyone joins in - in different roles: preparing, cooking, setting a table, serving - Bon Appétit! Packed in gift box (recycled material). From 2+ years.

2005620

BIO Truck

The truck can be loaded heavily and off you go to the construction site for unloading, for this is the loading area can be tilted very easily. Plastic tires (not gummed), packed in gift box (recycled material). From 2+ years.

2005630 **BIO Tractor**

The tractor in bright, fresh colours is a real eye-catcher. The tractor has a movable shovel as front lift, with which a lot of sand or other materials can be transported. Packed in gift box (recycled material). From 2+ years.

2005626

BIO train set

The little train stimulates children's imagination and drives and rolls through many imaginary situations. Packed in gift box (recycled material). From 2+ years.

2005627

BIO construction vehicle set

Excavator and truck are in action on every construction site. Packed in gift box (recycled material). From 2+ years.

2006967 **BIO Sand Set 50 tlg.**

Here you will find something for everyone! Shovels, buckets, sieves and much more promote the versatile, common playing in the group. Fresh, bright colours set the tone and provide new incentives. Packed in gift box (recycled material). From 2+ years.



NEU

NEU

2+

BIO coffee set

KIGA Qualität

BIO dinner set 2+

L 29,5 cm
H 15 cm
2+

BIO Truck

KIGA Qualität

2+

BIO Tractor

L 30 cm
H 16,5 cm

- bio-plastic made of 90% sugar cane
- food safe
- microwaveable
- dishwashersafe
- freezeproof
- contains no poisonous substances
- quality for many years
- 100% recyclable

2+

BIO train set

L 17 cm
H 12 cm

2+

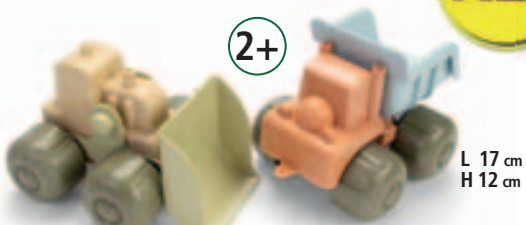

BIO Bconstruction vehicle set

BIO sand set 50 parts

KIGA Qualität

2+

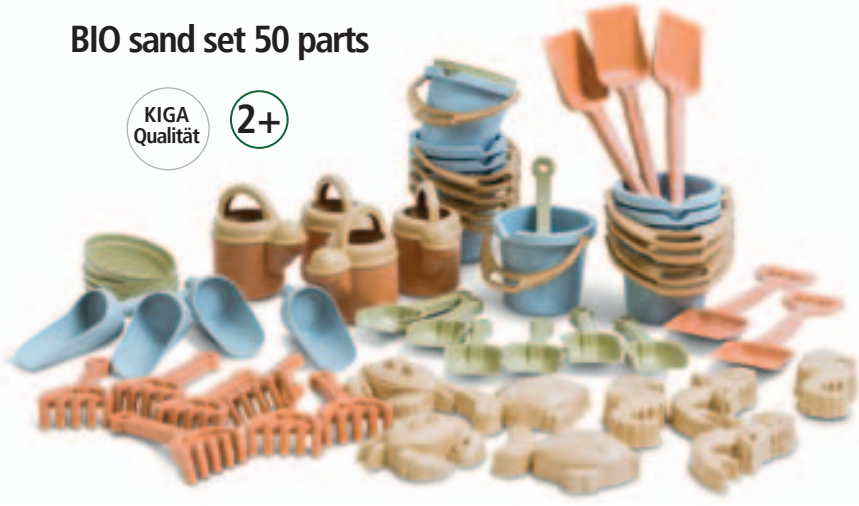



2+

L 24 cm

2001120 Sandshovel



2+

L 25 cm

2001130 Sandshovel



2+

L 24 cm

2001131 Scoop shovel



2+

KIGA Qualität

L: 23 cm

2001132 Scoop super shovel



2+

KIGA Qualität

L 40 cm

2001153 Shovel



2+

KIGA Qualität

L 55 cm

2001154 Shovel

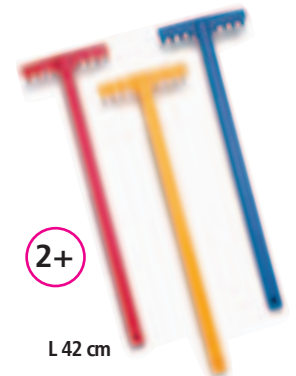

2+

L 42 cm

2001170 Rake



2+

L 58 cm

2001152 Big shovel

KIGA Qualität 2+

2006948 4 large Sand moulds with 2 shovels

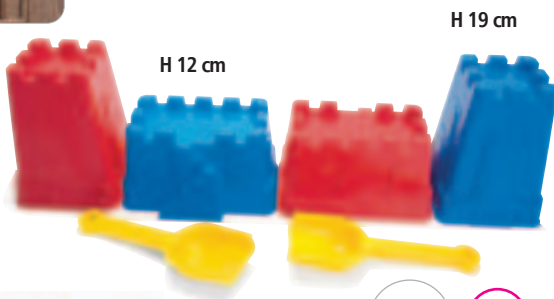

H 12 cm

H 19 cm

KIGA Qualität

2+



L 17 cm

2001243 Sand moulds seaside set of 4, net packaging

KIGA Qualität

2+



L 10-12 cm

2001245 Sand moulds

All dantoy products are durable and have outstanding play value. Made from top grade row materials, they ensure a consistency of quality as well as color. The entire line conforms to EN71 and carries CE-marks accordingly. Red circle symbols give information of age group.

2001120 Sandshovel
Length: 24 cm

2001130 Sandshovel
Length: 25 cm

2001131 Scoop shovel
Length: 24 cm

2001132 Scoop super shovel
Kindergartenquality, length: 23 cm

2001153 Shovel
Kindergartenquality, length: 40 cm

2001154 Shovel
Kindergartenquality, length: 55 cm

2001170 Rake
Length: 42 cm

2001152 Big shovel
Length: 58 cm

2006948
4 Large Sand moulds with 2 shovels
2 walls, 2 castles and 2 shovels
Product L.H.W/cm : 29 x 17 x 21
weight of set: 687 g.

2001243
Sand moulds seaside
Set of 4, packed in net
Product L.H.W/cm : 18 x 4.5 x 14, weight of set 156 g.

2001245 Sand moulds, blended
Length: 10 -12 cm, delivery by stocks

2006966
Giant Sand mould Set
Kindergartenquality, 48 pcs., brown box



KIGA Qualität

2006966 Giant Sand mould Set 48 pcs.

2+

2001560 Sieve, with handles Ø 18 cm
 Kindergartenquality,
 for bucket 2001330 and bucket 2001335



2001560 Sieve Ø 18 cm

KIGA
Qualität

2+

2001330 Bucket, with lip
 Kindergartenquality, height: 16 cm



H 16 cm
 2001330 Bucket, with lip

2+

KIGA
Qualität

2001340 Bucket de luxe
 Kindergartenquality, height: 18 cm

2001314 Bucket, clear
 Height: 14 cm
 Perfect for play and learning in nature. Insects or other small things may easily be observed through the transparent bucket. The bucket is very solid and has a measuring scale and pouring spout. It contains 1 litre.



H 18 cm
 2001340 Bucket de luxe

2+

KIGA
Qualität

2005417 Building Cups
 9 cups in bright, cheerful colors to stack into each other and on top of each other. Four-colored in net, from 2 years up.

2001335 Bucket, with lip
 Height: 16 cm

2001630 Sand/water wheel 30cm
 Height: 30 cm

2001730 Watering can, round
 Height: 21 cm

2001610 Sand/water wheel 27cm
 Height: 27 cm

1+

2005417
 Buildingcups

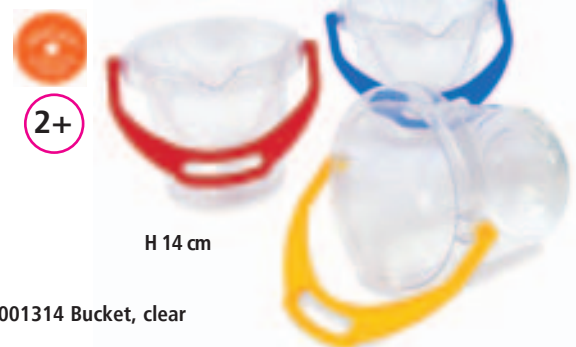

2001314 Bucket, clear

2+

H 14 cm



H 16 cm

2001335 Bucket, with lip

2+



2001630 Sand/water wheel

2+

H 30 cm



H 21 cm

2001730 Watering can round

2+



2001610 Sand/water wheel

2+

H 27 cm

1+



Seesaw Frog



Seesaw Ladybird



Seesaw Bee



Seesaw Dantoy

A nice red ladybird, a funny green frog and a friendly bee invite little children to see-saw. Already children from 1 year up can sit on this cutie seesaws. Length 71 cm, width 37 cm, height 22 cm (floor to seat) holds 50 kg.

2006733 Seesaw Ladybird

2006731 Seesaw Frog

2006732 Seesaw Bee 2006962

2007051 Thorbjorn 56 pcs.

Thorbjorn Frosty Desserts preschool set with countless combination options. The set includes two copies of the exciting book about Thorbjorn and the lost ice crystal. The book's magical universe can be transferred to the set, as it contains two ice crystals and suggestions for the hide-and-seek game "the ice is melting". A giant set with lots of playing value, stimulating children's fine motor skills, sense of balance, imagination and interaction with other children and adults. Packed in cardboard.

2006740 Pan sledge

51 cm x 4 cm x 34 cm

2006785 Snow Shovel Set of 2

Hooray, it has snowed! With these colourful shovels children can push, clear and shovel snow. Colours: green and orange, stable aluminium tube, length 58,5 cm, width 20,5 cm, weight 209 g.

2+



Giant Blocks

Giant Blocks in proven Dantoy-Quality, made of safe and harmless material (free of PVC and aus sicherem, unbedenklichem Material (PVC- und phthalate). With this giant building blocks in two sizes children can build walls, towers, seats and many other constructions in life-size. For indoor and outdoor use, washable and very stable. Kindergartenquality. Available in two colour combinations, each with 26 pcs. in a box: 18 blocks: L: 30 cm, W: 15 cm, H: 15,9 cm, 700 g / 8 blocks: L: 15 cm, W: 15 cm, H: 8,5 cm, 200 g.

2006991 Dantoy Giant Blocks Red 6 Blue

Kindergartenquality, 26 blocks

2006992 Dantoy Giant Blocks yellow & green

Kindergartenquality, 26 blocks



2006740 Pan-sledge



2+

2+

2006785 Snow shovel set of 2



KIGA Qualität

2+

Giant Blocks

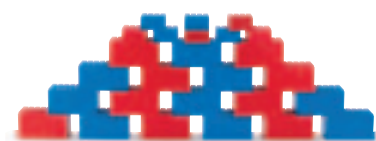
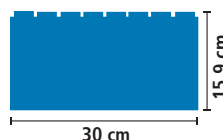

2006991 Giant Blocks red & blue



2006992 Giant Blocks yellow & green

2006962 Sand Set Kindergarten

Complete sand set. Perfect for the institution, allowing many children to play at the same time. Ideal for the sandpit or the beach. Kindergartenquality, 84 pcs, brown box.

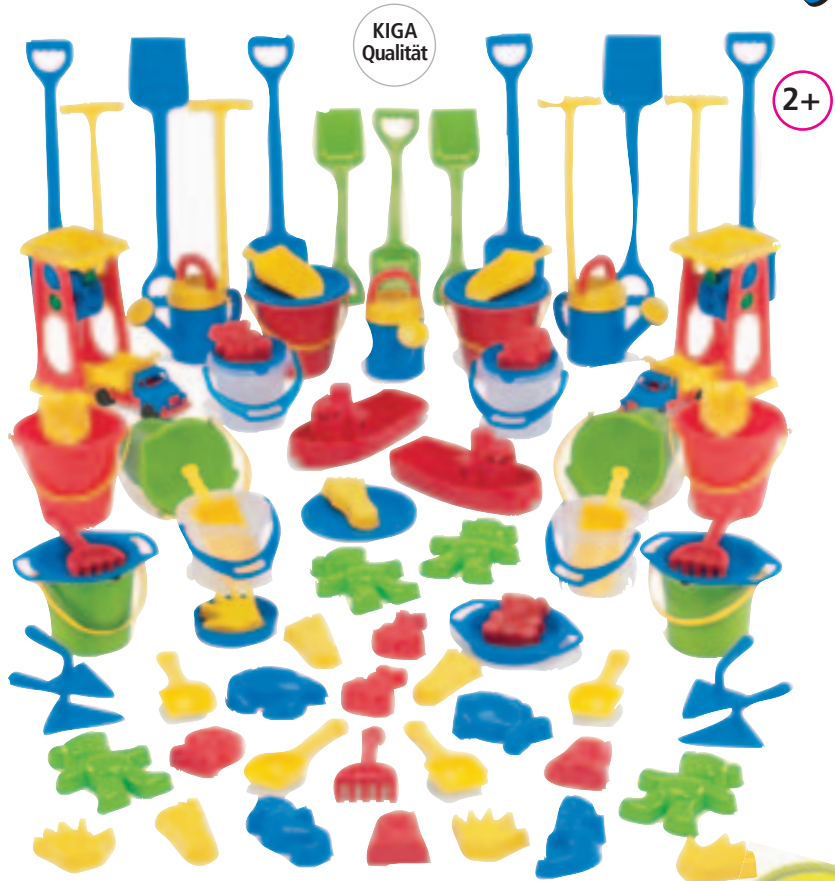
2006962 Sand Set Kindergarten 84 pcs.

2006969 BIO Sand Set with vehicles 62 pcs.

Here you will find something for everyone! Shovels, buckets, sieves and many different vehicles that make playing in the sand even more interesting for a group of children. Made of bioplastics (90% sugar cane, 100% recyclable, 100% sustainable). Packed in cardboard (recycled material).

2006969 BIO Sand Set 62 pcs.

2003117
Pullcart

Kindergartenquality, maximum load: 100 kg, length: 54 cm

2001821
Wheelbarrow, with 2 wheels

Stable wheelbarrow with two tilt-free and silent rubber wheels. May carry up to 50 kg. and is applicable for both indoor and outdoor use. Kindergartenquality, length: 68 cm.

2006923 Stamp abouts

3 Pair Stamp abouts. Height 12 cm, color sorted.



- bio-plastic made of 90% sugar cane
- food safe
- microwaveable
- dishwashersafe
- freezeproof
- contains no poisonous substances
- quality for many years
- 100% recyclable

2006923 Stamp abouts Set of 3

2001821 Wheelbarrow

KIGA Qualität

2+

2003117 Pullcart

KIGA Qualität

2+





L 32 cm

2002137 Bulldozer

2+

KIGA Qualität



2002137 Bulldozer

The hand excavator has a sturdy, round handle so it can ride and dig while playing in the sandbox. When filling and emptying the shovel, the hand-eye coordination of the child is strengthened.

Kindergartenquality, length: 33 cm



L 21 cm

2002215 Tipper truck 21



L 28 cm

2002225 Tipper truck 28

2+

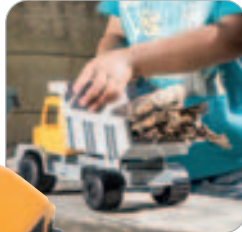

2002215 Tipper truck 21

Classic truck with large cargo area for sand and water. Perfect for playing indoors or outdoors. Length 21 cm.

2002225 Tipper truck 28

Classic truck with large cargo area for sand and water. Perfect for playing indoors or outdoors. Length 28 cm.

2002138 Dumper, big

Kindergartenquality, length: 47 cm

2002135 Tractor, with trailer

With plastic wheels, length: 42 cm, in box

2002119 Tractor, with grab

Kindergartenquality, length: 30 cm

2006933 Auto Service & Car Park

Auto Service with flap gates and parking level. For children between the age of 1 and 5 years, 37 x 13 x 29,5 cm, on box.

2006934 Fun Cars Set of 12

12 funny FunCars with rounded edges, for indoor and outdoor play, length: 9 cm, in box.

KIGA Qualität

2+

with rubber wheels



L: 30 cm

2002119 Tractor, with grab



with plastic wheels

2+

L: 42 cm

2002135 Tractor, with trailer



KIGA Qualität

L: 47 cm

2002138 Dumper, big



2+



2006933 Auto Service & Car Park

1+



1+

2006934 Fun Cars



2002281 Tipper truck, giant

Giant bright coloured truck which may transport up to 50 kg. The large truck bed creates multiple playing possibilities in the sandpit or on the lawn. Kindergartenquality, 84 cm long, 42,5 cm broad, 41 cm high, in box, holds 50 kg.



2002281 Truck Giant

2+

KIGA Qualität

L: 84 cm



2002150 Giant Excavator

Children can sit on the large front loader. The shovel can be controlled, so the hand-eye coordination of the child during loading or unloading of sand is promoted. Kindergartenquality, Length 79 cm, Width 30 cm, Height 40 cm, holds 50 kg.



KIGA Qualität

3+

L: 79 cm

2002150 Riesen Frontlader



2003331 Scooter with rubber wheels

Robust scooter with two additional rear wheels for extra stability. For inside and outside, with trailer hitch and low-noise rubber wheels. Kindergartenqualität, Length 60 cm, Height 37 cm, Width 39 cm, seat height 26 cm.

2003360 ATV - All Terrain Vehicle

Bright Green and extra large balloon wheels make the design of an «All Terrain Vehicle» perfect. Length 63 cm, width 30 cm, height 40 cm, seat height 29 cm. Holds 50 kg.

2003370 Police Racer

Motorcycle with extra wide wheels which avoid any tip over while standing, Kindergartenquality, length 72 cm, height 46 cm, width 38,5 cm, seat height 33 cm, holds 50 kg.

2003333 Police Sooter, with rubber wheels

With two additional rear wheels for extra stability. For inside and outside, with trailer hitch and low-noise rubber wheels. Length 60 cm, width 39cm, height 37 cm, seat-height 26 cm, floor to seat, holds 50 kg.

2003321 Motorcycle, with rubber wheels

The classic for children since 50 years! Durable, sturdy and with two additional rear wheels for extra stability. Strengthens balance, motor skills and self-confidence of the child. For inside and outside, with trailer hitch and low-noise rubber wheels. Kindergartenquality, length 58 cm, height (floor to seat) 26 cm, holds 50 kg.



KIGA Qualität

with rubber wheels

2+

L: 60 cm

2003331 Scooter



2+

KIGA Qualität

L: 63 cm

2003360 ATV - All Terrain Vehicle



L: 72 cm

3+

KIGA Qualität

2003370 Police Racer



L: 60 cm

2003332 Police Scooter



KIGA Qualität

with rubber wheels

2+

L: 58 cm

2003321 Motorcycle



KIGA Qualität



KIGA Qualität

2+



2004382 Tea set in net, 17 pcs.



2004381 Dinner Set, 22 pcs.



2004380 Coffee Set 17 pcs.



2004230 Cutlery Set, 17 pcs.



2006958 Pastry cutters - assorted



2004206 Pot/sieve/pan Set, in net, 7 pcs.



2004220 Baking Set of 12 in net



2004210 Kettle/pot/pan Set, in net, 7 pcs.



2004335 Tea set on tray, 18 pcs.

2004382 Tea set in net
Set of 17, net 18 cm

2004381 Dinner set in net
Set of 22, net 18 cm

2004380 Coffee set in net
Set of 17, net 18 cm

2004230 Cutlery set
Set of 17, length of box 18 cm, shrink wrapped

2006958 Pastry cutters - assorted
Fun and colorful cake molds for dough, modeling clay or sand. For creative and educational play both indoor and outdoor. All parts are dishwasher safe. 24 parts, sorted.

2004206 Pot/sieve/pan set in net
Set of 7, net 28 cm

2004210 Kettle/pot/pan set in net
Set of 7, net 28 cm

2004220 Baking set in net
et of 12, net 22 cm

2004335 Tea set on tray
Set of 18, blister pack

all sets
are
dishwasher safe
up to 60 °



Breakfast, lunch, afternoon tea! For role-playing games or real meals - cover the table together, eat together, clean up, rinse. In role play, children interact, develop social skills, communicate and work together.

2006953 BIO Coffee and Dinner Set 79 parts
Made of bioplastics (90% sugar cane).

2006940 Breakfast/dinner set
Kindergartenquality, set of 78, in box

2006945 Dinner and Baking Set 100 Teile
Kindergartenqualität, 100 Teile, in box

2006952 Dinner set for 12 children
Kindergartenquality, set of 82, in box

2006951 Coffee/tea set for 12 children
Kindergartenquality, set of 45, in box

- bio-plastic made of 90% sugar cane
- food safe
- microwaveable
- dishwashersafe
- freezeproof
- contains no poisonous substances
- quality for many years
- 100% recyclable



2006953 Bio Coffee and Dinner Set 79 parts

2+



2006945 Dinner and Baking Set 100 parts

2+

KIGA Qualität



2006940 Breakfast Set, in box, 78 pcs.

KIGA Qualität

3+



2006952 Dinner Set for 12 children, 82 pcs.

2+

KIGA Qualität



2006951 Coffee/tea Set for 12 children, 45 pcs.

KIGA Qualität

2+



Shovel

There is currently a growing trend for outdoor gardening activities in schools. Interacting with living plants provides a very rich, hands-on learning experience.

First Tools offers a great range of garden tools specially designed for the education sector.

These products have been developed to replicate the design and quality in adult tools in the appropriate size for children aged 3+.

3020010

First Tools Broom

Ideal for keeping the outside area clean this long bristle broom makes tidying up the garden so much fun. Height 90 cm.

3020009

First Tools Fork

This digging fork makes loosening, lifting and turning over soil easier with its light weight but durable -design. Well suited for use in tighter space. Height 78 cm.

3020005

First Tools Shovel

This hard wearing shovel is great for moving soil. Height 75 cm.

3020008

First Tools Spade

This solid, hard wearing spade can be used for general cultivation and breaking up earth. Height 69 cm.

3020007

First Tools Soil Rake

This light weight rake is an essential part of a young gardeners tool kit. Designed to cultivate the soil's surfaces it is ideal for creating a fine seedbed and for cleaning stones. The soil rake has a painted metal head and shaft. Height 96 cm.

3020006

First Tools Leaf Rake

Ideal for clearing all those garden leaves. Height 115 cm.



Broom



Fork



Spade



Soil Rake



Leaf Rake

3020012
First Tools Wheelbarrow

Wheelbarrow in blue-yellow design and improved technical execution. Both handlebars are connected at the level of the wheelbarrow tub with a rigid metal bar, which provides additional stability and safety. Thick-walled tube frame, self-locking screws with red caps, length 110 cm, height 41 cm, tub width 41 cm, from 3 years.



Wheelbarrow



3020030
First Tools Hand Tools Set (3 pcs)

The hand tools set, consisting of a hand rake, hand fork and hand trowel, is ideal for use in a school garden. The durable metal heads and comfortable contoured handles make them ideal for small hands.

3020032
First Tools Tidy Garden Set (4 pcs)

An essential part of every school garden and popular items amongst young gardeners. The Tidy Garden set includes leaf rake, broom, soil rake and shovel.

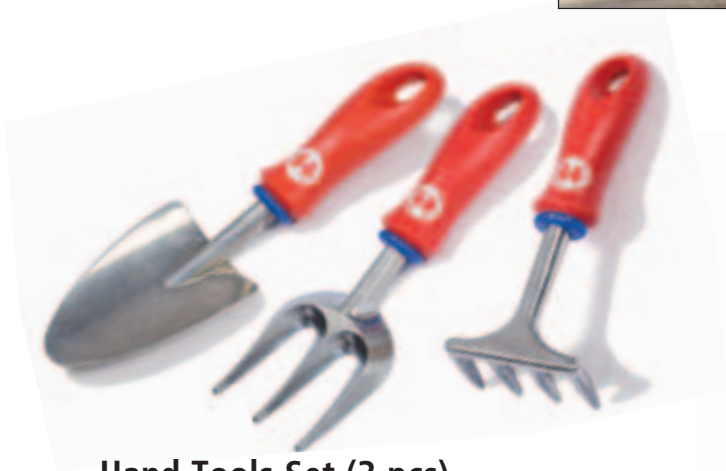

Hand Tools Set (3 pcs)



Tidy Garden Set (4 pcs)





2007040

Green Garden Set 18t pcs.

The new garden set contains all the classic tools and accessories children need for gardening: 1 wheelbarrow, 3 large rakes, 3 large spades, 3 flour shovels, 2 watering cans and 6 small flower pots - all in authentic and natural colours. Packed in cardboard.

First Tools Garden Bed in two sizes

The raised Garden Beds are made from four key components. The kit comes with a Raised Garden bed, Garden Bed Liner, a canopy and an insect netting. The use of the raised garden bed, means you can use specialized soils depending on what you wish to grow. The garden bed liner means you can use the product on hard surfaces in school playing grounds. The canopies will protect young plants from heavy rain, frost and direct sunlight and encourage growth. Since the product is made from plastic it will not decay. It is easy to assemble, no tools required. Children develop a fuller understanding of the world around them when they regularly garden and are therefore better able to engage in the learning process. Helps Children to develop practical skills, coordination, teamwork, planning and improves physical activity. For children aged 5+.

3020020

First Tools Garden Bed 75 x 75 x 28 cm

3020021

First Tools Garden Bed 150 x 75 x 28 cm

2+

KIGA Qualität



2007040 Green Garden Set 18pcs.



Garden Bed in 2 sizes



Sandpit Toys

Shape-retaining, durable sandpit toys of high-class, flexible best quality, made in Germany. The 2 liter buckets are available in red, green or blue always with a yellow handle. Strong, hardwearing scoops in matching colors and a sieve in yellow complete our sandpit toys.

- 1011301 Bucket 2 liter blue
- 1011302 Bucket 2 liter green
- 1011303 Bucket 2 liter red

- 1011306 Scoop blue
- 1011307 Scoop green
- 1011308 Scoop red

- 1011309 Sieve yellow

Sandpit Toys



Buckets



Scoops

Sieve

Willow Cabins

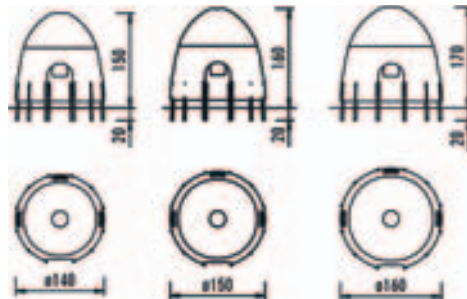
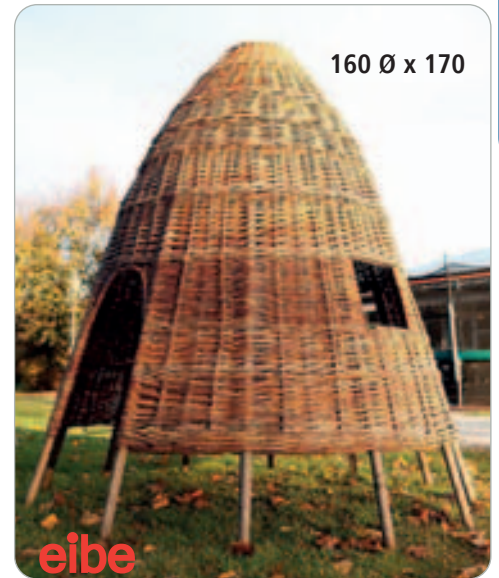

Willow Cabins (TÜV/GS-approval sign)

Unpeeled, braided willow. The included robinia-staffs can be carved in at their end-parts (approx length 30cm). With round-arch-entry, 3 window cutouts all around and a roof ridge opening. Willow Cabins are playable immediately. They enliven all outdoor activities in a natural way: As a house, retreat, source of shade, for painting, splashing and building with clay

or to be vegetated with creeping plants. (Willow products should be treated with wood preservation for a longer lasting lifespan).

Available in 3 different sizes or as a set:

6080260
Willow Cabin Set of 3

6080000
Willow Cabin 140cm diameter • 150 cm hoch

6080010
Willow Cabin 150cm diameter • 160 cm hoch

6080020
Willow Cabin 160cm diameter • 170 cm hoch



tretford INTERLAND

Tretford quality carpet is manufactured with 80% cashmere goat hair and 20% new wool. With this natural materials and its cut resistance into all directions tretford interland is perfect for areas, in which children have intensive floor-contact (playground, kid's corner).

- 80% cashmere goat hair, 20% new wool
- ideal as play mat and area rug
- with natural materials
- environmentally friendly
- durable and easy-care
- improves room climate
- effectively reduces fine dust in indoor air
- reduces noise and echo
- frayproof (won't unravel or fray)
- suitable for underfloor heating
- total height continuous carpeting 5 mm, carpet tile 8 mm

8035xxx

tretford INTERLAND - continuous carpeting, length 2m

The continuous carpeting Interland is a timeless quality carpet which appreciate renewable materials, beautiful colours, comfort and quality. Any desired cutting to the length is possible. Carpet backing: Jute. 40 standard colours and 9 special colours.

8036xxx

tretford EVER - continuous carpeting, length 2m

Manufactured exclusively of natural materials, EVER comes without mothproofing treatment. Sealing bed made of natural rubber, backing Jute. Should definitely be glued to the sub-floor with a suitable ecological carpet glue. 40 standard- colours.

8032xxx

tretford INTERLAND Carpet tile 50 x 50 cm

Installed without adhesives, these tiles are easily removed again and offers wonderful opportunities to create patterns and interesting colour combinations. Fleece backings, total height 8 mm, 40 standard- colours plus special colours.

tretford INTERLIFE

tretford Interlife (ersetzt Plus 7) has been designed especially for highly strained areas and is suited optimal for offices, common/waiting rooms, hotels, shop-fitting and further areas with extensive demands.

- carpet file 70% cashmere goat hair, 30% polyamid
- backing continuous carpeting: jute
- cbacking tile and plank: leece
- hard-wearing, easy care and long lasting
- suitable for use with castors for full-surface adhesion
- reduces noise and echo
- improves room climate
- effectively reduces fine dust in indoor air
- total height 5 mm

8037xxx

tretford INTERLIFE - Continuous carpeting, length 2m

Hard-wearing, easy care and very versatile carpet for commercial use, 40 standard- colours.

8031xxx

tretford INTERLIFE - Carpet tile 50 x 50 cm

This self-laying carpet tile for heavy traffic areas in commercial and iving areas offers many possibilities in terms of pattern and colour combinations. Backing: fleece, 40 standard- colours.

8034xxx

tretford INTERLIFE - Plank 25 x 100 cm

Tretford carpet planks for heavy traffic areas in commercial and iving areas offer numerous design options. With the size 25 x 100 cm new laying patterns and special highlights can be created. Backing: fleece, 40 standard- colours.

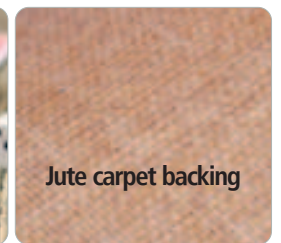
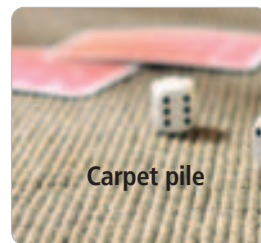

tretford Round Carpets with overlock

All-around usable carpets made of Interland broadloom (80% goat Hair und 20% wool) with colour matching overlock. Thanks to the natural pile material they are warm, soothing and hardwearing. Available in 40 standard colours and 9 special colours.

From 1,60 m up to 4 m diameter (customized sizes in 10s raster). All intermediate dimensions in 10s raster are always calculated as the final size.

- 80% cashmere goat hair, 20% new wool
- with natural materials
- ideal as play mat and area rug
- environmentally friendly
- durable and easy-care
- improves room climate
- effectively reduces fine dust in indoor air
- reduces noise and echo

- 8020xxx Round Carpet from 1,60 m to 2 m diameter
- 8021xxx Round Carpet from 2,10 m to 2,50 m diameter
- 8022xxx Round Carpet from 2,60 m to 3 m diameter
- 8023xxx Round Carpet from 3,10 m to 3,50 m diameter
- 8024xxx Round Carpet from 3,60 m to 4 m diameter

tretford rectangular carpets with overlock

All-around usable, adapted carpets made of Interland broadloom (80% Goat Hair und 20% wool), with colour matching overlock. Individually desired dimensions in three screened widths, up to 2,0 m, 3,0 m and 4,0 m and individual legths up to 6,0 m respectively 4,0 m are available. The carpets feature the same quality characteristics as Interland broadloom. Available in 40 standard colours and 9 special colours.

- 80% cashmere goat hair, 20% new wool
- with natural materials
- ideal as play mat and area rug
- environmentally friendly
- durable and easy-care
- improves room climate
- effectively reduces fine dust in indoor air
- reduces noise and echo

Width (= direction of ribs) up to 2,0 m, Interland-Quality with backing jute. When placing order please indicate desired width and length as well as colour code (page 191).

- 8040215 - Length up to 1,50 m
- 8040220 - Length up to 2,0 m
- 8040225 - Length up to 2,50 m
- 8040230 - Length up to 3,0 m
- 8040235 - Length up to 3,50 m
- 8040240 - Length up to 4,0 m
- 8040245 - Length up to 4,50 m
- 8040250 - Length up to 5,0 m
- 8040255 - Length up to 5,50 m
- 8040260 - Length up to 6,0 m

Width (= direction of ribs) 2,01 m to 3,0 m, Interland-Quality with backing fleece. When placing order please indicate desired width and length as well as colour code (page 191).

- 8040325 - Length up to 2,50 m
- 8040330 - Length up to 3,0 m
- 8040335 - Length up to 3,50 m
- 8040340 - Length up to 4,0 m

Width (= direction of ribs) 3,01 to 4,0 m, Interland-Quality with backing fleece. When placing order please indicate desired width and length as well as colour code (page 191).

- 8040425 - Length up to 2,50 m
- 8040430 - Length up to 3,0 m
- 8040435 - Length up to 3,50 m
- 8040440 - Length up to 4,0 m

Carpets with overlock up to 1.0 m wide are listed in the price list under "Läufer" (carpet runner).

Round carpets with overlock up to 1.0 m Diameter are listed in the price list.

Info: Round and rectangular carpets are made from 2 m wide Interland-meter product. Carpets up to 2 m have the classical backing jute. Carpets over 2 m - made of two pieces - have a seam in the center and additionally a second textile backing (fleece). For carpet laying non-slip surface is recommended.

Round Carpets with Overlock

- individual dimensions



tretford rectangular Carpets with Overlock

- individual dimensions

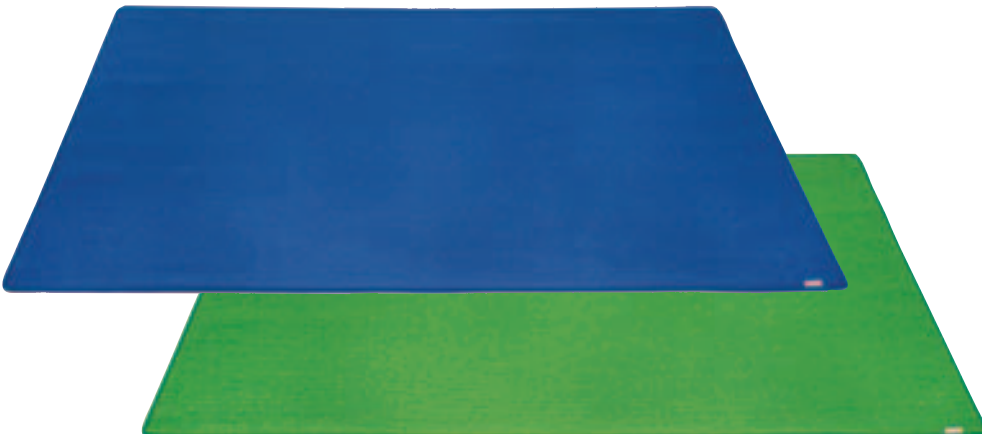

• further pictures next page



**tretford
Round Seat Pads**

8030999

tretford Round Seat Pads Set of 10

Colourful, round seat pads, perfectly suitable for play and discussions groups or morning rounds. With their specific size the pads can be used for active games or for example as small play islands. The seat pads can be placed on every surface. The underside is covered with felt in light grey which gives additional insulation and stabilization. Made in well known tretford quality avoiding fraying. 10 round seat pads, colours are subjects to availability, Ø 40 cm.

8030990

Furniture glides tretford set of 12

The functional, round furniture glides in proven tretford-quality protect furniture and floor. Quick and easily adjustable under the legs of furniture with the self adhesive backing. Diameter 24 mm, colour brown, set of 12.



**Furniture glides tretford
12 pcs.**



Set of 10

- Tretford Carpets
- round or rectangular
- overlapped
- individually dimensions
(see previous page)



- tretford INTERLAND products • tretford INTERLIFE products
- tretford Rectangular and Round Carpets • each product available in 40 Standard Colours:
- Please replace XXX with the according tretford colour code on orders!



568
Mais

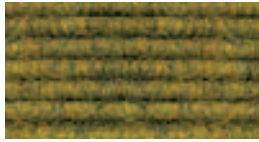

560
Curry



564
Bernstein



591
Lachs



588
Rosa



559
Terracotta

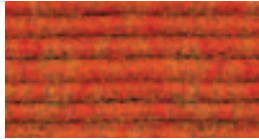

585
Orange



582
Grapefruit



570
Erdbeere



524
Kirsche



633
Granat



581
Brombeer



584
Pflaume



592
Lila



520
Eisen



575
Mitternacht



567
Pazifik



514
Jeans



516
Kornblume



517
Riviera



558
Opal



565
Tanne



566
Klee



569
Moos



580
Apfel



519
Salbei



556
Farn



590
Mocca



573
Tabak



572
Nougat



532
Sisal



555
Gobi



571
Sahara



601
Treibholz



515
Quarz



538
Aluminium



523
Zink

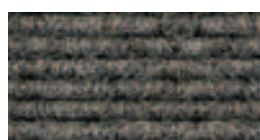

512
Schiefer



534
Anthrazit

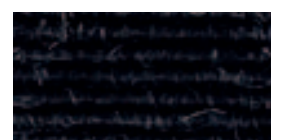

632
graphit

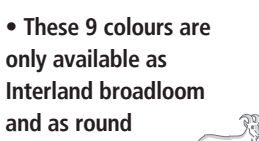

• These 9 colours are only available as Interland broadloom and as round and rectangle carpets.

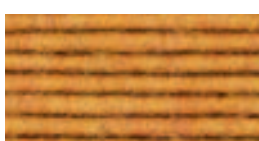

603
Sonnenblume



645
Flamingo



644
Aubergine



641
Arktis



643
Tundra



622
Wasabi

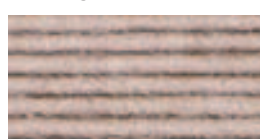

647
Perle

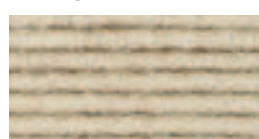

611
Birne



640
Eis

PÄNZ Sitting Cube



PÄNZ Kids Sitting Cube

The KIDS play- and sitting cubes can be used to play with, to sit on - reading or listening. They can easily be moved from one point to the other and thus make mobile sitting-circles or play-zones possible. The flexible but strong, heavy-duty cubes can be used variedly in gymnastics, too.

Key-idea: body perception, training of motion, creative play, psychomotor skills, adroitness, sense of touch and balance, useful as positioning-aid and support to sit in therapy and rehabilitation.

Cube, base 45 x 45 cm, 50 cm high. Stable, but still relatively light body of non-toxic, shape-retaining foam, coated with high quality fabric, skin-pleasant, hard-wearing and easy to clean. Available in 4 beautiful, clear colors, the bottom made of non-skid, ribbed gym-mat material in blue.

1010550

PÄNZ Kids Sitting Cube yellow

1010551

PÄNZ Kids Sitting Cube red

1010552

PÄNZ Kids Sitting Cube green

1010553

PÄNZ Kids Sitting Cube blue

3051003

Foam Sitting Cubes small 30 x 30 cm, set of 4

Each cubes has a durable bottom made from gymnastic-mat fabric, sides are made from coloured tarp fabric in blue, red, yellow or green colour. Durable cover material is free of phthalates, foam density 65. Dimensions 30 cm x 30 cm x 30 cm.

PÄNZ Kids Sitting Cube Modern Colours

All 6 sides of these Kids play- and sitting cubes are covered with high quality, non-phthalate fabric. Available in 3 new, modern colours: light blue, light green and pink.

1010549

PÄNZ Kids Sitting Cube light blue

1010556

PÄNZ Kids Sitting Cube light green

1010557

PÄNZ Kids Sitting Cube pink

1010740

Playcarpet City

Playcarpet mapping various city and landscape images for various purposes, children are ensured to play with toy cars, bricks and figures. Single motives inspire to role plays, authentic colours and design suitable for children encourages imaginative play.

Toy cars can be rolled easily and smoothly on high quality carpets. Complies to all relevant safety standards. Carpet size 150 x 80 cm, durable, tufted material, linked edges, 100 % polyamide.

Foam Sitting Cubes small Set of 4



PÄNZ Sitting Cube Modern colours



Playcarpet City



1010545

Colonia Building Kit 20 parts

With these 20 components of the all-purpose building kit lots of various buildings can be built - for playing or construction. Children may design their own gymnastic and play-area landscapes with numerous obstacles and passages for active motion games to enhance motor- and psychomotor skills, creativity and coordination of motion. Suitable for kindergarten, schools, gymnastics, sports, therapy, rehabilitation. Non toxic foam body, coated with PLST-cloth, easy to clean and disinfect.

2 elements rectangular 100 x 25 x 25 cm, blue/blue
 + 4 elements rectangular 50 x 25 x 25 cm, blue/green
 + 4 elements rectangular 25 x 25 x 25 cm, blue/yellow
 + 4 elements wedge-shaped 50 x 55 x 25 cm, blue/blue
 + 2 elements triangular, 50 x 70 x 25 cm, blue/red
 + 4 elements triangular 50 x 35 x 25 cm blue/red

1010547

Soft Mat Kit FORTUNA 21 parts

The 20 components of the building kit COLONIA well fitted in a large soft-mat cover, ca. 200 x 100 cm, with zipper and 4 handles, bottom made of non-skid gym-mat fabric, top of smooth PLST-cloth, long-wearing, easy to clean and disinfect.

This soft-mat cover adds another useful function in gymnastics and for playing and helps to keep things in order, as the kit COLONIA can easily be stored and made available again in the twinkling of an eye.



COLONIA Building Kit

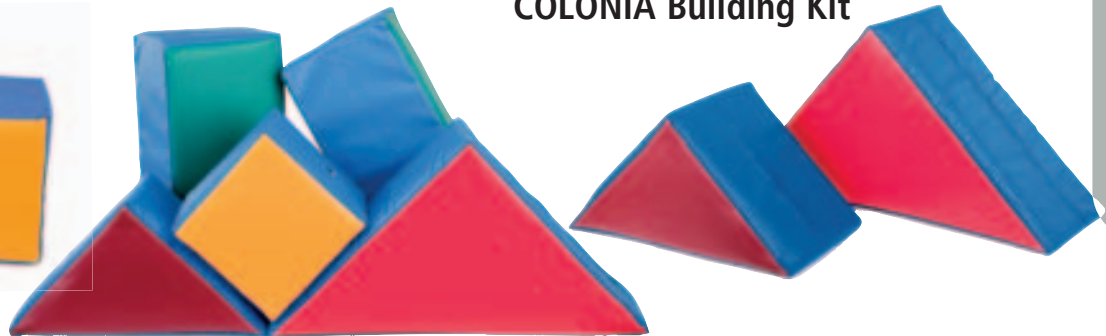

Soft Mat Kit FORTUNA



Gymnastic Mats Colour Combi Leather edges



Gymnastic Mats Colour Combi Standard



Leather edges



Standard



Gymnastic Mat fabric

Gymnastic Mats standard



Soft Gym Mat

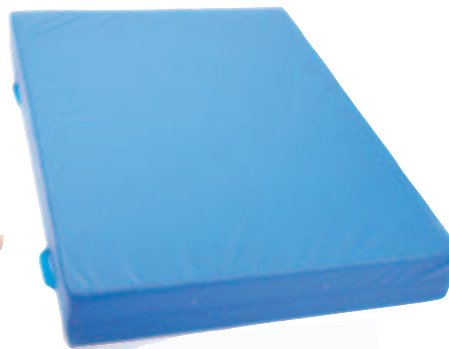

Baby Gymnastic Mats



Baby Gymnastic Mats Colour Combi



Leather edges

Standard



Gymnastic Mats made of Flexible Foam or Composite VB 100 (Made in Germany)

Our standard gymnastic mats are available in the version «upside and bottom side made of blue gymnastic mat fabric» (honeycomb pattern, durable, non-slippery).

A new offer are our gymnastic mats in colour combinations blue/blue, red/blue, green/blue and yellow/blue. The blue bottom side is always covered with blue gymnastic mat fabric (honeycomb pattern, durable, non-slippery), the coloured upperside with smooth mat fabric.

For supplementary equipment the basic version (without leather edges) is optionally available with leather edges and/or carrying straps.

In different sizes and in different material versions like flexible foam or composite VB 100, each one either 6 or 8 cm high.

For all different models and versions with article numbers and prices please ask for separat Jakobs-price list for Gymnastic mats. (Special sizes on request).

1600901 to 1600911

Gymnastic Mats Standard Flexible-Foam RG 35

Gymnastic mats with a core of flexible foam for application and use in the kindergarten-range, 6 or 8 cm high.

1600801 bis 1600804

Gymnastic Mats Colour Combi Flexible-Foam RG 35

Gymnastic mats with a core of flexible foam for application and use in the kindergarten-range, 6 or 8 cm high.

1600919 to 1600943

Gymnastic Mats Standard Composite VB 100

Gymnastic mats with a core of composite fabric for application in school- and leisure sport and all kinds of gymnastic. Height 6cm or 8cm. Please specify requested colour combination when ordering.

1600805bis 1600808

Gymnastic Mats Colour Combi Composite VB 100

Gymnastic mats with a core of composite fabric for application in school- and leisure sport and all kinds of gymnastic. Height 6cm or 8cm. Please specify requested colour combination when ordering.

1700981 to 1700989

Soft Gym Mats RG 20 or RG 23

Soft gym mats guarantee a lot of safety for all jumping exercises. All mats are provided with carrying straps, one side is covered with DIN-athletic mat fabric, the other side with smooth PLST-cloth in blue. For supplementary equipment optional available with leather edges and/or ventilation grid. Also available as fold-away soft gym mat (space-saving storage). In different sizes and requested designs. For article number and prices please see current Jakobs-price list or separat Jakobs price-list for Gymnastic mats.

Baby Gymnastic Mats

(Made in Germany)

These nice, small gymnastic mats in 4 colour combinations blue/blue, red/blue, green/blue and yellow/blue are manufactured in the material version RG 35/40 in Germany. For laying on it, for playing and crawling for babies and very young children in crèche areas, for first sport experience and many other movement-, running- and balance activities.

The blue bottom side is always covered with blue gymnastic mat fabric (honeycomb pattern, durable, non-slippery), the desired coloured upperside with smooth mat fabric.

The basic version (without leather edges) is optionally available with leather edges.

For all different models and versions with article numbers and prices please ask for separat Jakobs-price list for Gymnastic mats. (Special sizes on request).

1600999

Baby Gymnastic Mats Colour Combination Flexible-Foam RG 35

Gymnastic mats with a core of flexible foam for application and use in crèche and play areas, size 75 cm x 50 cm, 6 cm high. Please specify requested colour combination when ordering.

1601999

Baby Gymnastic Mats Colour Combination Flexible-Foam RG 35 with 4 Leather corners

Rollinto Set

The red inner roll suits exactly into the blue outer roll, to be composed of two rolls it is suitable to work therapeutically with older children or even adults. The blue outer roll is open on both ends like a barrel, inside friendly yellow. Both rolls invite a wide range of creative possibilities and combinations for all exercises of balance-training, training of motion and motion control.

1010560 Rollinto Set

Set of outer roll and inner roll, set-weight 12kg. Both rolls are made of softfoam RG 28/70, CFC-free, coated with high durable quality-hood in bright colours, double stitched, skin-pleasant and easy to clean. Maximum load 120 kg under dynamic load.

1010558 Rollinto Outer Roll

A large, high stable roll, length 100 cm, \boxtimes 70cm, wall-thickness 10 cm, weight 7 kg.

1010559 Rollinto Inner Roll

Compact, red roll, length 100 cm, diameter 50cm, weight 5kg.

Playpen Balls/Therapy-Balls

The feathery hollow plastic balls in bright colors (six-colored sorting) guarantee risk-free active playing and a unique tactile experience. One cubic meter is about 6.000 balls with 60mm diameter.

Coloured sorted balls and red/green/blue-transparent balls available in size 60 mm diameter.

1011190 Playpen Balls/Therapy-Balls 60 mm \emptyset
Bag with 500 pcs. coloured sorted balls 60 mm.

1011191 Playpen Balls/Therapy-Balls 60 mm \emptyset , transparent
Bag with 500 pcs. balls 60 mm, red/green/blue-transparent.

Ball-pools two coloured or requested colour

Dimensionally stable ball-pools to be filled with Playpen balls. Children immerse themselves into a very special world of experience and play which always provides body and sensory perception.

4 blocks of CFC-free foam, dimensionally stable, each block is 50cm high, wall-thickness 20cm, covered with a heavy duty outer cover made of tear-proof tarpaulin fabric, double sewed in one piece (walls and floor), easy to clean and to disinfect. The outer cover is to be pulled over the foam blocks and keeps them save and stable together. No risk of injury, for single or group play, for several children depending on children's sizes. (Delivery without balls)

1011100 Ball-pool yellow/green 150 x 150 cm
Ball quantity approx. 2000 – 2500 pcs

1011101 Ball-pool red/blue 150 x150cm
Ball quantity approx. 2000 – 2500 pcs

1011110 Ball-pool yellow/green 200 x 200 cm
Ball quantity approx. 4000-4500 pcs

1011111 Ball-pool red/blue 200 x 200cm
Ball quantity approx. 4000-4500 pcs

1011120 Ball-pool yellow/green 250 x 250cm
Ball quantity approx. 6000-7500 pcs

1011121 Ball-pool red/blue 250 x 250 cm
Ball quantity approx. 6000-7500 pcs



Rollinto Outer Roll



Inner Roll

Rollinto Set



Playpen Balls 6-coloured sorting

transparent



Ball-pool yellow / green



Ball-pool red / blue

various sizes

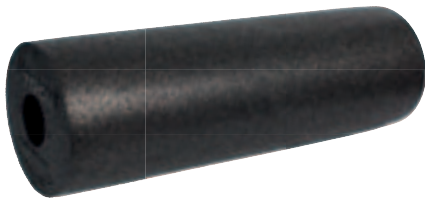

**TOGU®
Blackroll**

TOGU® Blackroll 45

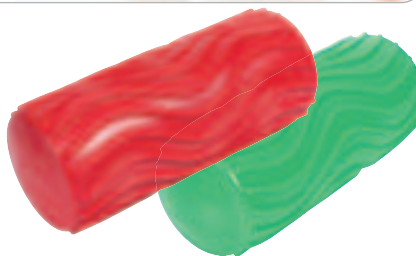
**TOGU® Blackroll
Pro Orange**
Actiroll® Wave

Massage Roller Fit & Healthy

TOGU® Gymnasticball, 300 g

TOGU Blackroll

The TOGU Blackroll - Made in Germany - is the perfect recovery tool for self massage and releasing the Myofascia (connective tissue sheath of muscles and muscle groups):

- Prevention and treatment of myofascial- and muscle problems
- Active regeneration with improved blood circulation
- trigger zone treatment for tension through sports and everyday wear
- Easy self-massage
- Ideal warm-up before and recovery after sport

9400048 TOGU Blackroll

Ca. 30 x 15 cm Ø, black, in a box with instructions.

9410070 TOGU Blackroll 45

Allows more application options and enlarges the surface. Ca. 45 x 15 cm Ø, black, in a box with instructions.

9410210
TOGU Blackroll Pro Orange

The Blackroll Pro foam roller is 50% harder than the Standard Roller, and palpably increases muscular elasticity and performance with little effort and simple exercises. Due to its extreme hardness, however, it should be noted that the PRO is only the right roller for experienced users or those with high pain tolerance. 30 x 15 cm Ø, orange.

9465360 Actiroll Wave

The Actiroll is the first new air-filled and hard regeneration tool for self-massage and myofascial relaxation. The Actiroll can be adjusted easily by using the attached hand pump to different hardness. So Actiroll is perfect to reach new progressions in exercises and to be used by different individuals. The air-filling causes an absorbing effect. Therefore it is also allowed and recommended to roll and move even on joints and vertebral bodies. This roll offers a variety of use in fascia fitness, training and therapy. The material Ruton is hardened, robust and easy to clean, skin friendly, odorless and 100% recyclable. 30 x 11,5 cm Ø, red, green, black, colour sorted, max. load ca. 200kg, with instructions and pump.

1000885
Massage Roller Fit & Healthy

That roller is a regeneration tool for simple massage of muscle fasciae and trigger zones. Structured surface ensure a very profound effect. Usage increases circulation, eases tensions and advances muscular regeneration after burdening. At the same time the roller can be used as a coordination and core training-tool. For use in therapy, training and at home, dimensions approx. 34 cm, Ø 15 cm.

TOGU Gymnasticballs Standard

The value priced quality in gymnastics balls for schools and associations. Very bouncy, good elasticity, anti-static.

9430402 red
9430404 blue
9430412 türkis

9430403 yellow
9430406 green
9430413 purple



Skipping Ropes

Braided after international regulations, length 3m, 5 colors, approx 9mm constantly strong.

- 1300750 Skipping Rope 3m, blue
- 1300752 Skipping Rope 3m, green
- 1300754 Skipping Rope 3m, yellow
- 1300756 Skipping Rope 3m, white
- 1300758 Skipping Rope 3m, red

1300770

Skipping Ropes 3m, set of 10
10 Skipping ropes in a polybag, assorted colors.

1300710 Skipping Rope (hemp), length 280cm

1300715

Swing-Rope (hemp), length 8m
The middle part of the rope is tightened to 12mm, both ends feature loops and hooks.

1300735

Magic String (gym string), length 8m
Flexible braided rubber string, red/white, approx. 8mm strong with plastic hooks on both ends.

1300736

Magic Circle (gym circle), length 20m
Flexible braided rubber string, red/white, approx. 8mm strong with plastic lock, adjustable.

Neon Rope

Skipping Ropes in neon colors and four different lengths according to the colors.

- 1300740 Neon Rope neon yellow - 2,13 m
- 1300743 Neon Rope neon pink - 2,43 m
- 1300746 Neon Rope neon orange - 2,73 m
- 1300749 Neon Rope neon yellow - 3 m

1300730

Balance-Rope, length 2m
Blue balance-rope made of polypropylene, approx. 70mm diameter, length 2m. Perfect practicing-device for balancing and strenghtenig of the leg musculature.

1300720

Pulling Rope, length 10m
Natural colored pulling rope made of sleek polypropylene with red markings and plastic-ends, approx 20mm diameter, length 10m.

Skipping Ropes

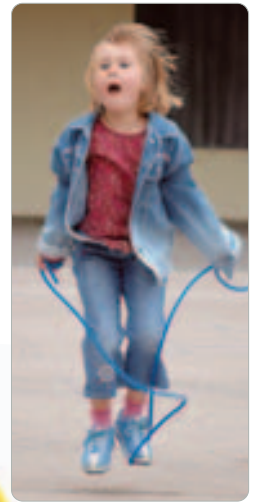

Skipping Ropes Set of 10



Skipping-Rope



Swing-Rope



Magic String



Magic Circle

Neon Ropes



Balance Rope

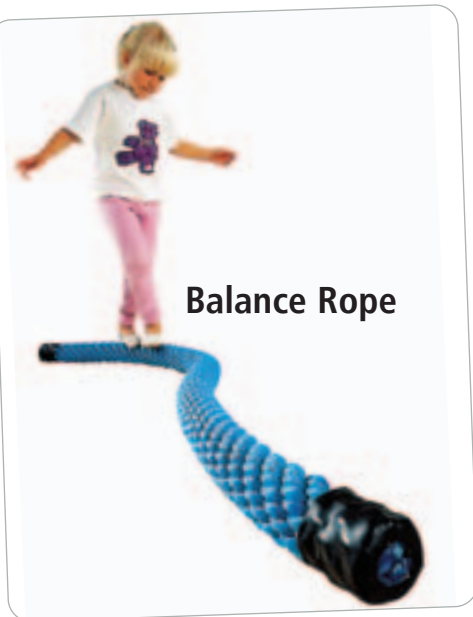

Pulling Rope





Porcupine Massage Balls

Porcupine Massage Balls

The original porcupine massage balls in high quality for purposeful use of tensions, for stimulation and training of reflex zones, for all kinds of moving-, gripping- and massage-exercises. For advancement of blood circulation, for stabilisation of connective tissue and musculature, for stress reduction. In four different, color-specific sizes. Max. load 10 kg, not suitable for fascial training. (Important note: This product is not a toy! This product is a fitness- and wellness article, contains phthalates)

- 1000895 Porcupine Massage Ball orange 63mm Ø
- 1000896 Porcupine Massage Ball yellow 78mm Ø
- 1000897 Porcupine Massage Ball red 92mm Ø
- 1000898 Porcupine Massage Ball blue 100mm Ø

Molten Softballs

Qualityballs made of foam with washable elephant skin, soft and grippy. In 3 sizes.

- 4352360 Soft-HR
16 cm Ø, 100 g, red
- 4352361 Soft-SB
18 cm Ø, 130 g, blue
- 4352362 Soft-VW
21 cm Ø, 200 g, white

4008093 Gym Ring, Set of 4 pcs.

18 cm Ø red, yellow, blue, green, colour sorted.

Bean Bags

Bags filled with beans for many parcours- and balance-games, dexterity- and classification-games. Size 17 x 12,5cm.

- 1000840 Bean Bag blue
- 1000841 Bean Bag yellow
- 1000842 Bean Bag green
- 1000843 Bean Bag red

1000889 Moss-rubber Throwing-balls, set of 12

12 moss-rubber balls, 6cm diameter, assorted colors. Colors may vary.

4280301 Ball carrier-staffs, set of 6

6 staffs (beech), 22cm

4280309 Wooden gym club, 40cm

Molten Softballs with Elephant skin



Gym rings



Bean Bags

Moos rubberballs

Ball carrying bar



Wooden gym club



Rythm bands for kindergarten, school, sports and gymnastics

The rythm bands made of Rayon-silk with woven edges do beautifully swing, are very muted and, in this version, aedequate for professional use in clubs, dancing- and gym-schools. Plastic staff with ring- and rotation-curl for hangig up and out. For the separate areas, seven lengths are available, each in a set of 5 in the 5 colors red, blue, yellow, orange and green.

- 1019101 Rythm bands pro, 100cm (set of 5)
- 1019102 Rythm bands pro, 150cm (set of 5)
- 1019103 Rythm bands pro, 200cm (set of 5)
- 1019104 Rythm bands pro, 250cm (set of 5)
- 1019105 Rythm bands pro, 300cm (set of 5)
- 1019106 Rythm bands pro, 400cm (set of 5)
- 1019107 Rythm bands pro, 500cm (set of 5)

Gymnastics accessoires

Classic, high-quality wooden gym devices for all areas of gym and sports.

- 1000700 Wooden gym hoop, 60cm diameter
- 1000701 Wooden gym hoop, 70cm diameter
- 1000702 Wooden gym hoop, 80cm diameter

4280419

Pine Wood Sports Staff, naturally lacquered
Length 80cm, 24mm diameter

4280420

Pine Wood Sports Staff, naturally lacquered
Length 100cm, 24mm diameter

1400815

Wooden Hemisphere, beech, oiled
Balance-hemisphere made of oiled solid beech, slipproof due to its moss-rubber-cover, height 8cm, 14cm diameter, for in- and outdoors, 1 pc.

Rythm bands



Wooden gym hoops

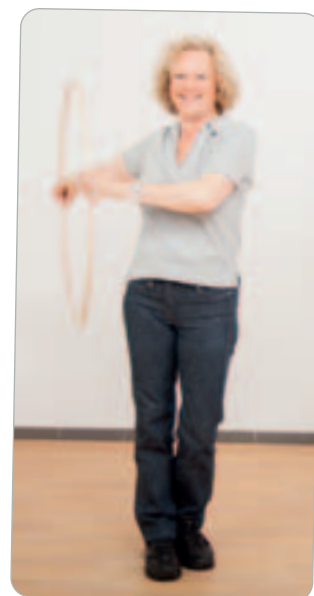
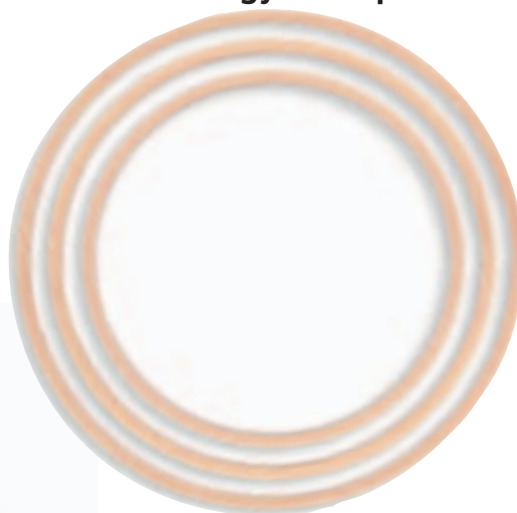

Pine Wood Sports Staff



Wooden Hemisphere

HOVOBOARD®



Hovoboard® is a standing board for active standing and motion requirement at the workplace. Elegant, shapely design in combination with innovative function provide movement for everyone - everywhere.



HOVOBOARD is a standing board for active standing and movement at the workplace. Elegant, shapely design in combination with innovative function provide movement for everyone - everywhere. Two interchangeable base plates - Hovobase 1 and Hovobase 2 - set different movement requirements for unrestricted work (Level 1) or for active balancing (Level 2). Each base can be used quickly, easily, durable and stable via integrated magnets. Made in Germany from high quality material components.

- Movement for every workplace or conference room, meetings etc.
- From the height-adjustable desk to the conference room or at work at home
- A change in the movement that is physical, emotional and intellectually has a positive effect
- Optimal combination of design, functionality and benefits
- More active movement during the working day, regardless of the environment
- Heart rate becomes measurable compared to sedentary activity increased
- The human body is designed to be three-dimensional move, with the Hovoboard is easily in any environment possible
- Using the Hovoboard supports the active one calorie burning

• **Level 1** requires gentle, light movements, the one Allow unrestricted working with your hands at the desk

• **Level 2** requires active balancing and can be used during break time or in between to promote dynamic movement activity. So can concentration and receptiveness improved and / or intellectual processes, tasks and workflows are positively supported

• Focus on movement areas:
Dorsiflexion = foot towards the back of the foot - toes move up, heel down
Plantar flexion = foot towards the sole of the foot - heel up, toes down
Dynamic stabilization of the spine.

1013450
Hovoboard "Classic Edition"

1013451
Hovoboard "Art Edition"

1013452
Hovoboard "Black Edition"



Hovoboard
„Classic Edition“
Art.-Nr. 1013450



Hovoboard
„Art Edition“
Art.-Nr. 1013451



Hovoboard
„Black Edition“
Art.-Nr. 1013452

Standing board & balance board

Two exchangeable base plates - Hovobase 1 and Hovobase 2 -
 Make different motion requirements for unrestricted Work (level 1)
 or for active balancing (Level 2).

Each base can be quickly, easily, firmly and stably
 inserted and exchanged using intergrated magnets.



**Hovobase
Level 1**



**Hovobase
Level 2**

VIDEO

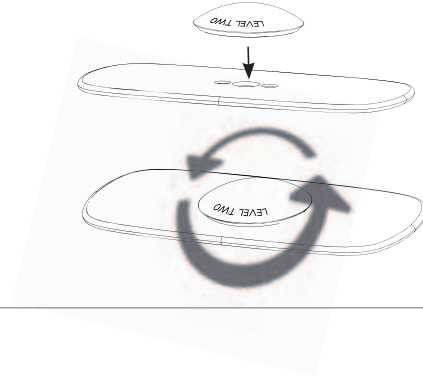

Hovoboard specifications:

- Board made of birch plywood, stained and varnished
- Dimensions: L 293 mm x W 612 mm x H 15 mm
- Weight: Board individually about 0,5kg / board with base about 1,5kg
- Load capacity: The Hovoboard can be loaded up to a maximum of 100kg
- T read covered with non-slip, thermoplastic elastomer (TPE)
- Base plates - Hovobase 1 and 2 - for easy Replacement, each 50 x 100 mm, polyamide body PA 6 GF 30, bearing surface made of anti-slip material TPU
- Board height including base: 60 mm

Delivery:

- 1 * Hovoboard
- 2 * Hovobase (Level 1 and Level 2)
- 1 * carrying bag (70 * 50cm)



Slot and magnets for Hovobase



Original GymTop® Therapy

Original GymTop Therapy Top and GymTop Contura Therapy Top

Therapy tops made of high quality molded plastic, produced in blow-technique, tread surface or contoured surface for secure hold, color red, for persons up to 120 kg, detailed instructions in four languages. On request delivery in deco-box. 40 cm \square , height 9 cm.

1010600
Original GymTop Therapy Top in decoration box

The GymTop is the ideal training-device to improve sense of balance, coordination and reaction with a great variety of exercises.

1010597 Original GymTop Therapy Top in deco box
1010602
Original GymTop Contura Therapy Top

Lots of knobs are arranged uniformly on the surface, thus enhance comfortable stimulation and intensive and sensoric impulsion.

1010598 Original GymTop Contura Therapy Top in deco box
1014600
GymTop Multiplex

Very strong, dimensionally stable wooden top made of birch multiplex with a slip resistant, insensitive screen printing surface. This wooden top in excellent materials and workmanship is a high quality option for professional use for the improvement of balance, coordination and musclefunction. Measures: diameter approx. 40 cm, height approx. 8 cm, weight 3,8 kg.

GymTop® Contura® Therapy Top

GymTop® Multiplex

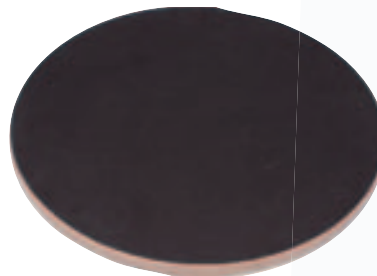
GymTop® Multiplex

1010605

TheraBeans

Training with TheraBeans is a method of high effectiveness for the whole muscular system of foot and lower leg, hand and forearm, its application is as easy as efficient. The specific part of the muscles is trained by a simple sequence of exercises without any risk of strain. Three components: The mechanical friction of the shifting beans, the two sizes tuned on each other and the smooth, rounded surface generate a resistance of almost neutral direction, i.e. during exercising there is hardly any phase of relief. Due to the comprehensive sensoric response TheraBeans are also well appropriate to be employed in the field of psychomotor and tactile perception. Hiding and searching pieces of a puzzle, marbles or other small objects between TheraBeans is fun. There are other games encouraging visual perception and fine motor skills as well, e.g. recreating patterns with TheraBeans, «goal flipping» or finding TheraBeans hid in modeling clay.

- Synthetic beans of polypropylene
- Produced in Germany
- Mixture of 2 different sizes 20 x 15 mm and 13 x 9 mm, each size in both colors blue and gray,
- Non toxic (food-standard), hygienically perfect, washable, suitable for disinfection
- Packed in units of 5 kg in polybag (corresponds to 8,33 liter) - 600 g ~ 1 liter
- Inclusive instructions with illustrative colored poster

Indications: muscle training, rehabilitation of muscle weakness, relaxation, stimulating blood circulation and lymphatic flow, improving metabolism, massage, exercises for sensorimotoric

Field of application: Therapy, personal therapy, rehabilitation, orthopaedics, neurology, sports training, psychomotricity, sensorimotor, massage, tactile and sensoric perception

1010607

TheraBeans All Inclusive Set

30 kg TheraBeans with Acrylbox and 2 posters.

Acrylbox 40 x 50 x 40 cm, all up weight 38 kg.

TheraBeans Bag

In these nice and practical bags you can store the fewer amount of 2,5 kg TheraBeans tidily and always ready for use. The bags and their contents are particularly suitable for senso-motor exercises and perception-therapy with little children and elderly people. Optionally an idea-folder with instructions and proposals for occupational therapy is available.

Bags made of heavy cover fabric for gym mats with a zip and carry handles on both sides, filled with 2,5 kg TheraBeans.

1010609 TheraBeans Bag red with 2,5 kg

1010610 TheraBeans Bag blue with 2,5 kg

TheraBeans®



optimal filling level TheraBeans® for arm-exercises

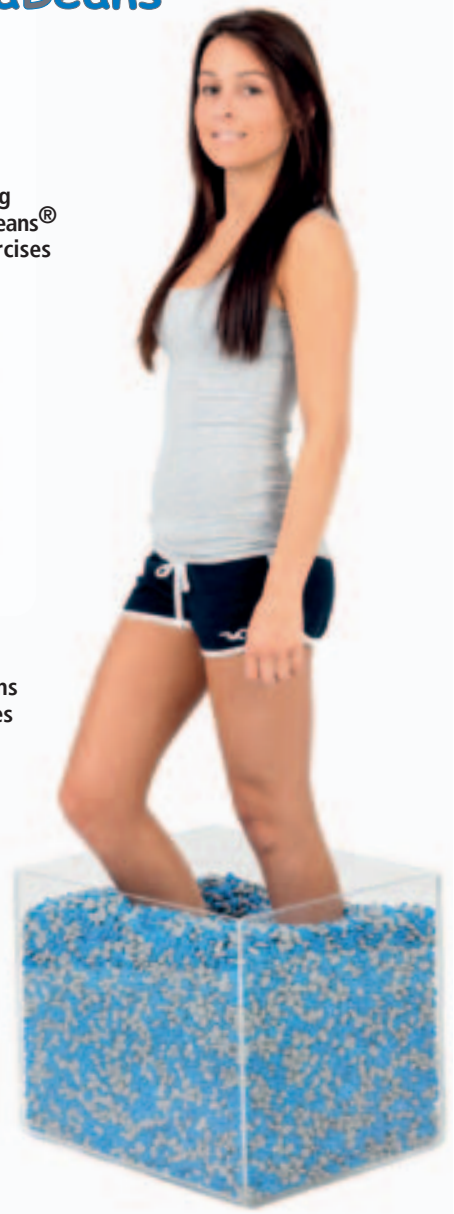

optimal filling level TheraBeans for leg-exercises

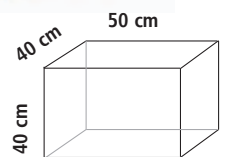

TheraBeans® Bag blue or red



HWS Trainer



VIDEO



Cervical Spine Trainer

The Cervical Spine Trainer is the latest generation of stabilization-training. Cervical spine as well as upper thoracic spine are trained functionally and efficiently, thus both are effectively stabilized.

Allowing intermuscular and intramuscular training and stimulating coordination and proprioception.

The Cervical Spine Trainer is put on the head. By doing minimal movements adjustable weight is oscillated, therefore low-lying, stabilizing muscles have to act contrary to oscillations. By this reactive training resilience of cervical spine is improved optimally.

Weight itself has an effect to trophicity of intervertebral discs and thus it has a very positive effect to the healing process as intervertebral discs are encouraged by burdening and by easing the burden.

Intensity is capable of dosing by two, optional weights, at 100 gram each, which are easily to change by bolted connection. As a result stabilization-training is ideally suited for beginners and advanced people. High-quality materials – in best workmanship- are used for producing the Cervical Spine Trainer. The mounting of the spring is made from aluminum, spring itself as well as weights and screws are made from stainless steel. Helmet is extra produced to fulfill these requirements and maximum resilience.

Fastener is easy to operate and can be adjusted individually to the head circumference. There are two versions available: size M and L (inner helmet-padding).

Field of application:

- (early-) rehabilitation
- training after traumata
- training after problems with intervertebral discs
- muscular deficits and recurrent blockades
- neurology: on numerous symptoms, which occur related to instability of cervical spine and thoracic spine muscles

1010665

HWS-Trainer M

Helmet with stainless spring.

Size: H 42 cm x W 25 /27 cm, for head circumference 57-58 cm, incl. instruction (can be used as exercise-poster) and training-DVD.

1010666

HWS-Trainer L

Helmet with stainless spring.

Size: H 42 cm x W 25 /27 cm, for head circumference 59-60 cm, incl. instruction (can be used as exercise-poster) and training-DVD.

Official website: www.hws-jakobs.de

1010655

BalanceTop C-Free

BalanceTop C-Free is a high-quality and extreme stable and heavy-duty therapy top – made from special hardened plastic material and equipped with a computer chip and innovative Bluetooth chip (wireless data transfer). Analogous to GymTop USB Professional Edition the BalanceTop software includes 12 exercises with different types of difficulty, 2 diagnostic modes, patient and exercise administration, single-run and long-term statistics plus archiving as well as 2 games.

The latest and improved third edition is either linked with supplied USB Bluetooth Dongle or with Bluetooth interface of the computer, the device runs on batteries (not included in the delivery!).

Software is selectable in German, English, French, Italian and Chinese and works with Windows 10. Designed and produced in Germany.

Ideal suited for:

- ergotherapy
- sports therapy
- children's and school gymnastic
- sport and leisure
- rehabilitation
- physiotherapy (physical therapy)
- neurology
- orthopaedics

Official website: www.c-free.de

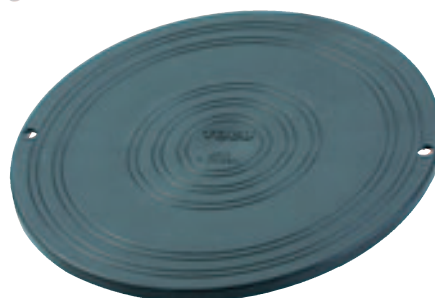
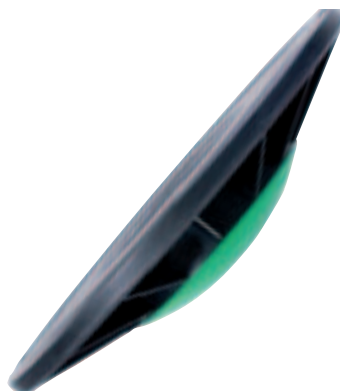

BalanceTop® C-Free Bluetooth incl. Software

GymTop[®] USB

GymTop[®] USB Therapy Top incl. Software

GymTop USB Therapy Top

GymTop USB Therapy Top is a special high quality product addressing to dysfunction of motoric control, coordination, sense of balance and muscle-function. The USB Therapy Top can easily be connected to the USB interface of your PC or laptop, it will be ready for usage within a few seconds only.

Software is selectable in German, English, French, Italian and Chinese and works with Windows 10. Designed and produced in Germany.

The USB Therapy Top provides users and patients the opportunity to develop motoric activities non-directionally, users will also learn to follow the predetermined translative and rotatory motional exercises. At the same time quality and quantity of response to special motional exercises can become observable as well as measurable. The user does not merely react to dislocation, but has to effuetate dislocations actively and systematically, thus enhancing the quality of the therapy intensely due to the fact that besides important proprioceptors optical, acoustical and tactile analysers get involved at the same time too. The USB Therapy Top is particularly suitable for effective usage in sports and leisure time, in gymnastics for children and at schools, in physical and sport-therapy, occupational therapy, orthopaedics, neurology, psychosomatic medicine, sport-exercising, traumatology and rehabilitation.

Therapy-top of high quality, tread surface with feet-marker for secure hold. 40 cm diameter, 9 cm high, for persons up to 120 kg, incl. instruction.

1010630

GymTop USB Therapy Top incl. Professional Edition

The Professional Edition provides in addition the administration for all patients and their exercises. Therefore it allows therapists to monitor their patients in a perfect way. All user information and exercises can be stored in a database. From this it is possible to prepare printable long term statistics to control and analyse the workout and thus record the progress in therapy. An integrated diagnostic mode is supporting the analysis of anatomical irregularity.

1010626

Non-Slippery Mat for GymTop USB

This mat is highly suitable as stable support for GymTop USB or any other wipp- and balance device. It helps to avoid «sideslipping» of the exercise device and makes any work out saver. Size: 48 x 48cm. Colour upon depending supply.

Official website: www.c-free.de



Therapie • Rehabilitation • Fitness • Jakobs

Non-Slippery Mat for GymTop[®] USB



www.c-free.de



Official Website for
GymTop USB, BalanceTop c-free,
Wippracer USB, Wippracer Keypad

- Updates
- Patches (64-Bit Update)
- Manual/ Evaluation

Diagnostic mode



Exercises in different levels of difficulty





Rondosum® in two Versions

Rondosum

Rondosum is an active game... Rondosum is a trainings device and - the most important - Rondosum is buzzing! Whether with a lower sound or with a louder sound depends on the kind of metal ball and is up to the players abilities to rotate or to spin the metal ball in order to create a buzzing sound. Rondosum is available in two different types: Both are made of durable, unbreakable plastic PE/PP in orange, approx. 38,5 x 5,5 cm, weight ca. 400 g, with inlying metal ball (not changeable) and instruction. For children from 6 years, for young persons and adults. The specific metal ball in both types has to achieved into a rotation movement by constant, stabilizing circular motion. This «true running» of the metal ball creates hearable buzzing sounds! That's quiet simply to learn and the combination of movement and resulting sound is always motivating and communicating positive feedback. Rhythm, pace and accordingly sound level and tone of the buzzing noise may be adapted and customized to every one's possibilities. Rondosum can be hand-held in different ways. The simplest way to hold Rondosum is like a steering wheel with both hands and bent arms in front of the upper part of the body. Playing and exercising with Rondosum will improve motor skills and coordination in a playful way and regular training shall be visible and hearable.

1013700 Rondosum with metal ball
(easier, with a noisy sound)

1013701 Rondosum with metal ball /rubbercoated
(harder, with a lower sound)

1013750

Loopliner (Utility patent DE202008017359U1)

The angled three-dimensional Loopliner is hook-and-loop-tied to the arm in a way which provides hand free. Arm and hand including fingers form a fixed line. In order to move the red wooden pearl across the wire from one end to the other, the arm is being turned, lifted and sunken into all required directions, and, if necessary, supported by full-body-movement. The movements are executed slowly, controlled and consciously (no sliding or wobbling), and they always are joint-protecting as long as they are held in a pain-free radius. Playing Loopliner means exceptional and challenging gymnastics and motor activity. Arm and body are often positioned in unexpected and unknown positions to each other. It is not necessary to think or ponder or to memorize the exercise: Body and movements are preset by the way of the wooden pearl.

Indications:

- flexibility of the shoulder joints
- improvement of neuro-muscular coordination
- eye-arm-coordination
- training of balance in combination with an unstable surface
- reactive training of the big extremity joints and of the trunk

Field of applications:

- physiotherapy (after operation, after injuries)
- ergotherapy
- generell gymnastik
- rehabilitation



Basic Looping

hand/arm-inside
(hand can support movement)



Elbow Looping Upper Arm

elbow/upper arm

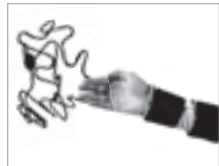

Free Palm Looping

overhand/outerarm



Prisoner Looping

hands/forearms together



Elbow Looping Forearm

elbow/forearm



Namaste Looping

hands together/
loop is turning down

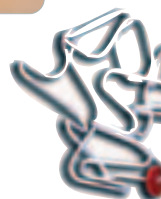
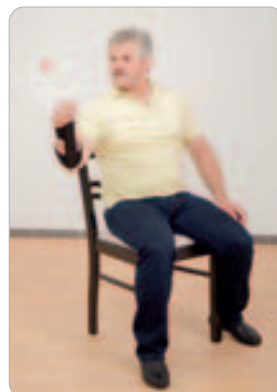

VIDEO



1013800

SwingSider Set

SwingSide is a functional trainings device enhancing and improving intermuscular and intramuscular physical condition of entire body. It allows three-dimensionally training in a 360° radius: The innovative, perfectly coordinated oscillation behaviour enhance training of shoulder joints in rotation. Optimal windings ensure wrist-protecting workout.

Excercises and training with SwingSider :

- Functional stabilization of entire body
- Training of low-lying muscles responsible for stability
- Exercising physiological spine-posture
- Neuromuscular recruitment and activation of entire body muscles
- Use in early-rehabilitation-training
- Intermuscular and intramuscular training
- Exercising reactivity of stabilising muscles
- Functional and three-dimensional training
- Suitable for all ages and fitness levels
- Ideal suited for fitness training, physiotherapy and rehabilitation

SwingSider distinguishes itself in accomplishment and function by using and processing high quality materials:

- SwingSider Set of two ergonomically shaped handholds for left and right side, each 55 cm long, length of handhold approx. 12 cm. Single weight 360 g, weight of set 720 g, total weight incl. package 980 g
- High quality materials and professionally manufacturing ensure highest quality, efficiency and safety (made in Germany).
- Delivery in deco-box, inclusive workout poster, workout video (online) and carrying bag



SwingSider®

360° Training

www.swingsider.de

VIDEO



1013972

FlexoStep (Deutsches Patent 10 2007 046 685 B4)

FlexoStep is a versatile exercise and training device to improve flexibility, strength and endurance especially for the lower extremities (lower part, leg part). The stable base and the separate footboards are shaped asymmetrically, additionally both footboards are provided with different outlined surfaces. Two different tilt angles of the base enable on both inclined levels four different positions of the footboards. This can change and adapt the extent of movement. All exercises can be performed in a seated position and thus they are practicable for physical unstable persons/patients or persons/patients at particular risk.

With detailed instruction. We recommend the use of the optional ascent support «Easy Step», which provides additive stability and security for the entire duration of exercise.

High quality plastic material, one base with two footboards, asymmetrically shaped, approx. 42 x 36 x 14cm, weight 2,4 kg, for maximum load up to 120 kg, for children from 6 years up, adolescents, adults and seniors. To be used barefooted, easy to clean with disinfectant.

Indications:

- strengthening of the musculature of the lower extremities
- improvement of flexibility of the upper ankles
- stretching of the backside of the lower leg muscles
- improvement of physical endurance performance
- equilibrium-training
- preparation for gait training
- thrombosis-prophylaxis
- vein gymnastics



FlexoStep®

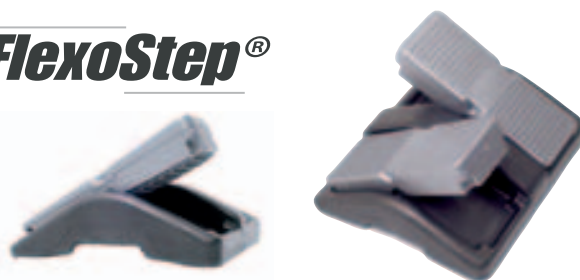

5.4.2 Neigungswinkel:

Zickzack vorne unten 10°	Zickzack vorne hoch 25°
Rundbögen vorne unten 19°	Rundbögen vorne hoch 18°
Noppen vorne unten 16°	Noppen vorne hoch 35°
Querrillen vorne unten 27°	Querrillen vorne hoch 25°

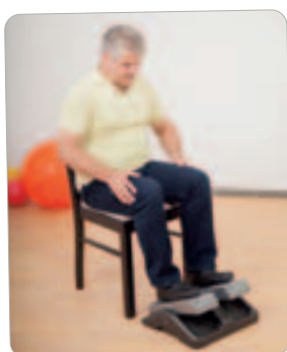

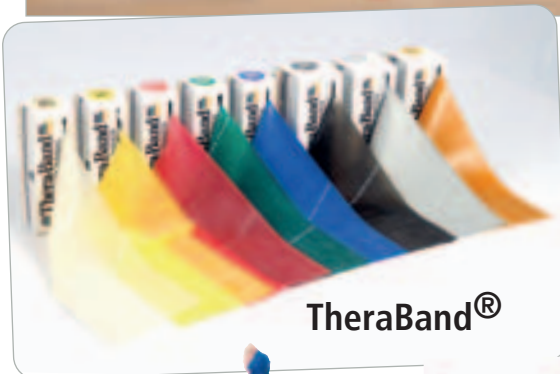

TheraBand®



TheraBand®

Easy to handle and versatile - the Original TheraBand for professional use. The flat latex tape is the ideal training device for strength and endurance training in the fields of sports medicine, therapy, popular and high-performance sport. The principle behind this progressive resistance: the farther the tape is stretched in its length the more force will be needed by the user. The resistance which needs to be overcome during the individual exercises will increase very consistently due to the high quality material of TheraBand exercising tape to provide linear strength build-up and to spare joints and prevent injuries.

- Material: 100% natural latex
- Available in 8 colour-coded resistance levels
- Desired lengths can be cut as needed

TheraBand Exercise Band 12,8 cm width, 5,50 m length

- 1220010 TheraBand tan / extra thin
- 1220020 TheraBand yellow / thin
- 1220030 TheraBand red / medium
- 1220040 TheraBand green / heavy
- 1220050 TheraBand blue / extra heavy
- 1220060 TheraBand black / special heavy
- 1220070 TheraBand silver / super heavy
- 1220080 TheraBand gold / maximum

TheraBand Exercise Band 12,8 cm width, 45,50 m length

- 1220110 TheraBand tan / extra thin
- 1220120 TheraBand yellow / thin
- 1220130 TheraBand red / medium
- 1220140 TheraBand green / heavy
- 1220150 TheraBand blue / extra heavy
- 1220160 TheraBand black / special heavy
- 1220170 TheraBand silver / super heavy
- 1220180 TheraBand gold / maximum

TheraBand Zip Bags

Thera-Band exercise band, 12,8 cm width, 2,50 m length in a handy zip bag plus instruction.

1227927

TheraBand Zip Bag Red

2,5 m Thera-Band exercise band, red / medium.

1227928

TheraBand Zip Bag Green

2,5 m Thera-Band exercise band, green / heavy.



Zip Bag with 2,5 m TheraBand®



TheraBand CLX Band

The new latexfree TheraBand CLX continues consistently the success from the popular TheraBand exercising tape. It consists of loops one after another (patented Easy Grip Loop-System). Thus allow to grip and fasten the tapes easily and provides individual handle styles and new types of training opportunities for a simple, versatile and progressive resistance training without any complex windings or knots of the tape.

TheraBand CLX provides the function of several training devices in one: Exercise tape, Loops or Tubing. Due to the clever Loop-System handle bars or door anchor are not absolutely necessary. CLX is suitable for all training-situations from physiotherapy to athletic training. Its colourcoded system complies with the well known TheraBand Exercise Tape.

- Available as pre-cut tape with 11 loops
 Length: 2 m, Width 5 cm
- Available as 22m reel for individual cuts
- Latexfree
- For moderate muscular training over the entire body

- 1223219 TheraBand CLX Band yellow / light
- 1223220 TheraBand CLX Band red / medium
- 1223221 TheraBand CLX Band green / heavy
- 1223222 TheraBand CLX Band blue / extra heavy
- 1223223 TheraBand CLX Band black / special heavy
- 1223224 TheraBand CLX Band silver / super heavy
- 1223225 TheraBand CLX Band gold / maximum

- 1222778 TheraBand CLX Reel 22m yellow / light
- 1222779 TheraBand CLX Reel 22m red / medium
- 1222780 TheraBand CLX Reel 22m green / heavy
- 1222781 TheraBand CLX Reel 22m blue / extra heavy
- 1222782 TheraBand CLX Reel 22m black / special heavy
- 1222783 TheraBand CLX Reel 22m silver / super heavy
- 1222784 TheraBand CLX Reel 22m gold / maximum

TheraBand-Tubing

The Original for professional use. Due to their unique stretching qualities and effectiveness the Tubings of TheraBand are an integral part in many applications of therapy and fitness.

Thera-Band-Tubing 7,5 m

- 1221020 TheraBand-Tubing yellow / thin
- 1221030 TheraBand-Tubing red / medium
- 1221040 TheraBand-Tubing green / heavy
- 1221050 TheraBand-Tubing blue / extra heavy
- 1221060 TheraBand-Tubing black / special heavy
- 1221070 Thera-Band-Tubing silver / super heavy

TheraBand-Tubing 30,5 m

- 1221120 TheraBand-Tubing yellow / thin
- 1221130 TheraBand-Tubing red / medium
- 1221140 TheraBand-Tubing green / heavy
- 1221150 TheraBand-Tubing blue / extra heavy

TheraBand® CLX Band



TheraBand®-Tubing



1 Pair Handles





Hand Exerciser

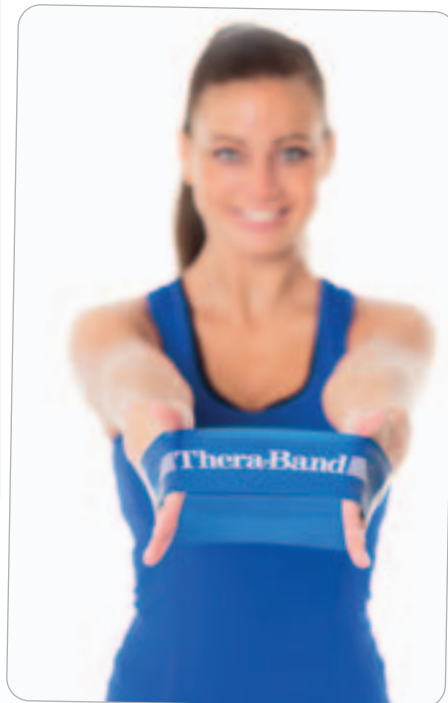

TheraBand® Loops

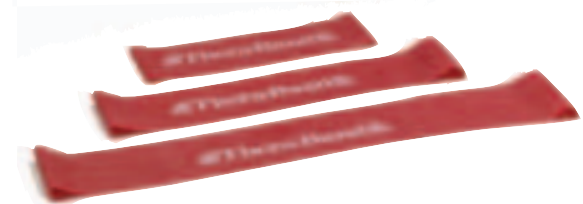

TheraBand Hand Exerciser

TheraBand Hand Exercisers strengthen finger, hand and forearm muscles. Applications as cold therapy (refrigerator) and as heat application (microwave, boiling water) are possible as well as stress reduction.

Main component polyurethane, 5 cm diameter, available in 5 different resistance levels.

1226020
 TheraBand Hand Exerciser yellow / extra soft

1226030
 TheraBand Hand Exerciser red / soft

1226040
 TheraBand Hand Exerciser green / medium

1226050
 TheraBand Hand Exerciser blue / firm

1226060
 TheraBand Hand Exerciser black / extra firm

TheraBand Loops

Effective training device with all wellknown features of Original Thera-Band Exercise Band. Available in 4 different resistance levels (yellow, red, green and blue) and in 3 different loop-dimensions/-perimeter. Particularly suitable for exercising of the lower extremities: winding or additional equipment are not required.

TheraBand Loops 7,6 cm x 20,5 cm (Ø 13cm)

- 1220810** yellow / thin
- 1220820** red / medium
- 1220830** green / heavy
- 1220840** blue / extra heavy

TheraBand Loops 7,6 cm x 30,5 cm (Ø 20cm)

- 1220811** yellow / thin
- 1220821** red / medium
- 1220831** green / heavy
- 1220841** blue / extra heavy

TheraBand Loops 7,6 cm x 45,5 cm (Ø 29cm)

- 1220812** yellow / thin
- 1220830** red / medium
- 1220832** green / heavy
- 1220842** blue / extra heavy

Gymstick Original

Gymstick Original is a simple, effective and versatile training-device for strengthening the upper and lower extremities, for stabilization exercises, execution of movement by type of sport and group training. For all exercises which can be done with free handling and furthermore for multiple joint exercises, which train specifically stabilization and coordination. It enables simultaneous, effective training of endurance, power, motility, balance, cardio-vascular functions and fat burning. For physiotherapy, fitness-club, as well as individual home-training. Gymstick Original is available in four color-marked tube-strengths.

- Material fibreglass (stick), latex (Tubings)
- Length 130 cm (assembled), 75 cm (disassembled)
- incl. 1 pair of resistance Tubings
- incl. Workout-Poster and online access for exclusive training contents
- incl. carrier bag



Gymstick™

1240001 Gymstick Original light/green

- Resistant from 1 to 5kg (light)
- Rehabilitation, therapy and fitness
- For seniors, beginners

1240002 Gymstick Original medium/blue

- Resistant from 1 to 15kg (medium)
- Fitness, returning
- Training for teenagers and women

1240003 Gymstick Original strong/black

- Resistant from 1 to 20kg (strong)
- Fitness, sportive training
- For trained men and women

1240004 Gymstick Original extra strong/silver

- Resistant from 1 to 25kg (extra strong)
- Fitness, sportive and force-oriented training
- For well-trained persons



Thera-Band Stability Trainer

Oval-shaped foam pads in 2 different sizes and densities to be used to improve joint stability and rump stability and specially to improve movement pattern, to reduce risk of falling and risk of injury.

1223305

Stability Trainer green - soft (material firmer)
 L 38cm, W 22cm, H 4,5cm.

1223304

Stability Trainer blue - medium (material softer)
 L 44cm, W 25,5cm, H 5cm.

Stability Trainer



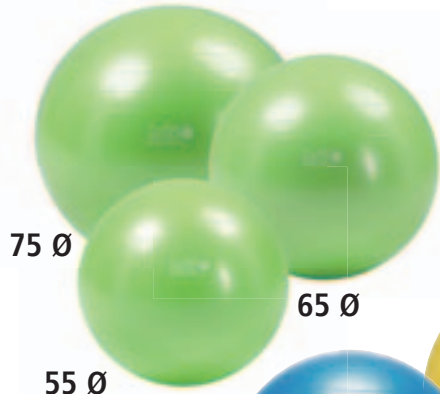

Gymnic Plus



• **BRQ Quality Balls**

The BRQ quality balls are marked with the Burst Resistant Quality logo. The specific formula prevents the ball from bursting in case of puncture - the ball deflates slowly. The BRQ system works with max. 120 kg.

4009539 Gymnic Plus 55 BRQ
55 cm Ø, lime green

4009540 Gymnic Plus 65 BRQ
65 cm Ø, lime green

4009541 Gymnic Plus 65 BRQ
75 cm Ø, lime green

4009542 Gymnic Plus 65 BRQ
65 cm Ø, yellow

4009543 Gymnic Plus 65 BRQ
65 cm Ø, anthrazit

4009525 Gymnic Plus 65 BRQ
65 cm Ø, orange

4009526 Gymnic Plus 65 BRQ
65 cm Ø, purple

4009528 Gymnic Plus 55 BRQ
55 cm Ø, red

4009529 Gymnic Plus 65 BRQ
65 cm Ø, blue

4009530 Gymnic Plus 75 BRQ
75 cm Ø, yellow

Gymnic Arte

Same product as the Gymnic Plus but with different colour pattern. The colours are added during the manufacturing procedure. The result: every ball is unique coloured! In box.

4009535 Gymnic Arte BRQ 55 cm Ø

4009536 Gymnic Arte BRQ 65 cm Ø

4009537 Gymnic Arte BRQ 75 cm Ø

Body Ball

Warm and pleasant surface, kind to the skin and therefore often used in therapy and nursing.

4009055 Body Bal 55 BRQ, 55 cm Ø, red, box

4009065 Body Ball 65 BRQ, 65 cm Ø, blue, box

4009075 Body Ball 75 BRQ, 75 cm Ø, yellow, box

4009085 Body Ball 85 BRQ, 85 cm Ø, red, box

4009095 Body Ball 95 BRQ, 95 cm Ø, blue, box



Gymnic Arte

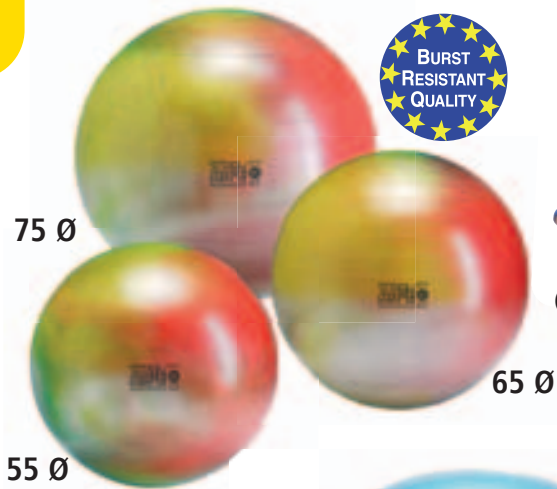

Fitball

The Fitball is the sport edition ball made in burst resistant quality for fitness, aerobic, gymnastics. It is supplied with a brochure including instructions and exercises. For more details on your training please contact your trainer or therapist.

4009505 Fit Ball 55 BRQ, 55 cm Ø

4009506 Fit Ball 65 BRQ, 65 cm Ø

4009507 Fit Ball 75 BRQ, 75 cm Ø

Body Ball

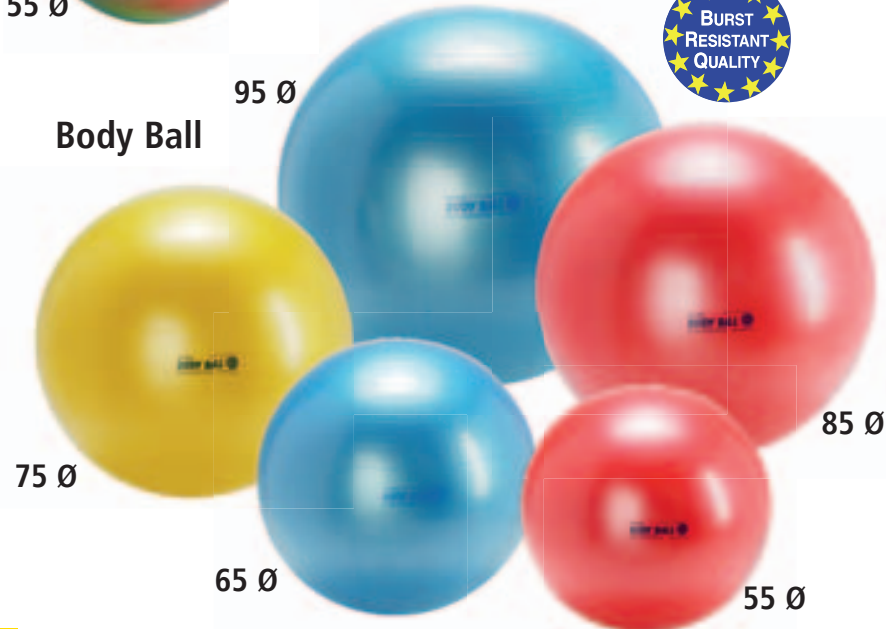

Fit Ball

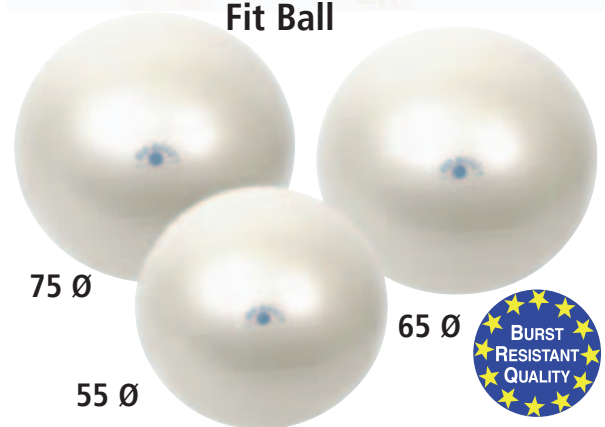



Gymnic Classic and Physio-Gymnic

- 4009545 Gymnic Classic 45
45 cm Ø, yellow, box.
- 4009555 Gymnic Classic 55
55 cm Ø, red, box
- 4009565 Gymnic Classic 65
65 cm Ø, blue, box
- 4009575 Gymnic Classic 75
75 cm Ø, yellow, box.
- 4009585 Physio - Gymnic 85
85 cm Ø, red, box.
- 4009595 Physio - Gymnic 95
95 cm Ø, blue, Polybag.
- 4009598 Physio - Gymnic 120
120 cm Ø, red, Polybag.

- Opti Ball**
- 4009655 Opti Ball 55 cm Ø, transparent, box.
 - 4009665 Opti Ball 65 cm Ø, transparent, box.
 - 4009675 Opti Ball 75 cm Ø, transparent, box.
 - 4009695 Opti Ball 95 cm Ø, transparent, Polybag.

- 4019981
Gymnic «AVANTGARDE» 65 cm Ø
silver, Polybag.
- 4019983
Gymnic Black 65 cm Ø
Polybag

Memory Ball
The weighted bottom of these balls prevents from rolling away. Ideal at the workplace and in fitness and sports.

- 4009455
Memory Ball 55 cm Ø
carton
- 4009465
Memory Ball 65 cm Ø
carton

Gymnic Classic



Physio Gymnic

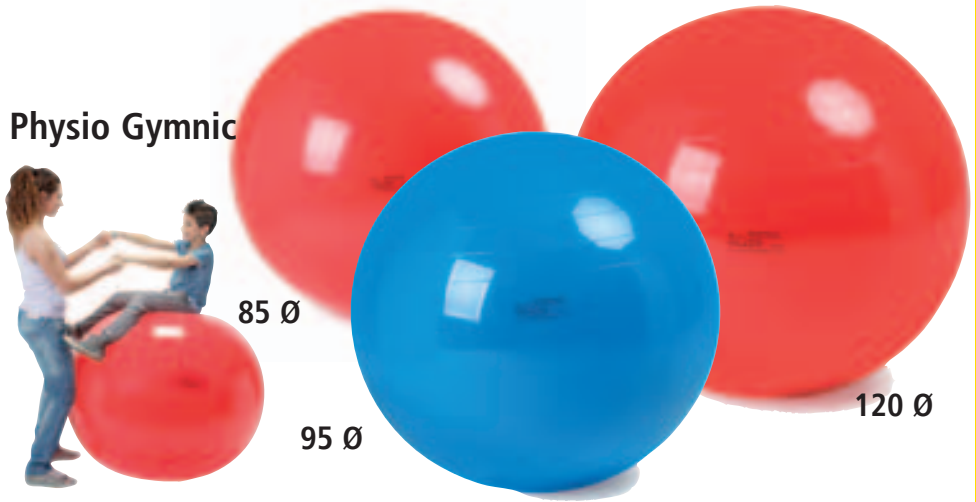

Opti Ball



Memory Ball



Gymnic Avantgarde™



Gymnic Black



Physio - Roll



Physio Roll

The «peanuts» balls are ideal for the use in therapy, especially for the work with people who have problems with balance and coordination. The peanut-shape provides more stability. The therapist can sit on the ball and support the patient's movements. Excellent dynamic alternative to the foam rolls. It is also a nice toy for kindergarten. Big in volume but light.

4008800 Physio Roll 30
30 cm Ø, 50 cm long, blue

4008801 Physio Roll 40
40 cm Ø, 65 cm long, red

4008802 Physio Roll 55
55 cm Ø, 90 cm long, yellow

4008803 Physio Roll 70
70 cm Ø, 115 cm long, blue

4008804 Physio Roll 85
85 cm Ø, 130 cm long, red

4008812 Physio Roll Plus 55 BRQ
55 cm Ø, 90 cm long, lime green

4008813 Physio Roll Plus 70 BRQ
70 cm Ø, 115 cm long, blue

4008805

Physio Activity Roll

The Activity Ball is a clear, 50 cm Ø ball with small colored balls inside that move freely when the ball is rolled or bounced. Very recommended for the use in therapy to promote three dimensional sight and coordination.

Therasensory

The classic gymball with an extra feature. The little bumps stimulate blood circulation, the reflexology zones and provide lymph drainage.

4009760 Therasensory 100 cm Ø, red, Polybag

4009761 Therasensory 65 cm Ø, turquoise, Polybag

4008806 Senso'o'Roll

Physio-Roll today supplied with a «bumpy» surface. The use of this item depends on your own needs; it can be used to make postural relaxing exercises or it can offer a stable base for stretching work or balance. Excellent for developing sensory and tactile experience. 55 cm Ø, 90 cm long, orange.

4009934 Gymnic Display

For stacking 55/65 and 75 balls. The flat strips are put together to rings. Flexible Cleanup aid for large balls. Sale per piece.

4009937 Metal Plugholder

With the Plugholder, the ball valves can be easily and quickly released.



Physio-Roll Plus



Physio Activity Roll

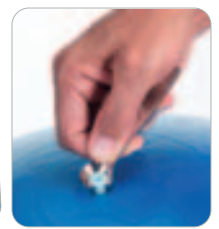

Gymnic Display

Plugholder

Senso'o'Roll



Therasensory

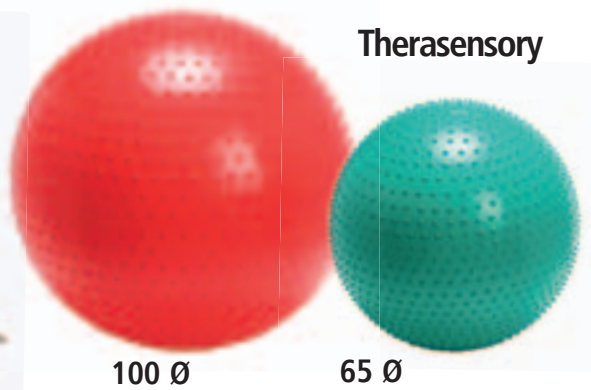



4009801 Ritmic 280 gr,
Shipping unit Set of 12, 17 cm Ø, red, yellow, blue, green.
For individual color see price-list art. 4019988 and further.

4009802 Ritmic Official 400 gr,
SU Set of 12, 18 cm Ø, red, yellow, blue, green.
For individual color see price-list art. 4019992 and further.

Heavymed
Small volume but heavy weight. In a small diameter ball there is hidden weight up to 5 kilos. The Heavy Med balls are very useful in training for a variety of team sports.

- 4009705 Heavymed 500 gr,** 10 cm Ø, green
- 4009710 Heavymed 1 kg,** 12 cm Ø, red
- 4009720 Heavymed 2 kg,** 15 cm Ø, yellow
- 4009730 Heavymed 3 kg,** 17 cm Ø, blue
- 4009735 Heavymed 5 kg,** 23 cm Ø, orange

4008093 Gym Ring Set of 4
18 cm, red, yellow, blue, green. No single colours available.

4009749 Aku Ring
17 cm Ø, red, yellow, blue, green (depending upon supply), polybag.

4009904 Steppump 3,0 L. / Volumen 1,8 L.

4009901 Handpump with flexible Tube
20cm long, with 1 ping, polybag.

4009902 Doublehubpump 2 x 2,1 L.

Megaball
This giant "Monster" ball is especially suitable for school parks, day care centers, camps, lawns and other open areas free of gravel, stones, and other sharp objects. The Mega ball encourages hours of interactive group play and invites activities such as climbing and balancing on top of the ball, rolling, kicking and bouncing. It can be used as a spring mattress if not fully inflated. Careful air compressor inflation recommended.

- 4009515 Megaball 150,** 150 cm Ø, orange, Polybag
- 4009518 Megaball 180,** 180 cm Ø, red, Polybag



Ritmic 280 g
Ritmic 400 g



Heavymed



3 kg 5 kg
1 kg 2 kg 500 g



Gym Ring



18cm Ø



Steppump

Handpump

Double-
hubpump

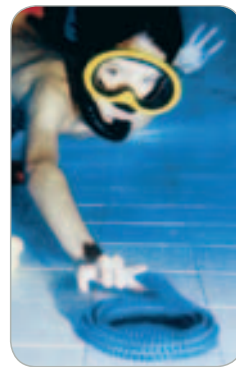

Aku Ring



15cm Ø

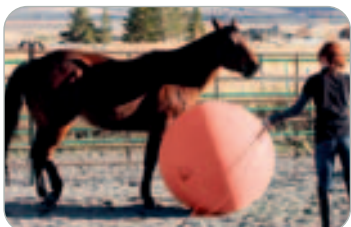

180cm Ø Megaball

150cm Ø





Over Ki Ball



4009508

Over Ki Ball

The Over Ki is used in Pilates classes and in Yoga and relaxation classes. It is used to focus the attention while movements are performed. It is a good tool in the fitness centers during the slow-motion lessons as relaxation, stretch and core strength activities. 15 cm, blue.

Reflexball

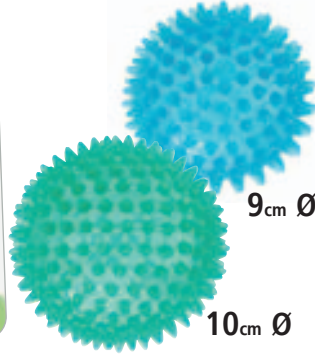
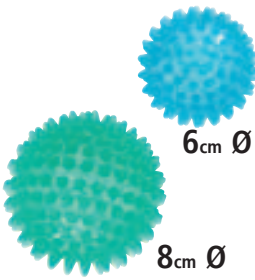

Beauty Reflex

Our Beauty Reflex are made of soft PVC with bumps. They are used for relaxing muscles, reducing tension, stimulate tired muscles. They are perfect for the body massage and to promote blood circulation.

4009763 Beauty-Reflex soft, Set of 2

8 cm Ø, orange

4009756 Reflexball

6cm Ø, 40 g, blue transparent.

4009757 Reflexball

8cm Ø, 85 g, green transparent.

4009758 Reflexball

9cm Ø, 120 g, blue transparent.

4009759 Reflexball

10cm Ø, 150 g, green transparent.

4009747

Bene Feet Mat

Offering a dynamic massage due to flexibility. Encouraging blood flow of the bottom of the foot. Foot reflexology, respective zones are stimulated and sensitized. When sitting or standing, plugged together or to be used in two parts. 23 cm x 28 cm x 4 cm, delivered in a box.

Beauty - Reflex Set of 2

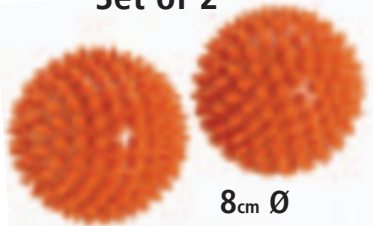

Sensyball

The Sensyball is gentle to the touch and the little bumps stimulate various pressure points while providing a good grip. Especially designed for massage, reflexology, hand and relaxation exercises. They are excellent play balls as well.

4009750 Sensyball

10 cm Ø, 70g, yellow, Set of 2 in polybag.

4009751 Sensyball

20 cm Ø 330g, yellow, w. valve.

4009752 Sensyball

28 cm Ø, 400g, yellow, w. valve.

Bene Feet Mat

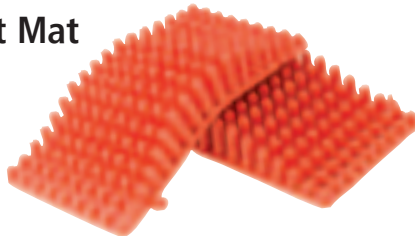
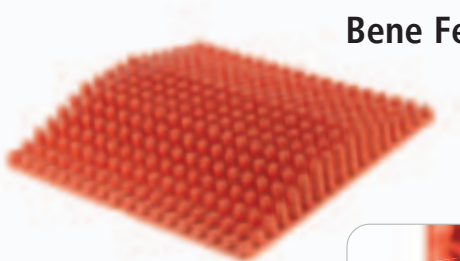

4009754

Activ Roll

Activ Roll is used for massage, reflexology, hand-therapy, relaxation exercises and foot massage. It stimulates blood circulation all over the body. 15cm long, 440g, box.



10cm Ø



Sensyball Set of 2

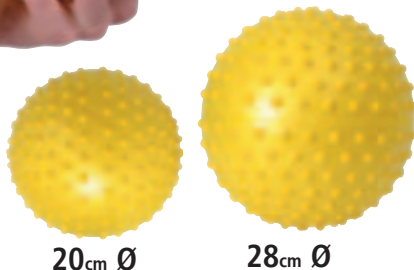

20cm Ø

28cm Ø

Activ Roll

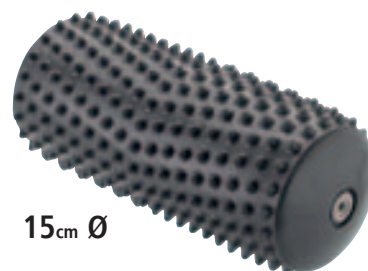

15cm Ø





Over Ball and Softgym Over

A very nice play-ball for all ages, especially for kids and seniors, because it is easy to grip and does not hurt on impact. Soft, smooth texture, very light weight and portable size. Suitable for Pilates work, children and the elderly. If not fully inflated they can also be used as a lumbar support, dynamic seating or unstable platform

4008011

Over Ball

Max. 23 cm Ø, colour sorted, red, yellow, blue. Inflatable easily with a long plug and straw, in box.

Softgym Over

Max. 23 cm Ø, Inflatable easily with a short plug and straw, polybag. Exercise brochure included.

4009311 Softgym Over red

4009312 Softgym Over yellow

4009313 Softgym Over blue

4009740

Multi Training

Versatile ball with a handy surface for many different single or group exercises. When inflated (1 kg) the ball achieves a high bouncy capacity which makes it perfect for effective various type of sports. Filled with water (up to 4 kg), the ball is suitable very well as medical training ball. 23 cm Ø, purple, inflatable or fillable with water, incl. exercise booklet.

Myo Fascial Ball

These balls have a special firmness which can be regulated as desired. They are optimal for myofasciales training on the entire body. Suitable for specific muscle activation, muscle relaxation and support of the delivery of oxygen to the tissue. In three different sizes for individual regions of the body, for example pelvis and pelvic floor. Incl. exercise booklet. Max. load 100 kg.

4008205 Myo Fascial Ball 13

Max. 13 cm Ø, 200 gr, inflatable, blue

4008206 Myo Fascial Ball 15

Max. 15 cm Ø, 300 gr, inflatable, pearl white

4008207 Myo Fascial Ball 18

Max. 18 cm Ø, 400 gr, inflatable, black

Softball

These four different balls are perfectly suited as teaching aids to learn these games - especially for youngsters. They have trendy colours and a structured surface providing a good grip. Low impact.

4008210 Softplay Hand 180 gr

16 cm Ø, yellow, Polybag, with Ago-Needle to inflate.

4008211 Softplay Volley 220 gr

21 cm Ø, white, Polybag, with Ago-Needle to inflate.

4008212 Softplay Football 220 gr

22 cm Ø, blue, Polybag, with Ago-Needle to inflate.

4008213 Softplay Basket 350 gr

24 cm Ø, orange, Polybag, with Ago-Needle to inflate.



Over Ball

Age•Years
3+ 23cm Ø



Softgym Over

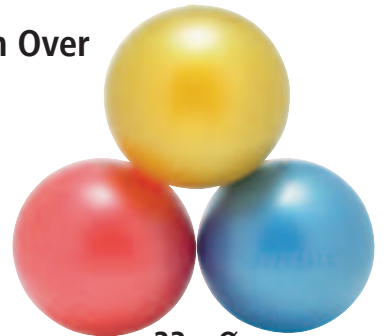

23cm Ø

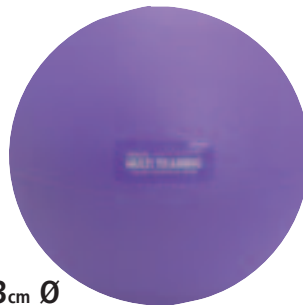

23cm Ø



Multi Training



Softplay

Age•Years
3+

Football



Basketball

Volleyball

Handball

Myo Facial Ball

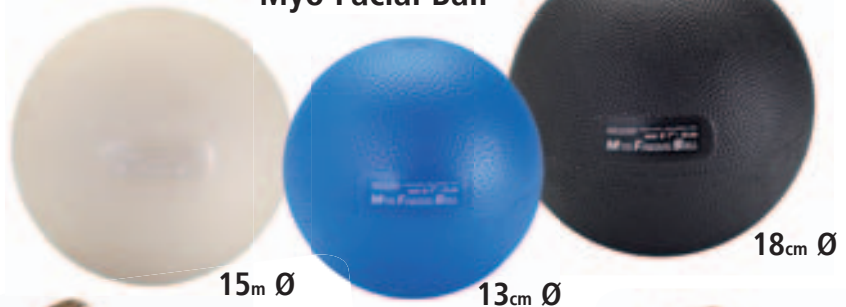

15m Ø

13cm Ø

18cm Ø



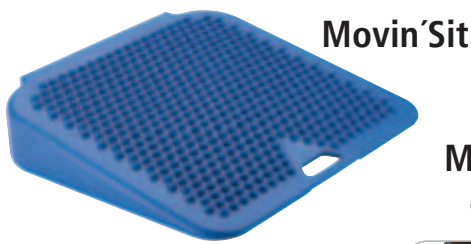

Movin'Sit

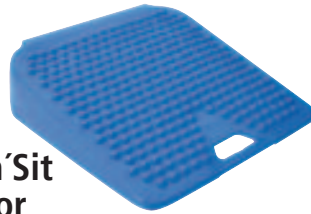

Movin'Sit Junior



Movin'Sit

The Movin' Sit & Movin' Sit Jr. are inflatable dynamic air cushions which activates intrinsic trunk muscles to support the spine. The wedge shape encourages a seated posture with a forward pelvic position and the movement makes the user feel off balance if not sitting correctly.

4008910

Movin'Sit

36 x 36 cm, blue, in box.

4008909

Movin'Sit Junior

26 x 26 cm, blue, in box, size for children.

Disc'o'Sit

With Disc'o'Sit you can seat in an active way by fitting out your chair with an inflatable cushion. It can also be used to promote active sitting and better posture on the floor as an alternative to balance boards.

4008911

Disc'o'Sit

39 cm Ø, blue, box.

4008912

Disc'o'Sit Junior

32 cm Ø, red, box.



Ball Support

Disc'o'Sit



Sit'n Gym Bälle

Sit'n'Gym perla: An exclusivity of Ledraplastic. This ball has little „feet“ to prevent from rolling away when used as a sitting ball which is very useful in offices and classrooms. If the floor has to be cleaned, the ball can be placed on the table.

4008955 Sit'n Gym 55 BRQ

55 cm Ø, red, polybag.

4008965 Sit'n Gym 65 BRQ

65 cm Ø, blue, polybag.

4008945 Sit'n Gym Jr. 45

45 cm Ø, yellow, Polybag.

4008974 Sit'n Gym Perla 45 BRQ

45 cm Ø, «Burst Resistant Qualität», box.

4008975 Sit'n Gym Perla 55 BRQ

55 cm Ø, «Burst Resistant Qualität», box.

4008976 Sit'n Gym Perla 65 BRQ

65 cm Ø, «Burst Resistant Qualität», box.

4008977 Sit'n Gym Perla 75 BRQ

75 cm Ø, «Burst Resistant Qualität», box.



Disc'o'Sit Junior



Sit'n Gym Balls



55 cm Ø



65 cm Ø



Jr. 45 cm Ø



Perla



45 cm Ø

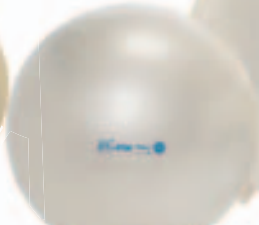

55 cm Ø



65 cm Ø



75 cm Ø

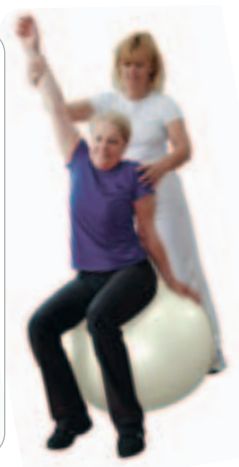



4008090
Volleyball 220 gr
21 cm Ø, yellow, in polybag.

An especially soft play-ball; very useful for exercises with kids or elderly who fear the impact of leather balls. Can be inflated to desired size without losing its bouncing feature.

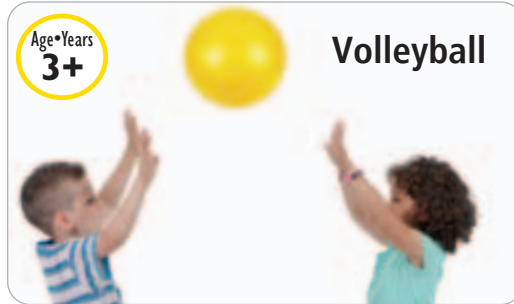

4008012
Soffy Play und Beach Ball

Super-soft, textured PVC foam material--easy to grasp and gentle on impact - Just right for play on beach. Fun for all ages - 45cm Ø size - Inflatable easily with hand pump (sold separately).



4008080
Junior Stones

14 cm Ø, Set of 6, one of each color: red, yellow, blue, orange, green, magenta, in Polybag.
These smooth hemispheres can be used to play in groups and create courses. Ideal to enhance balance and proprioception. Inflate the product with a needle pump to regulate stability.



4008089
Multiactive Stone Set of 6

16 cm Ø, made of heavy vinyl, set of six, one of each color: red, orange, green, blue, violet and yellow.
The Multiactivity Stones will stay firmly in place when stepped on. Can be used with the flat bottom on the ground while stepping on vinyl nobby bumps on the top or upside down adding additional rocking challenge while stepping on it.

4008071
Easy Grip Set of 6

12 cm diameter, 100 gr.
These easy grip balls are ideal for small hands. The raised bumps are easy to grip, which helps to develop catch and throw skills and make them also available for special needs.

4008092
Disc'o'Bocce 9er-Set

Soft, round discs for bouncing games and motoric exercises. L 95 mm Ø, set of 9, coloured sortet, in box.

4018097
Multiform Set of 16

16 elements in 4 different geometric shapes and 4 colors. To encourage recognition of colors and shapes.

Multiactive Stone



Easy Grip Set of 6



Disc'o'Bocce



Multiform Set





Hop Ball



Age•Years
5+



Age•Years
7+



Age•Years
9+

HopBalls

Hopping balls in very best quality! Made of super strong, yet soft vinyl latex-free material for long lasting use and durability. Great exercise product for indoors and smooth safe outdoor surfaces. Special patented handgrip safety handle. Maximum sustainable weight up to 200 kg. based on the size of the ball. The Oppy Balls have two separated handles, the Hop'on'Air Balls have new, fresh colours. Inflate with a hand or foot pump.

4008045 Hop 45
Age 5+, 45 cm Ø, yellow, box

4008055 Hop 55
Age 7+, 55 cm Ø, red, box

4008066 Hop 66
Age 9+, 65 cm Ø, blue, box

4008040 Hop Fantasy
Age 5+, 45 cm Ø, fantasy transparent, Polybag

4008035 Oppy 5
Age 6+, 50 cm Ø, yellow, box

4008036 Oppy 6
Age 8+, 60 cm Ø, red, box

4009602

Activity Ball

A clear, 50cm ball with small colored balls inside that move freely when the ball is rolled or bounced. Very recommended for the use in therapy to promote three dimensional sight and coordination. 50 cm Ø, transparent in box.

4009698

Jinglin'Ball

This clear ball contains four little bells which jingle when the ball is in motion. 55 cm Ø.

4008006

Gyffy

Inflatable animal looking like a little yellow giraffe. It will win the heart of young children. From 3 years up.

Raffy

Inflatable animal looking like a little hare in 2 trendy colours. For bouncing and to exercise balance and bodycontrol. For children from 3 years. L 45 cm, H 35 cm, diameter of the saddle max. 66 cm.

4008008 Raffy Lime Green

4008009 Raffy Pink

Hop Fantasy

Age•Years
5+

Oppy

Age•Years
6+

Age•Years
8+

Gyffy

Age•Years
3+

Activity Ball

Age•Years
5+

Age•Years
5+

Jinglin' Ball



Age•Years
3+

Raffy





Cavallo «Rody»

Registered by Ledraplastic since 1984. Often copied but it's still the children's favourite. Just inflate it while children are getting bigger. Max. diameter of the saddle 68 cm, red, yellow, blue and green, on box, for children from 3 years up. Instructions should be carefully followed.

- 4019959 Cavallo Rody green
- 4019960 Cavallo Rody red
- 4019961 Cavallo Rody blue
- 4019962 Cavallo Rody yellow

4008005

Rody Max

The favoured Rody in larger size for older and bigger children. Favorite with children to learn balancing and coordination while hopping. Sitting height up from 40cm according to air volume, orange, for children from 5 years up.

4007990

Speedy Base

Combined with this wheeled base a «Rody», «Raffy», «Gyffy» or «Kody» becomes a dynamic toy which is a lot of fun! Assembling it is very easy. Plastic, white, 50 cm x 32 cm.

4019999

Support Base

With a support base a «Rody», «Raffy», «Gyffy» or «Kody» becomes a rocking animal. Plastic, white, 65 cm x 32 cm.

4008001

Rock'n Rody

Support Base combined with a red or yellow Rody provides immediately an exciting ride-on toy. One Rody - red or yellow complete with the support Base in one set, from 3 years up.

4007991

Speedy Rody

Speedy Base combined with a red Rody provides immediately a rolling and pushing toy. The favoured red Rody complete with the roll base in one set, from 3 years up.

Kody

Inflatable animal looking like a little dog in 2 trendy colours. For bouncing and to exercise balance and bodycontrol. For children from 3 years.

- 4007501 Kody purple
- 4007502 Kody orange



Age*Years
3+ Rody



Rody Max

Age*Years
5+



Support Base
(without Rody)



Kody

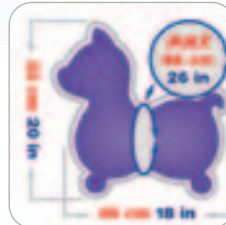

Age*Years
3+



Speedy Base
(without Rody)



Speedy Rody



Rock'n Rody



Jumper®



Jumper • Jumper Double
 You can use the Jumper for physiotherapy, functional training, personal training, group training etc. Ideal pressure distribution by proven Dynair technology, for a safety and joint protecting training. Usable on both sides, Vibration transferring to the body, also for lateral jumping movements Available in three versions.

- 9410202 Jumper (52 x 24cm), max. load 200 kg
- 9805069 Jumper Double (2 x 36 cm x 18 cm, red and green), max. load 150 kg



Jumper® double



Aero-Step XL
 The approved tool, with the twin air chamber system provides training with maximal effect. More intensive training for the deep lying musculature apperception, processing of stimuli and stability will be trained and enhanced. Very variable, applicable using on standing, kneeling, or lying down. For using in rehabilitation, fitness or at home. Over 1000 soft knobs massage to enhance blood circulation. Size: 51 x 37 x 8 cm, max. load: ca. 200 kg.

- 9400511 Aero Step XL silver-grey
- 9400512 Aero Step XL red
- 9400513 Aero Step XL black
- 9400514 Aero Step XL blue
- 9400516 Aero Step XL green



Aero Step Pro
 Aero-Step Pro is more dynamic, bigger and more versatile. It can be used both sides up and in variable standing, kneeling and lying positions. Equipped with more than 1000 Senso knobs for massage. Classic training tool with 2-chamber air-system as instable surface allows a training with maximum effect. Perception, sensori-motor function and stability will be activated and increased. Adapted for training, therapy and rehabilitation, in group fitness or at home. Size: 52 cm x 40 cm x 8,5 cm, max. load. 200 kg, with instructions and pump.

- 9400541 Aero Step Pro silver-grey
- 9400542 Aero Step Pro red
- 9400543 Aero Step Pro black
- 9400544 Aero Step Pro blue



9666700 Moonhopper Sport
 The Moonhopper for adults. Reinforced board (up to 110kg). The jumping gyroscope for excellent ankle stability. Is therapy or play time? Blue with black, ca. 50 cm.

TOGU Balance Board
 In 3 different levels red, green and blue due to different shaped radii. The Balance Board provides very effective functional training. Longlasting due to special plastic material. Low weight, maximum load 120 kg.

- 9410402 TOGU Balance Board Level 1 /red /40 x 8cm
- 9410406 TOGU Balance Board Level 2 / green /40 x 9,5cm
- 9410404 TOGU Balance Board Level 3 / blue /40 x 9,5cm

Aero Step® XL



Moonhopper® Sport



Aero Step® Pro



TOGU® Balance Board

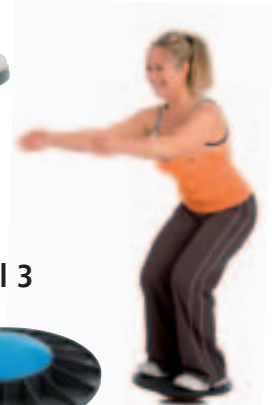

Redondo Ball

The classic Redondo Ball –soft and durable for Pilates, yoga, pelvic floor exercises and all other training programs with focus. The «foldable» ball for wellness and fitness. In sizes 18 cm, 22 cm und 26 cm.

9491300
Redondo Ball anthracite ca. 18 cm Ø

9491000
Redondo Ball blue ca. 22 cm Ø

9491100
Redondo Ball rubyred ca. 26 cm Ø

9449140
Redondo Ball Plus
The Redondo Ball in a Plus Size- specifically designed for a safe and healthful exercise. Due to its soft and handy surface the Redondo Plus provides security for balance exercises. In addition, the stability of the Redondo Ball Plus is ideal for exercises in sitting and kneeling and is particularly well suited as a dynamic support surface. Own weight 500 g, Ø 38 cm, can be in- and deflated without any pump needed.

9449190
Redondo Ball Mini Set of 2
The popular training and pilates ball in a new size and as a set of 2: The Redondo ball mini set - made in Germany - offers you a variety of new exercises. Designed as a pair it is handy small (about 14 cm diameter per ball) for a demanding body workout and health training. Due to the unique anti-slip nature of the Redondo balls, the duo is suitable for many new exercise positions and challenges. In many online videos and on training charts from Gabi Fastner, you will find numerous suggestions and motivation for your personal training at home, in the club or gym. Set of 2 in box, 2 x 14 cm Ø, colour blue, foamed Ruton.

Redondo Ball Touch
The classic Redondo Ball new with smooth Touch knobs. Easily and without using a pump to inflate and deflate. The foldable ball with knobs. Additional sensoric impressions can be set and Redondo Touch can be used for massage.

9493000
Redondo Ball Touch anthracite 18 cm Ø

9493100
Redondo Ball Touch blue 22 cm Ø

9493200
Redondo Ball Touch ruby-red 26 cm Ø

Redondo® Ball



Redondo® Ball Plus



Redondo® Ball Mini



Set of 2



Redondo® Ball Touch



TOGU® Brasil® Set of 2

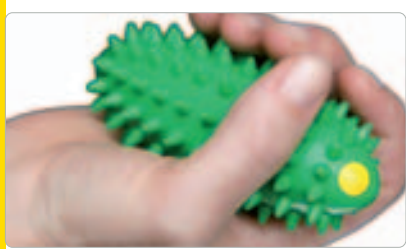

**Brasil®
"Bewegungsprofi" Set**



9470636

Brasil Set of 2

The intelligent filling of air and weight gives you specific movement feed back – the shake effect! It offers modern back-support and health training and above all else is great fun! It can only be achieved by working the deep muscle structures. To reach these deep muscles, another training programme is required which uses specific training equipment. Scientific studies have shown that the deep muscle structures in particular protect and shape the body. Green/yellow, 270g, set of 2.

- Feedback (shake effect)
- Deep muscle training for the health and figure
- Firming effects and preventative back training through minimal movement amplitude
- Uncomplicated and effective even with
- 5 minutes training a day
- Protects the joints due to the low weight: 270 g each
- Ergonomically designed, can be re-shaped thanks to air fill in

9805034

Brasil Bewegungsprofi Set

The educators of KNS – the gym, sports and dance academy – developed the new motion programme „Bewegungsprofi“ especially for schools. The fun mobility break takes 10 to 15 minutes and trains the students not only physically but mentally as well and increases their concentration and motivation. Central part of the programme is the TOGU training tool "Brasil". Contents: 1 x TOGU Brasil (Set of 2); 1 x training instructions.

9470666

TOGU Brasil Aqua

Well known Brasil also available as Brasil Aqua with safety straps which avoid to lose the Brasil during aquatic fitness. Uncomplicated and effective to use for professionals and fitness enthusiasts. Protects the joints due to the low weight: ca. 270 g each hand. Ergonomically designed.

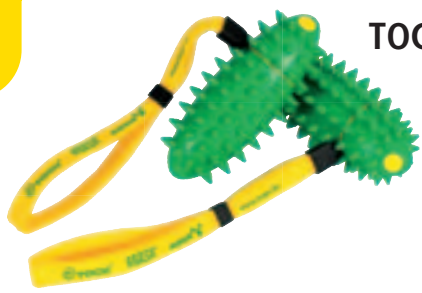

**TOGU® Brasil®
Aqua**



9470680

Bantoo Set of 2

Bantoo set of 2 are two air-filled knopped rolls made of Ruten. Bantoo activates and animates the body through the reflex zones and promotes the blood circulation. The devices are mainly used for self-relaxing exercises. Just lay the devices on the floor and roll both feet in the opposite direction on the Bantoo. One of them can be used in standing or both in sitting position. Colour red, Size: 11 x 5 cm, weight 60g per Bantoo.

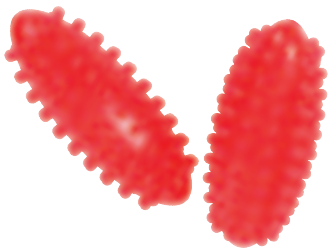

Bantoo® Set of 2



9400409

Pendel Ball

What makes the Pendel Ball exceptional is its oval form. For this reason the Pendel Ball offers more surface in contact with the ground and with the exercising person, then a normal training ball. This leads to a great advantage during full body training, because the Pendel Ball won't roll away. A wide array of applications becomes possible e.g coordination, balance, functional spinal training, fitness training, physio and ergotherapy, as well as natal preparation and back building gymnastics. Furthermore the Pendel Ball possesses a high level of bouncing characteristic. Ca. 80 cm, purple, max. load ca. 200 kg, in a box (deflated).



Pendel Ball



Senso Walking Trainer and Handtrainer plus

Multitool for Walking und Running! Walking Trainer plus fits perfectly in any hand. The flexible filling makes it comfortable soft and grippy. The «plus» trainers activate musculature in the arms, shoulder girdle and hand, promote the blood circulation of the hands, optimize flow of energy and cause a higher energy consumption because of additional weight. It is an effective help for cold hands whilst training outdoors. Approx. 250 g each, Set of 2, red or in bulk.

9470610 Senso Handtrainer plus

9470602 Senso Walking Trainer plus red, Set of 2

9470604 Senso Walking Trainer plus blau, Set of 2

9470510

Senso Handtrainer light

The «light» trainers for walking and running with air filling which makes them very grippy. The light version promotes the blood circulation of the hands, optimizes flow of energy and activates musculature in the arms and shoulders. Approx. 20 g each, coloured sorted in bulk.

9400730

Jacaranda Ball

Material: Ruten with free moving stainless steel balls inside, total weight 400 grams, 14 cm Ø.

Feel the gentle challenge by the fluent filling, air and weight. By moving the Jacaranda you are creating vibes which transfer to your body again. This enables training of your deep lying muscles. It is stabilizing our body and keeps it flexible and upright, The autochthonous back muscles, which are stabilizing the spine, the muscles of the abdomen, the pelvic floor and the diaphragm can be trained by holding, moving and controlling the Jacaranda.

Anti Stress Ball

A soft and pleasant Anti Stress Ball for squeezing, working and strenghtening the whole finger an hand musculature. The soft material causes a perfect distribution pressure on the whole palm of your hand. Very suitable for a targeted use in therapy, as well as complementary exercises to dissolve finger, hand, and lower arm strains. At the office, to overcome smoking or to reduce tension. Hygenic and washable Includes as a special feature a needle valve to adjust pressure and size. 6,5 cm Ø, in three colours.

9464100 Anti Stress Ball bue

9464102 Anti Stress Ball ruby-red

9464103 Anti Stress Ball antracit-black

9430612

Fascial Coach (incl. pump)

The air-filled Fascial Coach Ball dissolves fascial agglutinations and tensions. The gentle, skin-friendly material protects the nocception (translated: perception of pain) and prevents irritability of the structures. The degree of hardness is regulated via air supply, wich allows an individual and controlled adaptation to the need and the body region. Depending on the objective, agglutinations can be solved, tensions can be removed, the metabolism can be stimulated and the fibers can be expanded. The material Ruten is odorless and very resilient (approx. 200 kg). The Fascial Coach Ball is free of latex and contains no forbidden phthalates (EU Richtlinie 2005/84/EG).

**Anti Stress Ball
6,5 cm Ø**

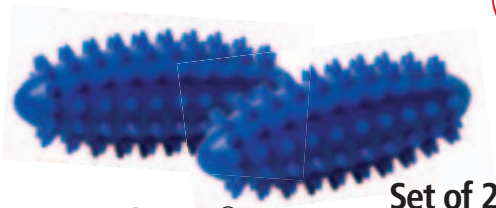

**Senso®
Walking Trainer plus**
Set of 2

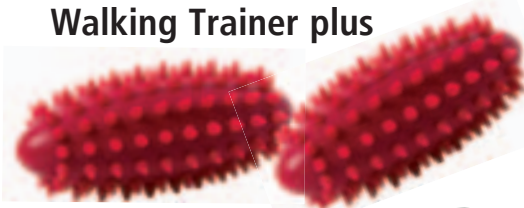

**Senso®
Handtrainer plus**



**Senso®
Handtrainer light**



14 cm Ø

Jacaranda® Ball



16 cm Ø

Fascial Coach Ball



Dynair® Comfort Wedge-Ballkissen®



9400340 Dynair Comfort Wedge-Ballkissen blue
 The air-filled Dynair Comfort cushion is made of even softer and more comfortable foamed material and easy to use on (nearly) every chair in the office, at home or on journey. The renewed shape of the cushion got an additional integrated relief zone in the center. The Dynair Comfort makes the user sit in a active and dynamic way with balance effect at the same time. Small unconscious movements are steadily necessary and lead to more balance and training of the deeper stabilizing back musculature. This can relieve back pain and support more upright position during a long work day. Ca. 40 cm x 40 cm, max. load 150 kg, blue, anthracite.

Dynair® Wedge Ballkissen® Plus



45 cm diagonal line

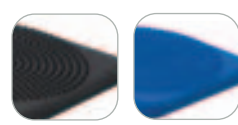

Dynair Wedge-Ballkissen Plus
 The Dynair® Wedge Ballkissen® Plus - made in Germany - is an inflated and dynamic therapy and training tool made of high-quality Ruton and is shaped like a wedge. It is a space saving alternative to an exercise ball and is being used as an unstable surface for back and fitness training. It features a needle valve for regulating the air charge. Size: ca. 37 x 40 cm. Weight: ca. 1450 g, max. load 500kg.

- 9400161 black 9400162 dark-red 9400164 blue

Dynair® Cardo® Ballkissen®



Dynair Cardo Ballkissen 36 cm x 36 cm
 Smooth, adjustable air cushion. Allows controlled dynamic sitting due to its square shape. Well suited for starting back training or therapy. Strengthens torso muscles. Keeps the vertebrae gently in motion and trains spinal musculature. Can help maintain an upright position. Especially designed for beginners and elderly, 36 x 36cm.

- 9400381 black 9400382 dark red 9400389 blue

Dynair® Ballkissen® Plus

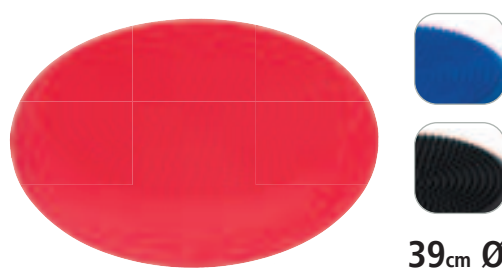

39cm Ø



Dynair Ballkissen Plus 39 cm Ø
 The Original Dynair Ball cushion in oversize diameter of 39 cm. More comfort and easy training of your back – along the way while you sit. One side with Senso knobs, the other side velvety smooth. For back training, gymnastics and rehabilitation and dynamic sitting. Max. load: ca. 300 kg.

- 9400901 black 9400902 red 9400904 blue

9400401 Dynair Ball Cushion XXL Level IV (black)
 Level IV: extra strong. The Dynair ball cushion XXL level IV is a brilliant tool for professional athletes, high level coordination and stability training. Because of a very labile design, it's a great challenge for a much better performance.

9400402 Dynair Ball Cushion XXL Meditation and Yoga (red)
 A TOGU classic with new dimensions. The Dynair XXL Meditation absorbs any motion and transforms them into small gentle movements. This enhances body awareness, breathing and facilitates concentration. Individual pressure adjustment possible.

9400404 Dynair Ball Cushion XXL Level III (blue)
 Feel and train the deeper laying musculature. Level III: strong. The Dynair ball cushion XXL level III is more difficult and labile than Dynair ball cushion with smaller diameter. It's challenging and boosts the performance for everyone to use it, because of the diameter of 50 cm. It is a perfect tool in prevention, therapy or at home. Max. load: ca. 200 kg.



Dynair® Ballkissen® XXL Meditation

Dynair® Ballkissen® XXL Level III

Dynair® Ballkissen® XXL Level IV



Dynair Ballkissen

Training back musculature and balance automatically while sitting on it. Space saving alternative to large exercise balls. For back training, gymnastics and rehabilitation and dynamic sitting. Both sides with a velvety smooth surface. Keeps the vertebrae gently in motion. Trains spinal musculature. Can help maintain an upright position. For adults in 2 sizes and 6 colors, Dynair Kids for children in 6 colors.

Dynair Ballkissen 33 cm Ø

- | | |
|---------------|-------------------|
| 9400200 terra | |
| 9400201 black | 9400208 turquoise |
| 9400202 red | 9400209 blue |
| 9400206 green | 9400150 marble |

Dynair Ballkissen XL 36 cm Ø

- | | |
|---------------|-------------------|
| 9400300 terra | |
| 9400301 black | 9400308 turquoise |
| 9400302 red | 9400309 blue |
| 9400306 green | 9400350 marble |

Dynair Ballkissen KIDS 30 cm Ø

- | | |
|---------------|-------------------|
| 9400172 red | |
| 9400175 blue | 9400178 turquoise |
| 9400176 green | 9400190 marble |

Dynair Senso Ballkissen and Senso Ballkissen XL

Training back musculature and balance automatically while sitting on it. The legendary reliable Dynair ball cushion in a Senso version. One side with Senso knobs, the other side velvety smooth. Space saving alternative to large exercise balls. For back training, gymnastics and rehabilitation and dynamic sitting. Available in 33cm and 36cm diameter.

Dynair Ballkissen Senso 33 cm Ø

- | | |
|---------------|-------------------|
| 9400270 terra | 9400271 black |
| 9400273 red | 9400275 blue |
| 9400276 green | 9400278 turquoise |

Dynair Ballkissen Senso XL 36 cm Ø

- | | |
|---------------|-------------------|
| 9400370 terra | 9400371 black |
| 9400372 red | 9400374 blue |
| 9400376 green | 9400378 turquoise |

Dynair Premium Wedge Ballkissen

Ergonomically shaped adjustable air cushion. Strengthens back muscles, can help reduce back problems and promotes upright posture. The optimized weight distribution on the thighs helps the veins. Ideal combination of ball cushion and wedge cushion in one product. Perfect to use on the office chair, at school and at home. Size: about 40 cm diam.

Dynair Premium Wedge Ballkissen

- | | |
|------------------|-------------------|
| 9400340 terra | 9400341 black |
| 9400342 dark red | 9400345 dark blue |
| 9400349 blue | |

Dynair® Wedge Ballkissen® Kids 33 cm Ø

For every kid in school and or at home during homework. Kids can move freely without losing concentration while seated. All advantages of the legendary Dynair® Ballkissen® and a wedge cushion put into one. Supports upright posture. Enough room for leaning forward. 33 cm diameter, weight 700 g, max. load 500 kg.

- | | |
|---------------|-------------------|
| 9400142 red | 9400144 blue |
| 9400146 green | 9400148 turquoise |

Dynair® Wedge Ballkissen® Kids



33cm Ø



33cm Ø



Dynair® Ballkissen®



30cm Ø

Dynair® Kids



Dynair® XL

36cm Ø



Dynair® Senso® Ballkissen® 33cm Ø
& Ballkissen® Senso® XL 36cm Ø

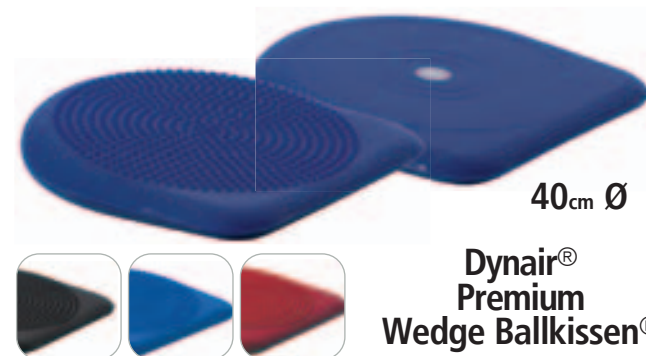

40cm Ø

Dynair®
Premium
Wedge Ballkissen®



Gymnastic Balls

- Standard
- FIG Best Quality

Powerball® ABS®

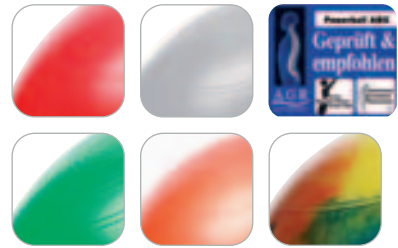

Powerball® Premium ABS®



My Ball



Clear Marina



Gloss

Marble



TOGU Ball bowl



Stacking Aid

Gymnasticballs Standard

The value priced quality in gymnastics balls for schools and associations. Very bouncy, good elasticity, anti-static.

- | | |
|----------------|----------------|
| 9430402 red | 9430403 yellow |
| 9430404 blue | 9430406 green |
| 9430412 türkis | 9430413 purple |

Gymnastics balls - FIG Best Quality

For performance sport in rhythmic sport gymnastics. Competition ball 420 g (with FIG mark of conformity). Extremely bouncy, very elastic, anti-static, good grip.

- | | |
|--------------|----------------|
| 9445102 red | 9445103 yellow |
| 9445104 blue | 9445106 green |

Powerball ABS

The large gymnastics ball from 35 cm to 75 cm: Guaranteed safety thanks to the patented Anti-Burst-System*. Each size in 6 different colours. With the classic TOGU double groove. Effective, dynamic back training. Diverse and easy. Does not roll away when you stand up. 500 kg loadable (90 kg ABS guarantee).

Powerball ABS 45 cm Ø

- | | |
|----------------|----------------|
| 9406450 terra | 9406454 blue |
| 9406451 silver | 9406456 green |
| 9406452 red | 9407460 marble |

Powerball ABS 55 cm Ø

- | | |
|----------------|----------------|
| 9406550 terra | 9406554 blue |
| 9406551 silver | 9406556 green |
| 9406552 red | 9407560 marble |

Powerball ABS 65 cm Ø

- | | |
|----------------|----------------|
| 9406650 terra | 9406654 blue |
| 9406651 silver | 9406656 green |
| 9406652 red | 9407660 marble |

Powerball ABS 75 cm Ø

- | | |
|----------------|----------------|
| 9406750 terra | 9406754 blue |
| 9406751 silver | 9406756 green |
| 9406752 red | 9407760 marble |

MyBall

Ball training at home, fun or just a pleasant change. Get the body into great shape – stretch, strengthen and mobilize. Very bouncy. Good size stability. Max. load ca. 500 kg.

My Ball 45 cm Ø

- 9414602 red
- 9414604 blue
- 9414608 turquoise
- 9404460 Gloss (transp.)
- 9414606 green
- 9414650 marble
- 9409450 Clear Marina

My Ball 55 cm Ø

- 9415602 red
- 9415604 blue
- 9415608 turquoise
- 9404560 Gloss (transp.)
- 9415606 green
- 9415650 marble
- 9409550 Clear Marina

My Ball 65 cm Ø

- 9416602 red
- 9416604 blue
- 9416608 turquoise
- 9404660 Gloss (transp.)
- 9416606 green
- 9416650 marble
- 9409650 Clear Marina

My Ball 75 cm Ø

- 9417602 red
- 9417604 blue
- 9417608 turquoise
- 9404760 Gloss (transp.)
- 9417606 green
- 9417650 marble
- 9409750 Clear Marina

Powerball Premium ABS

For guaranteed safe training and gymnastics, including additional weights, in physical therapy, gyms and studios, clubs and for home use – for adults with body weight plus additional weights up to 170kg.

- 9400460 Powerball Premium ABS 45 cm Ø, yellow
- 9400560 Powerball Premium ABS 55 cm Ø, orange
- 9400660 Powerball Premium ABS 65 cm Ø, green
- 9400760 Powerball Premium ABS 75 cm Ø, orange

9930000 Original TOGU® Ball bowl

9930500 Stacking aid set of 3

Moonhopper

Jump and hop with fun and power. The legendary hopping game. Very durable. Diameter approx. 40 cm, height 30 cm, 950 g, max. load 75 kg.

9666600

Moonhopper blue with pink.

9666800

Moonhopper green with pink.

Aero-Step

Wobbling desired – also for small children and small feet. Improve balance and coordination, increase reaction. With air-filled twin-chamber system. Training and playing with the Aero-Step becomes an experience of great fun. Size: 46 x 32 x 8 cm, AGR quality-seal, max. load: 200 kg.

9400422 **Aero-Step** red

9400426 **Aero-Step** green

9400429 **Aero-Step** blue

9465050

Senso Balance Hedgehog Set of 6 (16cm Ø)

Balance, train and have fun. Improve coordination, flexibility and body awareness. A must for balance trails. For every age. Set of 6 in red, yellow, blue, green, pink and purple, 16 cm Ø.

9465070

Senso XL Set of 2 (18 cm Ø)

Balance, train and have fun. Improve coordination, flexibility and body awareness. A must for balance trails. For every age. Set of 2 in red and blue, 18 cm Ø.

9410302 **Jumper mini**

You can use the Jumper for physiotherapy, functional training, personal training, group training etc. Ideal pressure distribution by proven Dynair technology, for a safety and joint protecting training. Usable on both sides, Vibration transferring to the body, also for lateral jumping movements. Available in three versions. 36 x 18cm, max. load 120 kg.



Moonhopper®

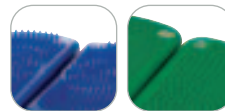

Aero-Step®



Jumper® mini



Senso Balance Hedgehog Set of 2



Senso® XL Set

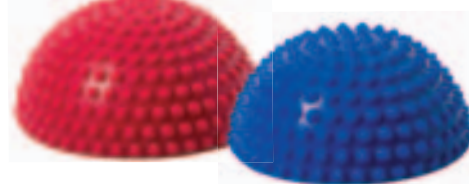



Diving Ring

Throwing Ring



Super Kick



Telestar



Ballnet

Stadion



9640000 Throwing Ring
For throwing, catching and juggling! 18 cm Ø, red, blue, yellow, green, grooved surface, needle valve.

9645000 Diving Ring 140 g
16 cm Ø, red, blue, yellow, green, plain surface. Diving training or fun at the swimming pool

9134000 Football Super Kick 8,5"
22,5 cm Ø, 300 g, needle valve. Sorted colors yellow, red and blue.

9143000 Football Stadion 8,5"
22,5 cm Ø, 420 g, needle valve. Neon-colored decoration with tamponprint, retightened lines, non-slippery surface.

9184000 Football Telestar 9"
23 cm Ø, 140 g, needle valve, decoration in screen printing, black/white.

9481007 Training Ball
Bigger balls with fewest possible weight, which causes a more slowly flight path. Perfect to exercise technical and playfully play in volley, handball and basketball. 35 cm Ø, not inflated, with needle valve, plain surface. Delivery only in packing units.

9921500 Ballnet
Very stable, big ballnet applicable for approx. 10 balls of size 9".

Earth Ball
The large ball with the Earth decoration is a classic ball for group fun events. With fewest possible weight to guarantee play. In 2 sizes, structured, transparent surface, blue with decoration.

9600500
Earth Ball 1 m diameter, 3 kg

9605500
Earth Ball 2 m diameter, 12 kg

Jump Ball Rainbow
Jump ball with an attractive decoration. Improve coordination while playing. Train musculature without even noticing. Good for the spine and posture.

Jump Ball Junior Rainbow 45 cm Ø (circumference ca. 145 cm)

9300350 Jump Ball Junior Rainbow 45, Polybag
9310350 Jump Ball Junior Rainbow 45, deco box

Jump Ball Junior Rainbow 60 cm Ø (circumference ca. 188 cm)

9350350 Jump Ball Super-Rainbow 60, Polybag.
9360350 Jump Ball Super-Rainbow 60, deco box.



Jump Ball Rainbow



Earth Ball



Coloured Balls

The coloured balls are high gloss coated with spherical screen printing all over, phthalatfree, with valve.

Punktball

- 9229050 Punktball 5,5" / 14 cm Ø
- 9229090 Punktball 9" / 23 cm Ø

Coloured Ball Rainbow

Ball with beautiful, extensive rainbow-colours.

- 9273070 Coloured Ball Rainbow 7" / 18 cm Ø
- 9273090 Coloured Ball Rainbow 8" / 20 cm Ø
- 9273110 Coloured Ball Rainbow 10" / 25 cm Ø

Coloured Ball Lucky Bug

Red with black decoration, in 4 sizes.

- 9251040 Coloured Ball Lucky Bug 4,5" / 11,5 cm Ø
- 9251050 Coloured Ball Lucky Bug 5,5" / 14 cm Ø
- 9251070 Coloured Ball Lucky Bug 7" / 18 cm Ø
- 9251090 Coloured Ball Lucky Bug 9" / 23 cm Ø

Coloured Ball Konfetti

Modern colors, transparent with colored splints, valve, in 2 sizes, colour sorted.

- 9290090 Coloured Ball Konfetti 9,5" / 24 cm Ø
- 9290110 Coloured Ball Konfetti 11" / 28 cm Ø

Knobby Catch Training Ball

Perfect for small children's hands. Good for grasping and soft to the skin! Round, pleasant knobs made of skin-friendly material.

- 9465102 Knobby Catch Training Ball red 22 cm Ø
- 9465103 Knobby Catch Training Ball yellow 22 cm Ø
- 9465105 Knobby Catch Training Ball blue 22 cm Ø

9467100

Knobby Sound Ball 10 cm Ø

The chiming toy with good grip! Its extra long knobs stimulate the tactile sensory perception perfectly. Non-springy.

9410130

TOGU Reactionball

Start to train speed and reaction ability with the TOGU reaction ball - made in Germany. At each landing the ball bounces in another direction. Improves also the eye-hand coordination. The special shape makes the jump direction unpredictably. Unlike other reaction balls the TOGU reaction ball has a valve and therefore the degree of difficulty can be regulated additionally with a ball pump. The material Ruton is extremely resistant, durable and 100% recyclable. Size ca. 12 cm Ø, colour sorted red or blue, max. load up to ca. 150 kg.

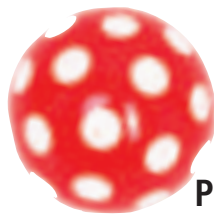

Punktball



Lucky Bug



Rainbow



Konfetti



TOGU Reactionball



12cm Ø

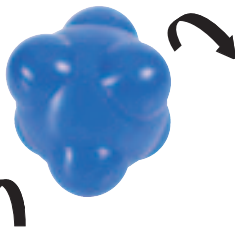

22cm Ø

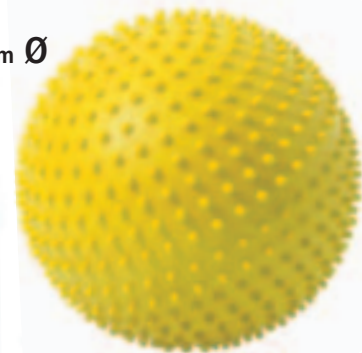

Knobby sound ball

10cm Ø

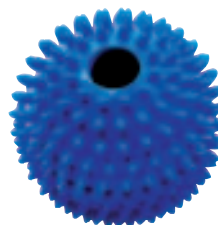

8700209

WINTHER C29

C29 is the new urban delivery bike which unites the best of two worlds – the 1950' Short John combined with the dynamics and speed of mountain and city bikes. It offers excellent riding capabilities and attention is paid to every detail from the protection bars on the front loader to the kickstand stop and damper.

Delivery Bike C29



C29 – DESIGNED TO CARRY GOODS WITHOUT COMPROMISING ON SPEED

The T6 heat treated aluminum frame and front loader has an organic, masculine look. The front loader is specially designed, made for carrying up to 50 kg. It is very stable and when parked it is supported by the CrMo steel kickstand. The sliding replaceable dropouts provide flexibility by allowing different 'sliders' to be mounted.

C29 – ATTENTION PAID TO EVERY DETAIL

All the C29 components are handpicked, from the grips to the flat pedals including FSA The Big Fat Pig 1.5R headset. This adds to the high durability of the frame and supports the dynamics and speed of C29. The wheel size is a deliberate choice; 29" rear wheel and 24" front wheel. The Schwalbe Big Apple tires are chosen for the built in suspension.

C29 – AN INDIVIDUAL CHOICE

The billboard provides an option to customize the C29 to the individual whether it is for business or private use. It comes in two standard colors: Jet Black or Artic White. The gear options are Sram Automatix 2 gears or Shimano Alfine 8 speed. Hydraulic disc brakes are standard. It is a highly durable bike which is assembled by hand in Denmark.

Dimensions

- Length: 1940mm
- Handlebar wide: 600mm
- Handlebar height: 1100mm
- Weight: 22kg

Wheel

- Rims: Alloy rim, DM300 A rim
- Tires: Schwalbe Big Apple
- Frontwheel: 50-507
- Rearwheel: 50-622
- Rear hub: Sram Automatix 2 gears/Alfine 8
- Tubes: Schwalbe

Components

- Headset: FSA – THE BIG FAT PIG 1.5R No. 7BY
- Billboard: Dibond sandwich bracket
- Fenders: Sunny wheels SW-FA 111-50
- Stem: Bar - Bore 31.8mm

Frame

- Frame: T6 heat treated 6061 aluminum
- Front loader: T6 heat treated 6061 aluminum
- Kickstand: CroMo steel
- Fork: Hi-ten 11/8 steerer tube
- Colors: Jet Black
- Handlebar: 31.8 x 660 BS: 6°
- Grips: HERRMANS® Diamond Lock DD28, Rise: 20mm, matt black
- Brakes: Hydraulic Disc brakes
- Seat: Cionlli Black
- Seat clamp: 34.9mm
- Seat post: 30.9 x 300 offset 20mm
- Chain: KMC anti rust
- Crank set: 38T /175 w. alloy chain guard
- Pedals: WELLGO – LU-A52

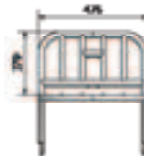

Marlin Bicycle Trailer



8985199

Winther Marlin Bicycle Trailer For 1-2 children

Modern, racy and practical design

- Spacious transport cabin with large viewing windows
- Large storage space on the back side
- The hood is suitable for all seasons and all weather conditions
- Foldable frame - front to rear - for maximum safety

Focus on safety

- Comfortable seats with adjustable, padded 5-point seat belts
- Reflector stripes along the cabin and on the wheels
- Safety flag for additional security
- Double parking brakes

Sturdy frame and wheels

- Tubular steel frame in high strength, strong quality with durable powder coating
- Quick-release wheels with closed hubs
- 20 x 1.75 lightly running pneumatic tyres
- Trailer coupling with quick coupling for easy and safe installation

Dimensions:

- L x W x H: 1150 x 658 x 870 mm
- Interior cabin size: 580 mm

Optional accessories

- Jogger Set
- Rain hood



We publish regularly throughout the year our magazine **Jakobs® interaktiv**, which we distribute to all our Jakob's customers. In this magazine, we provide information about new products, current trends and important changes in a concentrated, clear presentation.

Index

Acryl box 67, 161
 Actiroll 154
 Activity Ball 178
 Activity Rings 53
 Activ Roll 174
 Aero Steps 180, 187
 Air Board 50
 Air compressor 77
 Air pumps 173
 Aktiv vehicles 36-41
 Aku Ring 173
 AllBalls 82
 Aluminium Goals 75
 Anti Agression Bats 60
 Anti Stress Ball 184
 Apitor Super Bot Robotic System 99
 Arches 48
 Athletic Mats 152
 ATV All Terrain Vehicle 139

Baby Dolls 88-89
 Baby Gymnastic Mats 152
 Baby Trampoline 54
 Badminton Net, Racket & Shuttlecock 79
 Balance Board 180
 Balance Hemispheres 45, 157, 162-163, 187
 Balance Rope 155
 BalanceTop C-Free 162
 BalanceTop System 162
 Balancing Board 46
 Balancing Board (wood) 48, 100
 Balanco System 64-65
 Ball bowl 186
 Ball-Carousel Rondogo 70
 Ball carrying bar 74, 156
 Ballkissen 176, 184-188
 Ballnet 188
 Ball-pools 153

Ball pumps 173
 Ball Run MagniRoll 119
 Ball Support 176
 Balls, see Play- or Sportballs
 Bantoo Set of 2 • 182
 Baseplates 98-99
 Basketball 175
 Bean Bags 156
 Beanless Airbags 79
 Beauty Reflex 174
 Bene Feet Mat 174
 Benhur tricycles 15, 20
 Bicycles 22, 38, 190
 Bicycle Trailer 32, 190
 Bike Helmet 22
 Bike Runner 11, 17, 23, 35, 38
 BIG BRICKS Plates 98
 BIOBUDDI Building Blocks 103
 BIO PLAST Dantoy 132-133, 137, 141
 Blackroll, diverse 154
 Blindfolds colored 84
 Blowing games 106
 Blow Lotto 106
 BobKart 29
 Body Ball 170
 Body Wheels 51
 BoundaLoons 83
 Boxing Base 61
 Brasil Sets, div. 182
 Bubabloon 84
 Buggy Jakobs aktiv 41
 Buggy 4 Kids 6
 Building Carpet Tretford 146-149
 Building Cups 132, 135
 Building Kit Colonia 151
 Building plates 98-99
 Build'n Balance Sets & Accessories 44-45
 Bulldozer 138

Caborunner 10-11
 Calm before Storm cardgame 85
 Canvas Tube 58
 Cardholder 111
 Carousel 54
 Car Park 138
 Carpets 146-150
 Catch Ball 83
 Catch Training Ball 189
 Cavallo Rody 179
 Cervical Spine Trainer 162
 Challenge Vehicles 25-27
 Circle Bike 26
 Climbing Ropes 59
 Clown's Hat 52
 CLX TheraBand 167
 Colonia Building Kit 151
 Color Slit Game 96
 Coloured Balls 189
 Colour Palettes 130
 Contact Ball SuperSafe 77
 Contura Top 67, 160
 Contura Trail 62
 Cushing for MiniTop 55
 Cycle Rack VIKING 24

DANTOY- products 132-141, 144
 Delivery Bike WINTHER 190
 Digger 26, 133, 138
 Disc'o' Booce 177
 Disc o Sit- items 176
 Diving Rings 188
 DokuMag 115
 Dolls and Accessories 88-93
 Dolphin 32
 Dominos 96
 Donkey 32
 DORON Wooden Puzzles & Games 94-97
 Doublehubpump 173

Drums (Steel Tongue Drums) 122-123
 Dynair Ballkissen 184-185

Earth Balls 188
 Easy Rider 16, 19, 31, 36
 EasyTip, EasyTip Magnet 109
 ECO Iron Beads 131
 Educational Dice 75
 Eggclock Balls 84
 Elefant & Gator 85
 Elefant Skin Foamballs 156
 Emotion Balls 81
 E-Turtle (with motor) 5
 Explorer vehicles 28-31
 E-Z Balls 82

Farm Animals Wall Unit 128
 Fascial Coach Ball 183
 Fascial Rolls 154
 Fiery Spirit 70
 Figure of 8 • 66
 Finger Lights 81
 Finger Loop Set 87
 Fish 52
 Fishing Games 52, 104
 Fishing Rod 52
 Firetruck Jaalinus 33
 Fit Ball 170
 Fitness Training devices 165-169, 180
 Flat Hoops 56, 157
 FlexoStep 165
 Football 59
 Floor Surfer 46
 Fluffballs 80
 Fluttering Ghosts 70
 Foam Balls 76, 156
 Foam Cubes 75, 102, 150
 Foam Football 76

Foldable aluminium goals 76
 Footballs 76-77, 188
 Footgolf 73
 Footmuff 6
 Footpumps 173
 Foot Twister 25
 Forest Animals Wall Unit 128
 Forest Spirit 70
 Fortuna- Soft Mat Kit 151
 Four Wins 125, 127
 Fumbling Blanket 87
 Fun Cars 138
 Funcart 21, 29
 Funracer 29
 Functional Bricks 57
 Function Cones 56
 Fußballgolf 73
 Furniture glides tretford 148

Game Balls 76-84 170-177, 181, 183 186 188-189
 Garden Bed 144
 Gardenset 144
 Garden Tools 142-144
 Giant Air Board 50
 Giant Blocks 136
 Giant Catch Tail Balls 78
 Giant Puzzle 94-95, 113
 Go 4 • 111
 Goal Ball Trainer 84
 Goals 59, 73, 76
 GoGo, GoGo Bus 49
 Gonge Products 42-55
 Gonge Top 55
 GrabBalls Rubber Flex 80
 Grab-N-Balls 84
 Grotto Grip 105
 Guffy Hop Animal 178
 Gymnastic accessories 155-157
 Gymnastic Balls small 155, 179
 Gymnastic Balls large 170-171, 186

Gymnastic items 155-157
 Gymnastic mats 152
 Gymnastic rings 156, 173
 Gymnastic ropes 155
 Gymnic Display 172
 Gymnic- Products 170-179
 Gym Rings 156, 173
 Gymstick TheraBand 169
 GymTop Multiplex 160
 GymTop Therapy Top 48, 67, 160
 GymTop USB Therapy Top 163

Handballs 175
 Hand Exerciser TheraBand 168
 Handpump 173
 Hand Top Set 129
 Hand Twister 26
 Heavymed Balls 173
 Hemisphere 45, 157, 177, 187
 Hemisphere Stilts with cord 45
 Hilltops 47
 Hop Animals 178-179
 Hop Balls 178
 Hopsacks 60
 Hovoboard 158-159
 Hula Hoop 79
 Hula Hoop Target Set 78
 Hurdle, adjustable 77
 HWS Trainer 162

Indoor football soft gliding foam half 77
 Impact Protection for SwingTop 59
 Iron Beads 130-131

Jaalinus vehicles 33-35
 Jacaranda Ball 183
 Jakobs aktiv Line 36-41
 Jakobs' Figure 8 • 66
 Jakobs Products 6, 10-11, 33-41, 56-75, 86-87, 98-99, 102, 105-106, 108-120, 122-131, 145, 150-165
 Jakolino 111
 Jinglin Ball 178
 Jolly Support 57
 Juggling Hat 70
 Jump balls 178, 188
 Jumper, Jumper double 180
 Jumper mini 187
 Junior Stones 177

Kaleidoscope 96
 Kangaroo 21
 KEA - Display stand with exercises for school lessons 74
 Kendo Bat 61
 Kiddy Busses 4-9
 Kiddy Tricycles 12-16, 18-21, 27, 29-31, 33-34, 36-37, 39
 Kids Dolls 90
 Kitchen Toys 132-133, 140-141
 Koala 54
 Kody Hop Animal 179
 Knobbly Balls 189
 Knobs Puzzle 95
 Kreiselstein 68-69
 Kubb-Game 72

Language Improvement Set 107
 LEGO DUPLO Special Set 103
 LEGO Special Set 103
 LEGO Playtable 102
 Light Stax 100-101
 LoGeo 114
 LoGeo Wall unit 114, 125
 Logopedics 105-107
 LooPliner 164

Loops TheraBand 168
 Lunch Set 132

Magic Circle 155
 Magic String 155
 Magic Scarves 42
 Magna Bands 116
 Magna Disc games 116
 Magna Shapes 117
 Magna Sticks games 117

Magnetic Wooden Blocks TEGU 121
 Magnetic Fishing Set 52, 104
 Magnetic Games Wood 109-110, 114, 121, 126-127
 Magnetic Table 120
 Magnet Rallye 118, 126-127
 MagniRoll Ball Run 119
 MagPad 118
 Manhattan Tower 110
 Marker Ribbon 61
 Massage Roller 154
 Maxi Rolletto 71
 Mega Balls 173
 Mega Tunnel 58
 Mera-Floorball 59
 MimiQ Cardgame 106
 Mini air compressor 77
 Mini Soccer Goals 73
 Mini Stilts 53
 Mini Top 53
 Mini Viking Wheelers 12-17
 Molten Softballs 156
 Mono-Fling 83
 Moonhopper 187
 Moonhopper Sport 180
 Moos-rubber Throwing Balls 74, 156
 Motor Activity Sets 57
 Motorcycles 139
 Motoric Sets 57
 Mountain 46
 Mouth motoric-products 85, 106
 Movecubes 75
 Movin Sit-items 176
 Multi Action Set 57
 Multiactive Stones 177
 Multi Form Set 177
 Multi Motorik Set 57
 Multi Training 175
 My Ball 180
 «my little story» 105
 Myo Facial Ball 175

Night Light 86
 Necesso Bats 60
 Neon Ropes 155
 Non-Aggression Bats 60
 Non-slippery Mat for GymTop 163

OFF-ROAD vehicles 30-31
 Oilstation WINTHER 27
 Open Pencil Cases 130
 Oppy Balls 178
 Opti Balls 171
 Over Balls 175
 Over Ki Ball 174

Paddle-Set 71
 Pänz Kids Sitting Cubes 150
 Pan Sledge 136
 PanTastino 112
 PanTastino corpo 112
 Parachute-Pack 82
 Parachutes 42, 82
 Pebble Sailors 78
 Pedoball 62
 Penny Farthing 28
 Phoenix Stapelstein 68

Physioballs 171-172
 Physio Gymnic 171
 Physio Rolls 172
 Pine Wood Sport Staff 157
 PlasmaCar 24
 Play & Sport Balls 76-78, 80-84, 153-154, 156, 170-188
 Play Caterpillar 58
 Playcarpet City 150
 Playcups 132, 132
 Playpen Balls 153
 Playtables 102, 120
 Plugholder 172
 Plus-Balls 170-172
 Poco Ball 78
 Pogo Bouncer 79
 Poles 56, 157
 Police aktiv vehicle 41
 Police Scooter and Racer 139
 Pom Pom Balls 80
 Porcupine Massage Balls 156, 174
 Powerball ABS 186
 Power Premium ABS Ball 186
 Pullcart 137
 Pulling Rope 155
 Pumps 173
 Pursuit Ball Team Game 76
 Push Wagon 39
 Pushbikes 13, 15, 34, 38
 Puzzle 94-95, 97, 113
 Puzzle 3D for building bricks 97
 Pyramid Beanbags 77

Raffy Hop Animal 178
 Reaction Ball 189
 Redondo Balls 181
 Reflex Balls 174
 Retro Throwing Game 72
 Rhythm Bands 157
 Rhythm Flags 82
 Rickshaws 17, 22, 40
 Ring Toss 43
 Ritmic Balls 173
 River, Island, Bridge 47
 River Landscape 47
 River Stones 46-47
 RoadRunner 105, 126-127
 Robo-Board 49
 Rock Around 46
 Rody, Rock'n'Rody 179
 Rody Max 179
 Rody Speedy Base 179
 Roleplay Toys 133, 140-141
 Rolleppo 66
 Roller 49
 Rolletti-Rolling Boards 71
 Rolling Boards 71
 Rollinto, Outer/Inner Roll 153
 Rondogo Ball-Carousel 70
 Rondosum 164
 Rotonda Juggling Hat 70
 Round Carpets with Overlock 147-148
 Round Seesaw 53
 RowKart 21
 RubberFlex GrabBalls 80
 Rubens Barn Dolls 88-93
 Rubens Barn Original 93
 Rubens Cutie 92
 Rubens Eco Bud 91
 Rubens Kids 88

Sack Barrow 17
 Safari Stapelstein 68
 Safer Pogo Bouncer 79
 Safety Roller 23, 39
 Safety Scooter 13
 Safety Straps 64
 Samba Rope Pulling 58
 Sandpit Toys 132-139, 144-145
 Scooter 16, 23, 31, 35, 39, 139
 Scooter Paddle 71
 Seat and Impact Protection

for SwingTop 59
 Seat Pads Tretford 147
 Seesaws 53, 136
 See-Through Tunnel 58
 Sensation Ball 81
 Senso Balance hedgehog 187
 Senso'o'Roll 172
 Sensory Blanket for Mini Top 55
 Sensory Floor Tiles 85
 Senso Walking Trainer 183
 Sensyball 174
 Shoes for Koala 54
 Shole of Fish 52
 Sit'n Gym Balls 176
 Sitting Balls 170-171, 176, 186
 Sitting cube 150
 Skipping Ropes 155
 Snow Shovel 136
 Speedy Base Rody 179
 Soccer Balls 76-77, 175, 188
 Soccer Goals 73, 76
 Soffy Play Ball 177
 Soft Hook-N-Loop Balls 78
 Softballs 76, 156
 Softgym Over 175
 Soft Mat Kit Fortuna 151
 Softplay Balls 175
 Soft Weighted Hula Hoop 79
 Sound Ball 189
 Spider Ball 80
 SPORDAS Products 75-88
 Sport Balls 76-78, 80-84, 153-154, 156, 170-188
 Springy Rackets 83
 Stability Trainer TheraBand 169
 Stackin Aid 186
 Stamp abouts Set 72, 137
 Standing and active board
 Hovoboard 158-159
 Stapelstein 68-69
 StarScooter 31
 Steel Tongue Drums 122-123
 Steppumps 173
 Stilts 53
 Storm games 106
 Storm in a word 106
 Street Playcarpet 150
 Stroller 6, 41
 Success Balls 81
 Sulky 17, 22, 40
 Summer Skis 53
 Super Foam Swing and Hoop Set 83
 Super Foam Ringz 78
 Super Safe Balls 76-77
 Super SoftTouch Balls 76
 Surekatch Ball 80
 Swingcarts 24
 Swing-Rope 155
 SwingSider 165
 SwingTop 59

Tactile Discs 43
 Tactile Sense Game Voezie 113
 Tandem Bike Runner 23
 Taxi 15, 20, 35, 40
 Teamvests 76
 Teether Ring Chain 132
 Teether Rings 132
 TEGU Magnetic Wooden Blocks 121
 Tetrolino 118, 129
 The River/ The Island/ The Bridge 47
 The Senses Game 106
 TheraBand Products 166-169
 TheraBeans 67, 161
 Therapy Balls 170-171, 186
 Therapy Top 48, 67, 162-163
 Therasensory Balls 177
 Throwing Games 43, 72
 Throwing Game Retro 72
 Throwing Rings 188
 Tip Express 111
 TOGU- Products 154, 180-189

TOLO Products 104
 TONGO-GO Steel Tongue Drums 122-123
 Tops 55, 67, 124, 160, 162-163
 Trailer WINTHER 14, 20, 22, 32, 37, 190
 Trampolines 54
 Travel in Europe Wall unit 125
 Tretford Carpet 146-149
 Tricycles 12-16, 18-21, 30-31, 33-38, 41
 Trucks 21, 33, 133, 139
 Tryangle Domino 95
 Tubing TheraBand 167
 Tunnel 58
 Turbino 106
 Turtle Kiddy Busses 4-9
 Twin Taxi 20, 41
 tyni BIO Products dantoy 132

Unihockey 59
 U-Rider 29

Vario Wooden Puzzles 106
 Vehicles Wall unit 128
 Via Maxima 108
 Via Mobile 108
 Via Ronda 108
 Viking Game (Kubb- Game) 72
 Viking Wheelers 18-24
 Voezie The TactileSense of Touch 113
 Volleyball 77, 175, 177

Walkabout vehicles 27
 Walkdollies 72, 136
 Walking Trainer 183
 Wall units 114, 124-129
 Wall Rack Viking 24
 Wall Tops 124
 Water Column 86
 Water Spirit 70
 Wedge Ballkissen 184-185
 Weightballs 173
 Wheelbarrow 14, 22, 137, 143
 WheelyRider 27
 Whisper Phones 107
 Wide Base Scooter 16
 Willow Cabins 145
 Wings of Color 97
 WINTHER vehicles 4-32, 190
 WippSider 48, 63
 WippWalker 48, 63
 WippSider PRO 63
 Wooden Beads 1kg 131
 Wooden box 112
 Wooden Gym Clubs 156
 Wooden Gym Hoops 157
 Wooden Hemispheres 157
 Wooden Knobs Puzzle 94-95,
 Wooden Puzzle Realistic 95, 97
 Wooden Sports Staff 157

XL-Iron Beads 130-131

ZigZag Wall unit 126, 127
 Zlalom Tricycle 30



The right to constructive modifications, changes in structure, design and colour is reserved, misprints and errors excepted.

The right to use any photo in this catalog belongs to Jakobs GmbH and can only be used exclusively by permission of the copyright owner.

Warranty of delivery guarantee for trading goods do not apply for goods of which production will end during the validation-term of this catalog.

This catalogue supercedes all previous catalogues.



Jakobs®



Jakobs® GmbH

Lieferanschrift:
Am Mittelweg 3
D - 52388 Noervenich

Postanschrift:
Postfach 66
D - 52386 Noervenich

Tel + 49 (0)2426 904 66 - 0
Fax + 49 (0)2426 904 66 22
info@jakobs.de

www.jakobs.de

www.jakobs-education.de
www.hovoboard.de

Verkauf nur über den Fachhandel

DE

